

wardell-armstrong.com

ENERGY AND CLIMATE CHANGE  
ENVIRONMENT AND SUSTAINABILITY  
INFRASTRUCTURE AND UTILITIES  
LAND AND PROPERTY  
MINING AND MINERAL PROCESSING  
MINERAL ESTATES  
WASTE RESOURCE MANAGEMENT



**SILVER BEAR RESOURCES PLC**

**NI 43-101 TECHNICAL REPORT**

**MANGAZEISKY SILVER PROJECT MRE UPDATE AND STRATEGY RE-ASSESSMENT,  
REPUBLIC OF SAKHA (YAKUTIA), RUSSIAN FEDERATION**

**10 November 2021**



**DATE ISSUED:** 10 November 2021  
**JOB NUMBER:** RU10139  
**VERSION:** V2.0  
**REPORT NUMBER:** MM1516  
**STATUS:** FINAL

**SILVER BEAR RESOURCES PLC**

**NI 43-101 TECHNICAL REPORT ON THE MANGAZEISKY SILVER PROJECT MRE UPDATE AND  
STRATEGY RE-ASSESSMENT, REPUBLIC OF SAKHA (YAKUTIA), RUSSIAN FEDERATION**

**November 2021**

**PREPARED BY:**

Ché Osmond  
Alan Clarke  
James Turner  
Sassoun Horsley-Kozadijan  
Philip Burris  
Alison Allen  
Nikolai Shatkov

**APPROVED BY:**

Phil Newall



Wardell Armstrong is the trading name of Wardell Armstrong International Ltd,  
Registered in England No. 3813172.

Registered office: Sir Henry Doulton House, Forge Lane, Etruria, Stoke-on-Trent, ST1 5BD, United Kingdom

UK Offices: Stoke-on-Trent, Birmingham, Bolton, Cardiff, Carlisle, Edinburgh, Glasgow, Leeds, London, Manchester,  
Newcastle upon Tyne and Truro. International Offices: Almaty and Moscow.

ENERGY AND CLIMATE CHANGE  
ENVIRONMENT AND SUSTAINABILITY  
INFRASTRUCTURE AND UTILITIES  
LAND AND PROPERTY  
MINING AND MINERAL PROCESSING  
MINERAL ESTATES  
WASTE RESOURCE MANAGEMENT

## CONTENTS

<b>1</b>	<b>SUMMARY</b> .....	<b>1</b>
1.1	Introduction .....	1
1.2	Vertikalny - Mineral Resource Estimate .....	1
1.3	Mangazeisky North – Mineral Resource Estimate .....	3
1.4	Hydrological & Hydrogeological Review .....	4
1.5	Geotechnical Review.....	5
1.6	NSR Model.....	5
1.7	Open Pit Mining .....	5
1.8	Underground Mining.....	6
1.9	Mine Production Schedule & Equipment Requirements.....	7
1.10	Capital and Operating Costs – Mining .....	7
1.11	Mineral Processing.....	8
1.12	Capital and Operating Costs – Processing.....	9
1.13	Financial Analysis .....	9
<b>2</b>	<b>INTRODUCTION</b> .....	<b>11</b>
2.1	Terms of Reference and Reporting Aims .....	11
2.2	Qualifications of Consultants .....	12
<b>3</b>	<b>RELIANCE ON OTHER EXPERTS</b> .....	<b>15</b>
3.1	Sources of Information and Extent of Reliance .....	15
3.2	Effective Date .....	15
3.3	Terms and Units of Measurement .....	16
<b>4</b>	<b>PROPERTY DESCRIPTION AND LOCATION</b> .....	<b>17</b>
4.1	Property Description and Location .....	17
4.2	Licence Tenure .....	17
4.3	Royalties, Agreements and Encumbrances.....	19
4.4	Environmental Liabilities and Permitting.....	19
<b>5</b>	<b>ACCESSIBILITY, LOCAL RESOURCES, INFRASTRUCTURE AND PHYSIOGRAPHY</b> .....	<b>20</b>
5.1	Physiography.....	20
5.2	Operating Season .....	20
5.3	Sufficiency of Surface Rights .....	20
5.4	Accessibility.....	21
5.5	Infrastructure .....	21
<b>6</b>	<b>HISTORY AND PREVIOUS WORK</b> .....	<b>23</b>
<b>7</b>	<b>GEOLOGY AND MINERALISATION</b> .....	<b>24</b>
<b>8</b>	<b>DEPOSIT TYPE</b> .....	<b>26</b>
<b>9</b>	<b>EXPLORATION</b> .....	<b>28</b>
<b>10</b>	<b>DRILLING</b> .....	<b>29</b>
<b>11</b>	<b>SAMPLE PREPARATION, ANALYSIS AND SECURITY (ITEM 11)</b> .....	<b>30</b>
11.1	Introduction .....	30
11.2	Methodology.....	30
11.3	Security .....	30

11.4	Sample Preparation .....	31
11.5	Quality Control Procedures.....	31
11.6	Quality Control Analysis - Vertikalny .....	32
11.7	Quality Control Analysis – Mangazeisky North.....	58
<b>12</b>	<b>DATA VERIFICATION.....</b>	<b>77</b>
12.1	Procedures .....	77
12.2	Location, Spacing, Distribution and Orientation of Data .....	77
12.3	Personal Inspection.....	78
12.4	Limitations.....	78
12.5	Opinion on Data Adequacy .....	78
<b>13</b>	<b>MINERAL PROCESSING AND METALLURGICAL TESTWORK.....</b>	<b>79</b>
13.1	Procedures .....	79
13.2	Historical Testwork .....	79
13.3	Limitations.....	83
13.4	Opinion on Data Adequacy .....	83
<b>14</b>	<b>MINERAL RESOURCE ESTIMATION .....</b>	<b>84</b>
14.1	Mineral Resource Estimation - Vertikalny .....	84
14.2	Mineral Resources Estimate – Mangazeisky North .....	123
<b>15</b>	<b>MINERAL RESERVE ESTIMATE .....</b>	<b>150</b>
<b>16</b>	<b>MINING METHODS.....</b>	<b>151</b>
16.1	Mining Methods.....	151
16.2	Hydrology and Hydrogeology .....	151
16.3	Geotech.....	159
16.4	Net Smelter Return Model.....	169
16.5	Mineable Tonnes.....	172
16.6	Open Pit Optimisation.....	174
16.7	Open Pit Design.....	178
16.8	Underground Mining.....	184
16.9	Mine Production Scheduling and Equipment Requirements.....	191
16.10	Risks .....	200
<b>17</b>	<b>RECOVERY METHODS.....</b>	<b>203</b>
17.1	Introduction .....	203
17.2	Process Design .....	203
17.3	Operating Performance .....	209
17.4	Ore Sorting .....	210
17.5	Conclusions .....	213
<b>18</b>	<b>INFRASTRUCTURE .....</b>	<b>216</b>
18.1	Introduction .....	216
18.2	Logistical Infrastructure .....	216
18.3	Site Layout and Construction .....	218
18.4	Site Roads.....	220
18.5	Processing Facility .....	220
18.6	ROM Pad and Crushing .....	221
18.7	The Mill .....	221

18.8	Power Supply and Distribution .....	222
18.9	Tailings .....	222
18.10	Waste Rock Dump, Ore Stockpile and Overburden Storage Area .....	223
18.11	Site Water Management.....	225
18.12	Waste and Sewage.....	226
18.13	Site Facilities.....	226
18.14	Site Security .....	229
18.15	Remote Site Facilities.....	229
<b>19</b>	<b>MARKET STUDIES AND CONTRACTS.....</b>	<b>230</b>
19.1	Product Realisation .....	230
19.2	Commodity Market Outlook .....	231
<b>20</b>	<b>ENVIRONMENTAL STUDIES, SOCIAL IMPACT AND PERMITTING .....</b>	<b>232</b>
20.1	Existing Environmental Conditions .....	232
20.2	Existing Socio-Economic Conditions .....	237
20.3	Stakeholder Agreement .....	239
20.4	Environmental and Social Impact Assessment, Mitigation and Management Plans.....	240
20.5	Water and Waste Management .....	244
20.6	ERM Comments .....	246
20.7	WAI Evaluation.....	248
<b>21</b>	<b>CAPITAL AND OPERATING COST DEVELOPMENT .....</b>	<b>249</b>
21.1	Mining - Introduction.....	249
21.2	Open Pit Costs.....	249
21.3	Underground Costs .....	251
21.4	Processing Costs.....	253
<b>22</b>	<b>FINANCIAL ANALYSIS.....</b>	<b>254</b>
22.1	Overview .....	254
22.2	Metal Prices .....	254
22.3	Macroeconomic Parameters.....	255
22.4	Payment & Realisation Terms.....	255
22.5	Processing Recovery Rates and Production Summary.....	256
22.6	Capital Costs.....	256
22.7	Operating Costs.....	256
22.8	Tax Regime .....	256
22.9	Financial Summary .....	257
22.10	Sensitivity Analysis .....	258
<b>23</b>	<b>ADJACENT PROPERTIES .....</b>	<b>260</b>
<b>24</b>	<b>OTHER RELEVANT DATA AND INFORMATION.....</b>	<b>261</b>
24.1	Risks and Opportunities .....	261
<b>25</b>	<b>CONCLUSIONS &amp; RECOMMENDATIONS .....</b>	<b>269</b>
25.1	Vertikalny - Mineral Resource Estimate .....	269
25.2	Mangazeisky North – Mineral Resource Estimate .....	269
25.3	Hydrological & Hydrogeological Review .....	269
25.4	Geotechnical Review.....	270
25.5	NSR Model.....	270

25.6	Open Pit Mining .....	271
25.7	Underground Mining.....	272
25.8	Mine Production Scheduling & Equipment Requirements.....	272
25.9	Capital and Operating Costs – Mining .....	273
25.10	Processing .....	274
25.11	Financial Analysis .....	274
<b>26</b>	<b>REFERENCES .....</b>	<b>276</b>
<b>27</b>	<b>CERTIFICATES OF QUALIFIED PERSONS.....</b>	<b>277</b>

## TABLES

Table 1.1:	Mineral Resource Estimate. Vertikalny Project, Russia. 31 <sup>st</sup> May 2019 .....	2
Table 1.2:	Mineral Resource Estimate. Vertikalny Project, Russia. 31 <sup>st</sup> May 2019 .....	3
Table 1.3:	Mineral Resource Estimate. Mangazeisky North Project, Russia. 31 <sup>st</sup> of May 2019 .....	4
Table 1.4:	Vertikalny Conceptual Pit Design Physicals (Dilution & Recovery Applied).....	6
Table 1.5:	Vertikalny Conceptual Underground Design Physicals (Dilution & Recovery Applied) .....	7
Table 1.6:	Project Processing Opex Summary .....	9
Table 1.7:	Financial Project Summary.....	10
Table 2.1:	Summary of QP's .....	13
Table 4.1:	Mining License Coordinates .....	18
Table 4.2:	Exploration License Coordinates.....	18
Table 4.3:	Licence Details.....	19
Table 9.1:	Historic Exploration Activities at the Property (after Tetra Tech, 2017) .....	28
Table 11.1:	Example Results for Blank Samples at Vertikalny .....	34
Table 11.2:	List of Certified Reference Materials .....	37
Table 11.3:	Summary of CRMs Data for Vertikalny .....	38
Table 11.4:	Risk Matrix Vertikalny QA/QC Review .....	58
Table 11.5:	Summary Table of Control Samples.....	58
Table 11.6:	List of Certified Reference Materials .....	61
Table 11.7:	Summary of CRMs Data for North Mangazeyskiy.....	62
Table 11.8:	Risk Matrix Vertikalny QA/QC Review .....	76
Table 13.1:	Summary of Locked Cycle Flotation Testwork on Primary Ore .....	81
Table 13.2:	Analysis of Pb and Zn Concentrates .....	82
Table 14.1:	Exploration Database Files.....	85
Table 14.2:	Grade Control Database Files.....	85
Table 14.3:	Assays Performed by BH Type and Periods.....	86
Table 14.4:	Final Database .....	89
Table 14.5:	Sample Data Contained in Individual Wireframe Zones .....	95
Table 14.6:	Statistical Analysis of Selected Samples.....	96
Table 14.7:	Statistical Analysis of Composites for Various Types of Workings.....	98
Table 14.8:	Statistical Analysis of Composites for Various Types of Workings within the Open Pit ....	98
Table 14.9:	Top Cut Levels .....	99
Table 14.10:	Statistical Analysis of Composites .....	102

Table 14.11: Parameters of Modelled Variograms .....	104
Table 14.12: Block Model Prototype .....	105
Table 14.13: Density Data for Samples taken in 2004-2012.....	107
Table 14.14: Vertikalny Grade Estimation Plan .....	109
Table 14.15: Comparison of Composite and Block Model Average Grades .....	113
Table 14.16: Block Model vs Grade Control Data from October 2018 to July 2019 – Vertikalny.....	115
Table 14.17: Optimisation Parameters for Constraining Open Pit Mineral Resources .....	118
Table 14.18: Parameters used to Constrain Underground Mineral Resources.....	119
Table 14.19: Data for NSR Calculation .....	119
Table 14.20: NSR COG for Open Pit and Underground Mining .....	120
Table 14.21: Mineral Resource Estimate. Vertikalny Project, Russia. 31st May 2019 .....	122
Table 14.22: Mineral Resource Estimate. Vertikalny Project, Russia. 31st May 2019 .....	122
Table 14.23: OREALL MRE (2019) vs WAI MRE (2019).....	123
Table 14.24: Information in Exploration Database Files.....	125
Table 14.25: Summary of Database .....	125
Table 14.26: Distribution of Samples between Exploration Types.....	127
Table 14.27: Statistical Data for Individual Wireframe Zone.....	130
Table 14.28: General Statistics for Composites Inside Wireframe .....	130
Table 14.29: Statistical Parameters for Composites within Individual Zones.....	131
Table 14.30: Statistics of Composites separately for Drill Holes and Trenches.....	132
Table 14.31: Quantile Analysis of Silver Grades for Individual Zones.....	133
Table 14.32: Parameters of Modelled Variograms for Silver, Zone 1.....	138
Table 14.33: Block Model Prototype .....	139
Table 14.34: Data to Determine Density .....	141
Table 14.35: Plan of Grade Interpolation .....	142
Table 14.36: Search Ellipsoid .....	142
Table 14.37: Global Comparison of Ag Grades in Block Model, Samples, and Composites for Individual Mineralized Zones within Wireframes.....	143
Table 14.38: Mineral Resource Estimate. Mangazeisky North Project, Russia. 31 <sup>st</sup> of May 2019 .....	148
Table 14.39: Mineral Resource Estimation, Tetra Tech, 2017 .....	149
Table 16.1: Finite Element Stability Analysis Results.....	164
Table 16.2: Pit Design Parameters.....	165
Table 16.3: Q Parameters (Derived from footwall Q' values).....	167
Table 16.4: Pit Design Parameters.....	169
Table 16.5: Vertikalny Open Pit .....	172
Table 16.6: Vertikalny Underground Material .....	173
Table 16.7: Mangazeisky North Open Pit.....	173
Table 16.8: Optimisation Input Parameters.....	175
Table 16.9: Vertikalny In-situ Pit Shell Physicals.....	176
Table 16.10: Optimisation Input Parameters.....	177
Table 16.11: Mangazeisky North In-situ Pit Shell Physicals .....	178
Table 16.12: Vertikalny Open Pit Design Parameters.....	178
Table 16.13: Vertikalny Conceptual Pit Design Physicals (Dilution & Recovery Applied).....	181
Table 16.14: Mangazeisky North Open Pit Design Parameters .....	181

Table 16.15: Mangazeisky Conceptual Pit Design Physicals (Dilution & Recovery Applied) .....	184
Table 16.16: NSR Cut-Off Parameters.....	185
Table 16.17: Stope Optimisation Parameters.....	185
Table 16.18: Vertikalny In-situ Stope Tonnages & Grade .....	185
Table 16.19: Vertikalny UG Resource Class Proportions .....	186
Table 16.20: Underground Design Parameters .....	188
Table 16.21: Development Dimensions .....	188
Table 16.22: Vertikalny Conceptual Underground Design Physicals (Dilution & Recovery Applied) .	191
Table 16.23: Vertikalny Open Pit Physicals.....	193
Table 16.24: Mangazeisky North Open Pit Physicals .....	194
Table 16.25: Vertikalny UG Physicals.....	195
Table 16.26: Stockpile Balance (Closing Balance).....	195
Table 16.27: Ore Feed (Through Sorter from Q2 2020).....	196
Table 16.28: Process Plant Feed .....	197
Table 16.29: Underground Development Schedule .....	198
Table 16.30: Estimated Equipment Requirements .....	199
Table 16.31: Existing Mining Equipment on Site .....	199
Table 16.32: Underground Equipment Requirements.....	200
Table 19.1: Commodity Price Assumptions .....	231
Table 20.1: Summary of Terrestrial Ecosystem Communities .....	234
Table 20.2: Key Project Stakeholder Groups .....	240
Table 20.3: Key Environmental and Socio-Economic Aspects .....	241
Table 21.1: Summary of Leasing Payments for main OP mining equipment (D&B, L&H).....	250
Table 21.2: Access Route Development Cost .....	250
Table 21.3: Open Pit Operating Costs by Centre .....	251
Table 21.4: Underground Development Costs .....	251
Table 21.5: Capital Expenditure Summary.....	252
Table 21.6: Pre-Production Underground Equipment Capital Expenditure (2021).....	252
Table 21.7: Underground Operating Cost Summary .....	253
Table 21.8: Project Processing Opex Summary .....	253
Table 22.1: Commodity Price Assumptions .....	254
Table 22.2: Macroeconomic Assumptions.....	255
Table 22.3: Project Payment Terms.....	255
Table 22.4: Summary of the Project Processing Recovery and Metals Production.....	256
Table 22.5: Project Capital Costs Summary (US\$M, nominal total for the LOM).....	256
Table 22.6: Less Operating Costs (US\$M, nominal values).....	256
Table 22.7: Project Tax Summary .....	257
Table 22.8: Key Project Technical and Economic Indicators.....	257
Table 22.9: Financial Project Summary.....	258
Table 22.10: Project NPV (8%) Sensitivity Analysis Results .....	259
Table 24.1: Legend for SWOT Analysis.....	261
Table 24.2: SWOT Analysis for the Vertikalny and North Mangazeisky Projects .....	261



## FIGURES

Figure 4.1: Property Location Map (after Tetra Tech, 2017) .....	17
Figure 7.1: Regional Geology of the Property (after Tetra Tech, 2017).....	24
Figure 8.1: Mineralized Zones on the Property (after Tetra Tech, 2017) .....	26
Figure 11.1: Blank Samples analysed for Ag using ME-ICP62 method.....	33
Figure 11.2: Blank Samples analysed for Ag using ME-OG62 method.....	33
Figure 11.3: Blank Samples analysed for Ag using ME-GRA22 method.....	34
Figure 11.4: Blank Samples Analysed for Pb on Vertikalny .....	36
Figure 11.5: Blank Samples Analysed for Zn on Vertikalny.....	36
Figure 11.6: GBM 303-1, Ag, CRM Assaying Results .....	39
Figure 11.7: GBM 303-1, Pb, CRM Assaying Results .....	39
Figure 11.8: GBM 303-1, Zn, CRM Assaying Results .....	40
Figure 11.9: GBM 310-16, Ag, CRM Assaying Results .....	40
Figure 11.10: GBM 310-16, Pb, CRM Assaying Results .....	41
Figure 11.11: GBM 310-16, Zn, CRM Assaying Results .....	41
Figure 11.12: GBM 906-6, Ag, CRM Assaying Results .....	42
Figure 11.13: GBM 906-6, Pb, CRM Assaying Results .....	42
Figure 11.14: GBM 906-6, Zn, CRM Assaying Results .....	43
Figure 11.15: GBM 909-11, Ag, CRM Assaying Results .....	43
Figure 11.16: GBM 909-11, Pb, CRM Assaying Results .....	44
Figure 11.17: GBM 909-11, Zn, CRM Assaying Results .....	44
Figure 11.18: GBM 909-13, Ag, CRM Assaying Results .....	45
Figure 11.19: GBM 909-13, Pb, CRM Assaying Results .....	45
Figure 11.20: GBM 909-13, Zn, CRM Assaying Results .....	46
Figure 11.21: GBM 913-13, Ag, CRM Assaying Results .....	46
Figure 11.22: GBM 997-4, Ag, CRM Assaying Results .....	47
Figure 11.23: GBM 997-4, Pb, CRM Assaying Results .....	47
Figure 11.24: GBM 997-4, Zn, CRM Assaying Results .....	48
Figure 11.25: GBM 998-9, Ag, CRM Assaying Results .....	48
Figure 11.26: SOP-01-2016, Ag, CRM Assaying Results .....	49
Figure 11.27: SOP-01-2016, Pb, CRM Assaying Results .....	49
Figure 11.28: SOP-01-2016, Zn, CRM Assaying Results .....	50
Figure 11.29: SOP-02-2016, Ag, CRM Assaying Results .....	50
Figure 11.30: SOP-02-2016, Pb, CRM Assaying Results .....	51
Figure 11.31: SOP-02-2016, Zn, CRM Assaying Results .....	51
Figure 11.32: SOP-03-2016, Ag, CRM Assaying Results .....	52
Figure 11.33: SOP-03-2016, Pb, CRM Assaying Results .....	52
Figure 11.34: MST SG 130i, Ag, CRM Assaying Results .....	53
Figure 11.35: MST SG 151h, Ag, CRM Assaying Results.....	53
Figure 11.36: HARD Plot for Field Duplicates, Ag .....	54
Figure 11.37: Field Duplicates Correlation Plot, Ag .....	55
Figure 11.38: HARD Plot for Field Duplicates, Pb.....	55

Figure 11.39: HARD Plot for Field Duplicates, Zn.....	56
Figure 11.40: Correlation Plot for Field Duplicates, Pb.....	56
Figure 11.41: Correlation Plot for Field Duplicates, Zn.....	57
Figure 11.42: Blank Samples Analysed for Ag on North Mangazeisky.....	59
Figure 11.43: Blank Samples Analysed for Pb on North Mangazeyskiy.....	60
Figure 11.44: Blank Samples Analysed for Zn on North Mangazeyskiy.....	60
Figure 11.45: GBM 310-16, Ag, CRM Assaying Results.....	63
Figure 11.46: GBM 310-16, Pb, CRM Assaying Results.....	63
Figure 11.47: GBM 310-16, Zn, CRM Assaying Results.....	64
Figure 11.48: GBM 906-6, Ag, CRM Assaying Results.....	64
Figure 11.49: GBM 906-6, Pb, CRM Assaying Results.....	65
Figure 11.50: GBM 906-6, Zn, CRM Assaying Results.....	65
Figure 11.51: GBM 909-11, Ag, CRM Assaying Results.....	66
Figure 11.52: GBM 909-13, Ag, CRM Assaying Results.....	66
Figure 11.53: GBM 909-13, Pb, CRM Assaying Results.....	67
Figure 11.54: GBM 909-13, Zn, CRM Assaying Results.....	67
Figure 11.55: GBM 913-13, Ag, CRM Assaying Results.....	68
Figure 11.56: SOP-01-2016, Ag, CRM Assaying Results.....	68
Figure 11.57: SOP-01-2016, Pb, CRM Assaying Results.....	69
Figure 11.58: SOP-01-2016, Zn, CRM Assaying Results.....	69
Figure 11.59: SOP-02-2016, Ag, CRM Assaying Results.....	70
Figure 11.60: SOP-02-2016, Pb, CRM Assaying Results.....	70
Figure 11.61: SOP-02-2016, Zn, CRM Assaying Results.....	71
Figure 11.62: SOP-03-2016, Ag, CRM Assaying Results.....	71
Figure 11.63: HARD Plot for Field Duplicates, Ag.....	72
Figure 11.64: Primary vs Half Core Field Duplicates Correlation Plot, Ag.....	73
Figure 11.65: HARD Plot for Field Duplicates, Pb.....	74
Figure 11.66: HARD Plot for Field Duplicates, Zn.....	74
Figure 11.67: Correlation Plot for Field Duplicates, Pb.....	75
Figure 11.68: Correlation Plot for Field Duplicates, Zn.....	75
Figure 14.1: Location of Drillholes (blue) and Trenches (red) at Vertikalny.....	87
Figure 14.2: Location of Open Pit at Vertikalny Central Area as of May 2019.....	88
Figure 14.3: Log Probability Plot of Ag grades for Sample Data.....	90
Figure 14.4: Plan View Showing Location of Mineralised Zones.....	91
Figure 14.5: Isometric View of Mineralised Zones.....	91
Figure 14.6: Isometric View of Central Area Only Showing Mineralised Zones.....	92
Figure 14.7: Modelled Zones of Oxidation at Vertikalny.....	93
Figure 14.8: Log Probability Plots Comparing Grades for Oxide and Primary Mineralisation for a) Ag, b) Pb and c) Zn.....	94
Figure 14.9: a) Histogram of Lengths of Selected Samples, b) Histogram of Composite Lengths.....	97
Figure 14.10: Log Probability Plots Showing Top Cut Levels for Ag for Zone 1 - a) Oxide, b) Primary100	
Figure 14.11: Log Probability Plots Showing Top Cut Levels for Ag for Zone 2 - a) Oxide, b) Primary100	
Figure 14.12: Log Probability Plots Showing Top Cut Levels for Ag for: a) Zone 3 - Primary, b) Zone 6 - Oxide.....	101

Figure 14.13: Ag Modelled Variogram, Zone 2, Along Strike.....	103
Figure 14.14: Ag Modelled Variogram, Zone 2, Down-Dip .....	104
Figure 14.15: Block Model of Mineralisation - Green: oxide, Blue: primary .....	106
Figure 14.16: Wireframe Model of Zone 1 with Points Used to Determine Dynamic Anisotropy .....	107
Figure 14.17: Example Cross-Section Comparing Drillhole and Block Model Ag Grades .....	110
Figure 14.18: Example SWATH Analysis for Zone 2 - Primary Mineralisation .....	111
Figure 14.19: Location of the High Grade Silver Composites (>1000g/t) for Primary mineralisation, Zone 1 .....	114
Figure 14.20: Unconstrained Block Model Classification.....	118
Figure 14.21: Mineral Resources for Open Pit Mining.....	120
Figure 14.22: Mineral Resources for Underground Mining.....	121
Figure 14.23: Locations of drill hole collars and trenches completed at the exploration phase. Trenches as shown in grey and the drill holes are shown according to the legend.....	126
Figure 14.24: Mineralized Zone Wireframe Models for Mangazeisky North. Some zones are below Zone 1 .....	128
Figure 14.25: Section crossing the Mineralized Wireframes. Highlighted areas with abrupt changes in the mineralized occurrence in the near holes .....	129
Figure 14.26: Trench Location with High Grade of Silver, Zone 17.....	134
Figure 14.27: Statistical Plots for Silver, Zone 1.....	135
Figure 14.28: Statistical Plots for Silver, Zone 4.....	135
Figure 14.29: Statistical Plots for Silver, Zone 17.....	136
Figure 14.30: Ag Modelled Variogram, Zone 1, Along the Strike .....	137
Figure 14.31: Ag Modelled Variogram, Zone 1, Down-Dip .....	137
Figure 14.32: Ag Modelled Variogram, Zone 1, Across the Strike .....	138
Figure 14.33: Block Model of Mangazeisky North Mineralization Relative to Surface .....	139
Figure 14.34: Wireframe Model of Zone 1 with Points Used to Determine Dynamic Anisotropy .....	140
Figure 14.35: Block Model Grades vs Original Samples.....	144
Figure 14.36: SWATH Plot for Ag, looking from South to North.....	145
Figure 14.37: Mineral Resources for Open Pit Mining.....	147
Figure 14.38: Wireframe Models of TT (red) and WAI (blue) with workings at Mangazeisky North .....	149
Figure 16.1: Approximate Mine Layout Sand Topographic Relationship (ERM, 2014).....	152
Figure 16.2: Project Surface Water Systems (photos and flow records courtesy of Nerungristroyresearch, Vol. 3 Book 1 (Hydrometeorology), April 2016) .....	155
Figure 16.3: Underground Mine Layout (Tetra Tech, 2017) .....	158
Figure 16.4: Vertikalny Rock Mass Composition.....	161
Figure 16.5: Vertikalny Geotechnical Domain Cross-Section (SRK Geotechnical Study) .....	162
Figure 16.6: Regional Geological Map .....	163
Figure 16.7: Finite Element Modelling Slope Geometry .....	164
Figure 16.8: Stability Graph for Proposed Open Stop Dimensions .....	166
Figure 16.9: Q Support Chart (UG Development).....	168
Figure 16.10: Mangazeisky North Rock Mass Cross-Section .....	169
Figure 16.11: Vertikalny Cut & Fill Road .....	179
Figure 16.12: Vertikalny Conceptual Pit Design.....	180
Figure 16.13: Vertikalny Conceptual Pit Design -Sectional View .....	180

Figure 16.14: Mangazeisky Cut & Fill Road.....	182
Figure 16.15: Mangazeisky North Conceptual Pit Design .....	183
Figure 16.16: Mangazeisky North Conceptual Pit Design – Section View .....	183
Figure 16.17: Planned Underground Mining Zones.....	186
Figure 16.18: Vertikalny Stopes .....	187
Figure 16.19: Vertikalny Conceptual Underground Mine Design – Sectional View.....	189
Figure 16.20: Vertikalny Underground Zone 1-3 Isometric View .....	190
Figure 16.21: Vertikalny Underground Zone 4 Isometric View .....	190
Figure 17.1: Schematic Flowsheet for Oxide Ore .....	205
Figure 17.2: Schematic Process Flowsheet for Primary Sulphide Ore .....	208
Figure 17.3: Final Silver Recovery .....	209
Figure 17.4: Mining Schedule.....	211
Figure 18.1: Regional Transport Routes (Tetra Tech 2017) .....	217
Figure 18.2: Site Infrastructure Layout (Tetra Tech 2017).....	218
Figure 18.3: Process Plant Facility Layout (Tetra Tech 2017) .....	219
Figure 18.4: Process Plant Layout (Tetra Tech 2017).....	221
Figure 20.1: Surface Water Quality Compared to MPC for Water Courses for Fishery Water Bodies (MPCf) [Tetra Tech 2017].....	236
Figure 20.2: SPNAs in the Surroundings of the Project Area (Tetra Tech 2017).....	237
Figure 22.1: Project NPV (8.64%) Sensitivity Analysis Results .....	259

## APPENDICES

APPENDIX 1: VERTIKALNY - QUANTILE ANALYSIS

APPENDIX 2: VERTIKALNY – JORC TABLE 1

APPENDIX 3: MANGAZEISKY NORTH – JORC TABLE 1

APPENDIX 4: FINANCIAL MODEL

## **1 SUMMARY**

### **1.1 Introduction**

Silver Bear Resources PLC (“SBR”) has commissioned Wardell Armstrong International (“WAI”) to carry out an update of its mineral resource base and strategic re-assessment of the Mangazeisky Silver Project. The study aimed to assess the combined potential of the Vertikalny and Mangazeisky North deposits and identify any strategic bottlenecks. The key elements included within the study are listed below:

- Mineral Resource Estimation;
- Hydrological and hydrogeological review;
- Mining geotechnical review;
- Open pit mining study;
- Underground mining study;
- Mine production scheduling;
- Mining capital and operating cost estimation;
- Mineral processing review; and
- Financial analysis.

### **1.2 Vertikalny - Mineral Resource Estimate**

The Mineral Resource Estimate was carried out with a 3D block modelling approach using Datamine Studio RM software. The effective date of the Mineral Resource Estimate is the 31<sup>st</sup> May 2019, the date of the limiting mine survey. In the opinion of WAI, the Mineral Resource Estimate reported herein is a reasonable representation of the mineral resources found in the Vertikalny Silver Project based on the current level of sampling.

WAI has been provided with exploration and grade control data for Vertikalny comprising all exploration carried out from 2005 to 2018 by CJSC Prognoz. Exploration data were imported and verified before geological and mineralisation envelopes were defined creating 3D wireframes based on a cut-off grade of 50g/t Ag representing the various mineralised zones at Vertikalny. In addition, digital terrain model (DTM) surfaces, surveys of mined-out areas, surfaces of overlapping sediments and boundaries of oxide and primary mineralisation were imported and/or created. Sample data were selected using the geological and mineralisation wireframes and selected samples were assessed for outliers before being composited to a length of 1.0m as the basis for geostatistical study.

The wireframe envelopes were used as the basis for a volumetric block model with a parent cell size of 10m x 10m x 10m and appropriate sub-celling to meet wireframe boundaries. Dynamic anisotropy was used to estimate dip and dip directions into each block of the model to control search ellipse orientation during grade estimation. Block model validation was carried out using visual, statistical and graphical checks between input composite sample data and estimated block grades.

Variogram models were constructed based on composite data and used Ordinary Kriging (OK) as the principal estimation methodology. Inverse Power Distance Cubed (IPD<sup>2</sup>) was used for validation purposes.

The resultant estimated grades were validated against the input composite data and classification in accordance with the guidelines of the JORC Code (2012) and was carried out based on an assessment of geological and grade continuity and an assessment of assay data quality. Key drillhole spacing for the allocation of Mineral Resources stipulated Measured resources at 40m spacing, Indicated resources at 80m, and Inferred resources within greater than 80m. Mineral Resources (Table 1.1) were further limited based on an expectation of eventual economic extraction to an optimised open pit shell generated using appropriate economic and technical parameters. Underground Mineral Resources (Table 1.2) were allocated below the base of the optimised pit shell and above the Net Smelter Return cut-off value of \$162.0/t.

<b>Table 1.1: Mineral Resource Estimate. Vertikalny Project, Russia. 31<sup>st</sup> May 2019 (In Accordance with the Guidelines of the JORC Code (2012)) Potential Open Pit Resources</b>								
<b>Ag Cut-off, g/t</b>	<b>Category</b>	<b>Tonnes, Kt</b>	<b>Ag, g/t</b>	<b>Pb, %</b>	<b>Zn, %</b>	<b>Ag, kg</b>	<b>Pb, t</b>	<b>Zn, t</b>
<b>200</b>	<b>Oxide</b>							
	Measured	94.90	949.88	2.01	1.58	90,141	1,909	1,500
	Indicated	89.24	1,181.88	1.33	1.92	105,469	1,190	1,710
	<b>Sub-Total M+I</b>	<b>184.14</b>	<b>1,062.32</b>	<b>1.68</b>	<b>1.74</b>	<b>195,610</b>	<b>3,099</b>	<b>3,211</b>
	<b>Primary</b>							
	Measured	13.19	1,328.95	1.85	1.96	17,524	244	258
	Indicated	36.14	1,830.08	2.28	1.42	66,148	825	514
	<b>Sub-Total M+I</b>	<b>49.33</b>	<b>1,696.13</b>	<b>2.17</b>	<b>1.56</b>	<b>83,672</b>	<b>1,069</b>	<b>772</b>
	<b>Oxide + Primary</b>							
	<b>Total M+I</b>	<b>233.47</b>	<b>1,196.24</b>	<b>1.79</b>	<b>1.71</b>	<b>279,282</b>	<b>4,168</b>	<b>3,983</b>

**Notes:**

1. Mineral Resources are reported in accordance with the guidelines of the JORC Code (2012).
2. Mineral Resources are not Ore Reserves until they have demonstrated economic viability based on a feasibility study or pre-feasibility study.
3. Mineral resources include all potential mineable tonnage.
4. Mineral Resources are estimated as of 31 May 2019 based on an open pit mine survey of the same date.
5. Mineral Resources were constrained by an optimised pit shell using a NSR cut-off value of \$172.78/t for oxide and \$139.06/t for primary mineralisation.
6. Mineral Resources were constrained by an optimised pit shell based on economic and mining parameters provided by the Client and/or accepted by WAI.
7. This mineral resource estimate is not limited to any factors in terms of environmental, permitting, legal, title, taxation, socio-economic, market and other relevant factors.
8. The metal resources include all the in-situ metal disregard the metallurgical recovery factor.
9. All values in the tables have been rounded with relative accuracy of estimate.
10. Numbers may not compute due to rounding.

**Table 1.2: Mineral Resource Estimate. Vertikalny Project, Russia. 31st May 2019  
 (In Accordance with the Guidelines of the JORC Code (2012)) Potential Underground Resources**

Ag Cut-off, g/t	Category	Tonnes, Kt	Ag, g/t	Pb, %	Zn, %	Ag, kg	Pb, t	Zn, t
<b>300</b>	Measured	0.29	581.70	2.66	0.58	166	8	2
	Indicated	235.82	680.72	1.26	2.57	160,524	2,964	6,059
	<b>M+I</b>	<b>236.10</b>	<b>680.60</b>	<b>1.26</b>	<b>2.57</b>	<b>160,690</b>	<b>2,972</b>	<b>6,061</b>
	Inferred	109.42	538.93	1.26	1.75	58,970	1,378	1,919

**Notes:**

1. Mineral Resources are reported in accordance with the guidelines of the JORC Code (2012).
2. Mineral Resources are not Ore Reserves until they have demonstrated economic viability based on a feasibility study or pre-feasibility study.
3. Mineral resources include all potential mineable tonnage.
4. Mineral Resources are estimated as of 31 May 2019 based on an open pit mine survey of the same date.
5. Mineral Resources are located below an optimised pit and were evaluated based on an NSR cut-off value of \$162.00/t for primary mineralisation.
6. Economic and mining parameters provided by the Client and/or accepted by WAI were incorporated in the calculation of NSR.
7. This mineral resource estimate is not limited to any factors in terms of environmental, permitting, legal, title, taxation, socio-economic, market and other relevant factors.
8. The metal resources include all the in-situ metal disregard the metallurgical recovery factor.
9. All values in the tables have been rounded with relative accuracy of estimate.
10. Numbers may not compute due to rounding.

### 1.3 Mangazeisky North – Mineral Resource Estimate

The Mineral Resource Estimate was carried out with a 3D block modelling approach using Datamine Studio RM software. The effective date of the Mineral Resource Estimate is the 31st of May 2019. In the opinion of WAI, the Mineral Resource Estimate reported herein is a reasonable representation of the mineral resources found in the Mangazeisky North Silver Project based on the current level of sampling.

WAI has been provided with exploration data for Mangazeisky North comprising all exploration carried out since 2013 to 2016 by CJSC Prognoz. Exploration data were imported and verified before geological and mineralisation envelopes were defined creating 3D wireframes based on a cut-off grade of 50g/t Ag representing the various mineralised zones at Mangazeisky North. In addition, digital terrain model (DTM) surfaces and surfaces of overlapping sediments were imported and/or created. Sample data were selected using the geological and mineralisation wireframes and selected samples were assessed for outliers before being composited to a length of 1.0m as the basis for geostatistical study.

The wireframe envelopes were used as the basis for a volumetric block model with a parent cell size of 10m x 10m x 10m and appropriate sub-celling to meet wireframe boundaries. Dynamic anisotropy was used to estimate dip and dip directions into each block of the model to control search ellipse orientation during grade estimation. Block model validation was carried out using visual, statistical and graphical checks between input composite sample data and estimated block grades.

Variogram models were constructed based on composite data and used Ordinary Kriging (OK) as the principal estimation methodology. Inverse Power Distance Cubed (IPD2) was used for validation purposes. The resultant estimated grades were validated against the input composite data and classification in accordance with the guidelines of the JORC Code (2012) was carried out based on an

assessment of geological and grade continuity and an assessment of assay data quality. Due to absence of data for definition oxide/primary boundary only Inferred Mineral Resources were classified at Mangazeisky North. Mineral Resources (Table 1.3) were further limited based on an expectation of eventual economic extraction to an optimised open pit shell generated using appropriate economic and technical parameters.

<b>Table 1.3: Mineral Resource Estimate. Mangazeisky North Project, Russia. 31<sup>st</sup> of May 2019 (In Accordance with the Guidelines of the JORC Code (2012)) Potential Open Pit Resources</b>								
<b>Ag Cut-off, g/t</b>	<b>Category</b>	<b>Tonnes, Kt</b>	<b>Ag, g/t</b>	<b>Pb, %</b>	<b>Zn, %</b>	<b>Ag, kg</b>	<b>Pb, t</b>	<b>Zn, t</b>
200	Inferred	331.41	750.15	9.71	0.98	248,612	32,185	3,261

**Notes:**

1. Mineral Resources are reported in accordance with the guidelines of the JORC Code (2012).
2. Mineral Resources are not Ore Reserves until they have demonstrated economic viability based on a feasibility study or pre-feasibility study.
3. Mineral resources include all potential mineable tonnage.
4. Mineral Resources are estimated as of 31 May 2019.
5. Mineral Resources were constrained by conceptual optimum pit contours using NSR of \$139.06/t for primary mineralisation.
6. All values in the tables have been rounded with relative accuracy of estimate. Numbers may not compute due to rounding.
7. Mineral Resources were constrained by an optimum pit shell based on the corresponding economic and mining parameters provided by the Client and/or accepted by WAI
8. This mineral resource estimate is not limited to any factors in terms of environmental, permitting, legal, title, taxation, socio-economic, market and other relevant factors.
9. The metal resources include all the in-situ metal disregard the metallurgical recovery factor.

#### 1.4 Hydrological & Hydrogeological Review

The Mangazeisky open pit, located in an interfluvial area between creeks, is likely to encounter frozen groundwater and receive negligible groundwater inflow. Dewatering and drainage within the pit, using sump and perimeter collectors should be designed for a peak event representing a combined spring thaw and design storm event i.e., 1 in 100 year.

The southern end of the Vertikalny deposit is located on the flanks of the Porfirovy stream valley and this zone represents a different hydrogeological domain from the interfluvial areas with much higher groundwater circulation and recharge from surface to depth. This means permafrost is likely to be thinner. Given the 300m depth of underground workings in Vertikalny Zone 1 in particular (south, river flank) and to a lesser extent in Zone 4 (interfluvial) it is likely that free-flowing groundwater will be encountered in mid to lower levels of the underground mine. Across most of the underground sections (Zones 2 and 3), it is expected there will be negligible groundwater inflow because of permafrost.

Hydrogeological drilling is required to confirm permafrost conditions in Zones 1 and 4 and form the basis for an inflow model and dewatering plan. The hydrogeological wells should be tested to confirm hydraulic properties in sections using double packers so that isolated zones within and beneath the expected permafrost zones can be characterised. Wells should be drilled and tested throughout the full thickness of the proposed mine i.e. 300m.



Water supply for the mine, via a proposed water supply borehole near borehole GS15-05, should be tested by conducting a long-term pumping test i.e., 28 days and recovery phase to determine the storage and yield characteristics if this is to be used as supply well.

Surface water hydrology and the mine water balance have been reviewed and no particular additional comments over and above what has already been presented by SRK are raised.

## 1.5 Geotechnical Review

WAI has carried out a review of the geotechnical information provided by SBR for the Vertikalny and Mangazeisky North deposits. The review has aimed to summarise the geotechnical parameters for use in mine optimisation and design. Information was drawn from the findings of the geotechnical study carried out by SRK consulting in late 2014. WAI has not carried out an independent review of the geotechnical data used in the SRK study.

## 1.6 NSR Model

A basic Net Smelter Return (NSR) calculation was performed which considered grade, metal price, metallurgical recovery, and metal payability. The payable metal includes the applicable concentrate and refining charges but does not include price participation or penalty element payments. The metal price assumptions were derived by WAI and approved by SBR. All metallurgical recoveries/costs used in the NSR calculation are based on data provided by SBR.

NSR factors were calculated and directly applied to each block within the Resource block models. This enabled the subsequent mine optimisation exercises to be carried out on the block NSR values. The NSR model forms a critical input into the development of the mining study and further detail regarding the NSR inputs must be understood to enhance the confidence of the study.

## 1.7 Open Pit Mining

WAI has carried out an open pit mining study to define a mineable tonnage estimate for the Vertikalny and Mangazeisky North deposits.

Open pit optimisation was carried out using the Datamine NPV Scheduler v4 (NPVS) software package. Pit optimisations were carried out on the Resource block models generated for the two deposits and driven on the calculated block NSR values. The optimisations included *Measured*, *Indicated* and *Inferred* resources.

Detailed mine designs were generated from the selected optimal shells using the Datamine Studio OP V2.4 general mine planning package. The designs were used to derive the mineable tonnage estimates and formed the basis for subsequent production scheduling.

A summary of the tonnages and grades contained within the Vertikalny and Mangazeisky North pit designs is provided in Table 1.4.

Parameter	Units	Vertikalny	Mangazeisky North
<b>Oxide Material</b>	kt	212	-
<i>Ag Grade</i>	<i>g/t</i>	800	-
<b>Sulphide Material</b>	kt	116	347
<i>Ag Grade</i>	<i>g/t</i>	846	570
<i>Pb Grade</i>	%	1.70	7.47
<i>Zn Grade</i>	%	1.66	0.82
<b>Total Mineralised Tonnes</b>	kt	329	347
<b>Oxide Material (Below Cut-Off)</b>	kt	45.0	--
<b>Sulphide Material (Below Cut-Off)</b>	kt	29.0	72.2
<b>Waste</b>	kt	11,000	8,540
<b>Strip</b>	tw:to	33.7	24.8
<b>Average NSR</b>	US\$/t <sub>ore</sub>	382	245

**Note:**

- Mining Dilution of 30% and Mining Loss of 5% applied to **all** mineralised material.
- All figures rounded to 3SF, Pb/Zn grades rounded to 2DP
- Oxide material processed through oxide circuit; Pb/Zn are not recovered and are not reported.
- Strip ratio not inclusive of below cut-off material.
- Waste tonnes not inclusive of below cut-off material.
- Figures effective as of 01.06.19

It should be noted that ‘minable tonnage estimates’ are not Ore Reserves and are not demonstrative of technical and economic viability.

## 1.8 Underground Mining

WAI has carried out a mining study to define an underground mineable tonnage estimate for the Vertikalny deposit. The study has considered the volume of mineralised material below the generated Vertikalny pit designs.

Underground mineable tonnage estimates were prepared using the Vertikalny Resource block model. Stope optimisation was completed using the Mineable Shape Optimiser (MSO) module in the Datamine Studio 5D Planner software package. The optimisations included *Measured*, *Indicated* and *Inferred* resources.

A summary of the tonnages and grades contained within the conceptual underground mine designs is provided in Table 1.5.

Parameter	Units	Value
<b>Stope Mineralised Material</b>	kt	609
<i>Ag Grade</i>	<i>g/t</i>	462
<i>Pb Grade</i>	%	2.16
<i>Zn Grade</i>	%	1.68
<b>Development Mineralised Material</b>	kt	232
<i>Ag Grade</i>	<i>g/t</i>	263
<i>Pb Grade</i>	%	1.37
<i>Zn Grade</i>	%	1.26

**Note:**

- Unplanned Dilution of 10% and Mining Loss of 10% applied to **stope** mineralised material.
- Development mineralised tonnes depleted from stope tonnes.
- All figures rounded to 3SF. Pb/Zn grades rounded to 2DP
- Figures not representative of Ore Reserves (in accordance with JORC 2012)

## 1.9 Mine Production Schedule & Equipment Requirements

A combined open pit and underground production schedule was generated using the Geovia MineSched V9.2 mine scheduling software package. Effort was made to sequence the operations such that a steady flow of plant feed is maintained over the life-of-mine. Key points noted from the generated production schedule include:

- Overall mine life anticipated at 8 years;
- Mining in the Vertikalny open pit anticipated for completion in Q4 2021;
- Mining at Mangazeisky North anticipated to commence in Q3 2021 with production ceasing in Q3 2023; and,
- Underground pre-production development anticipated to start in Q2 2022 with stope production commencing in Q4 2023.

Open pit and underground mining equipment requirements were estimated on first principles analysis to achieve the generated production schedule. No ventilation studies were carried out for the underground mining operations and it is recommended that such studies be considered in more detailed engineering studies utilising the latest underground resource model.

## 1.10 Capital and Operating Costs – Mining

A mining cost model was developed to assess the open pit and underground mining capital and operating expenditures for the Mangazeisky Project. The cost estimates were developed by WAI based on data provided by SBR and WAI's internal cost database.

A summary of the costs is presented below:

Open Pit Capital Costs:	<b>US\$2.53M</b>
Open Pit Operating Costs:	<b>US\$2.17 /t<sub>MINED</sub></b>
Underground Capital Costs:	<b>US\$23.33M</b>
Underground Operating Cost:	<b>US\$40.56/t<sub>ORE</sub></b>

Total mining operating cost resulted in US\$82.3M (or US\$49.5/t ore mined) and capital cost of US\$25.86M for both open pit and underground mining operations.

### 1.11 Mineral Processing

Silver production commenced in April 2018 and silver recovery has steadily improved from approximately 55-60% in 2018 to an average of 70.5% for the nine months to September 2019, although this is still somewhat off the design recovery for oxide ore of 85%. Silver was previously lost due to poor washing of the tailings filter cake, which has now reportedly been resolved. There is also an ongoing impact on recovery and costs due to primary/transition ore being included in the oxide feed as oxide resources are depleted. Due to SBR concerns with the original direct electrowinning process (high zinc and chloride levels in the feed solution), a Merrill Crowe circuit was constructed in April 2019 which can reportedly operate in parallel with the electrowinning circuit or in series to treat the electrowinning tails solution.

Current process plant throughput is slightly below the design of 110,000tpa (approximately 96,000tpa pro-rata from the September YTD number of 71,769t). The actual May 2019 YTD process operating cost reviewed was \$74.9/t, significantly higher than the design of \$47.9/t. This is mostly due to the impact of transition/sulphide ore in the feed blend with higher reagent consumptions, low activity lime and an incorrect design lime consumption of only 0.7kg/t used in the original feasibility study, compared to the testwork data of 20-30kg/t.

For the proposed processing of primary sulphide ore, a new flotation circuit is required for production of separate lead and zinc concentrates, with cyanide leaching of the lead flotation middlings as per the current plant. The annual throughput through the new flotation plant will also be increased to 180,000tpa. The capital cost for a brand-new plant of approximately \$17.3M is considered reasonable, although this reduces to approximately \$9M if the existing oxide circuit is used and the additional equipment retro-fitted (such as the flotation plant and additional crushing and grinding capacity for the higher throughput). The new plant is scheduled to be commissioned in June 2021 and, until then, the sulphide ore will be processed through the current plant with impact on recovery and costs.

The recoveries used in the optimisation and conceptual design studies are based on the ESTAGeo testwork results, with silver, lead and zinc recoveries of 85.4%, 65.9% and 82.2% respectively. Based on these results, the zinc concentrate at 42.4% Zn is considered to be saleable based on typical western smelter contracts. The lead concentrate at only 17.1% Pb is very low grade, but high in silver value at 10,215g/t Ag, according to the testwork results. This is therefore assumed to be most likely saleable to an Asian smelter.

The NSR terms for both concentrates have been provided by SBR for use in the pit optimisation studies (84% and 45% respectively for the lead and zinc concentrates).

The process operating cost for primary ore using the new flotation circuit has been estimated by SBR as US\$46.3/t and is considered reasonable for use in the pit optimisation studies. This compares with the Tetra Tech design operating cost of US\$121.8/t based on using the existing oxide plant (no flotation circuit), but with modifications for finer grinding, higher cyanide levels and additional leach residence time.

SBR has conducted ore sorter testwork on samples of oxide ore from current production. Based on these results, the current schedule assumes that approximately 270ktpa of ore will be mined with 180,000ktpa reporting to the flotation plant after crushing and ore sorting with 99% recovery of Ag, Pb and Zn to the flotation feed. This applies to both oxide and sulphide ore. The ore sorter is scheduled to be commissioned in April 2020.

### 1.12 Capital and Operating Costs – Processing

Total processing operating cost is estimated as US\$68.3M. A summary of processing operating costs is shown in Table 1.6 below.

<b>Table 1.6: Project Processing Opex Summary</b>		
Ore Sorting Cost	US\$ /t	2.25
<b>Leach Plant (Current Plant)</b>		
Unit Processing Cost (Oxides)	US\$ /t	72.95
Unit Processing Cost (Sulphides)	US\$ /t	123.71
<b>Flotation Plant (New Plant)</b>		
Unit Processing Cost (Sulphides)	US\$ /t	47.18

Processing capital costs for construction of the new flotation plant have been estimated at US\$17.3M. However, as most of required equipment is currently installed on the existing plant, the outstanding amount of capital costs has been estimated at approximately US\$9.2M. In addition, US\$2M has been allocated for the XRT sorter section.

### 1.13 Financial Analysis

Preliminary Economic Assessment of the Mangazeisky project has resulted in a positive NPV at various discount rates. The Project is mostly sensitive to changes in Silver prices. Break-even price of the Project has been estimated at US\$14.11/oz, which is 21% lower than the base case silver price assumption.

Base case NPV @8.64% was estimated at US\$46.51M (nominal values).

The financial analysis has been performed to reflect valuation as of the end of 2019 and does not include any sunk costs that have been previously invested in the project.

Overall capital cost of the project has been estimated at US\$43M, and total operating costs of US\$242.7M. The key project performance is shown in Table 1.7 below.

<b>Table 1.7: Financial Project Summary</b>		
NPV @ Discount Rate of 8.64%	US\$ M	46.51
Ag Break-even price	US\$/oz	14.11
<b>NPV @ Discount Rate of 10%</b>	<b>US\$ M</b>	<b>43.87</b>
NPV @ Discount Rate of 15%	US\$ M	35.77
NPV @ Discount Rate of 20%	US\$ M	29.60
<b>IRR</b>	<b>%</b>	<b>N/A</b>
Payback period of capital (Discounted, Cumulative)	date	Q3 2021

*Current financial results have been derived from the production schedule that considers oxide material from stockpile No 5 to the amount of approximately 50kt.*

## 2 INTRODUCTION

### 2.1 Terms of Reference and Reporting Aims

Silver Bear Resources plc (SBR) is listed on the Toronto Stock Exchange (TSX:SBR) and is the 100% owner of the 570km<sup>2</sup> Mangazeisky exploration licence (EL) containing the Vertikalny silver mine concession in the Republic of Sakha (Yakutia). SBR was granted a 20-year Mining Licence for the Vertikalny deposit in September 2013 with first silver production on stream after commissioning in April 2018 stepping up to commercial production in July 2019. The current processing facility is set to be upgraded including new sorting facilities installed by June 2020. The Mangazeisky EL is valid until 2023.

This report was prepared as a National Instrument 43-101 (NI 43-101) Technical Report for Silver Bear Resources plc by Wardell Armstrong International (Russia) Ltd. (WAI). The quality of information, conclusions, and estimates contained herein is consistent with the level of effort involved in WAI's services, based on: i) information available at the time of preparation, ii) data supplied by outside sources, and iii) the assumptions, conditions, and qualifications set forth in this report. This report is intended for use by SBR subject to the terms and conditions of its contract with WAI and relevant securities legislation. The contract permits SBR to file this report as a Technical Report with Canadian securities regulatory authorities pursuant to NI 43-101, Standards of Disclosure for Mineral Projects. Except for the purposes legislated under provincial securities law, any other uses of this report by any third party is at that party's sole risk. The responsibility for this disclosure remains with SBR. The user of this document should ensure that this is the most recent Technical Report for the property as it is not valid if a new Technical Report has been issued.

The aims of this report are to:

- Provide an updated mineral resource estimate and a classification of resources in accordance with the Canadian Institute of Mining, Metallurgy and Petroleum Standards on Mineral Resources and Reserves: Definitions and Guidelines, May, 2019 (CIM);
- Based on the updated resource estimate provide a Scoping Study level integrated mine design and schedule for the Vertikalny and North Mangazeisky open pits including transition to future Vertikalny underground production;
- Tailor the mine design and schedule to the increased production rates expected through upgrade to the sulphide process facility and installation of a new ore sorting system;
- Assess risks and opportunities arising from the plan for development.

In accordance with Article 7.1(1) (b) of Form 43-101F1 (2011) given that the Client has its properties as the subject of this report in a foreign jurisdiction, WAI has elected to report mineral resources according to the Australasian Code for Reporting of Exploration Results, Mineral Resources and Ore Reserves [JORC Code (2012)].

Supporting information has been sourced from company reports generated by Tetra Tech, Hatch, ESTAGEO, Irgiredmet and from WAI's own archive. These documents are referenced in Section 26.

WAI also received historical information from maps, longitudinal and cross sections, data tables and documents prepared by SBR for statutory reporting (TEOs, 5G Reports, etc.). Documents used in the preparation of this report are assumed by the authors as accurate and complete in all aspects.

WAI has reviewed assay and geological results from SBR diamond drilling, trenching and reverse circulation drill campaigns conducted between 2009 and 2019. Assay and geological results represent:

- **Vertikalny:** A total of 304 diamond holes drilled for a running total of 44,060m and 210 grade control trenches. Maximum hole depth was 496m;
- **North Mangazeisky:** A total of 157 diamond holes drilled and 50 exploration trenches. Maximum hole depth was 122m.

The Consultants used their experience to determine if the information from previous reports was suitable for inclusion in this technical report and adjusted information that required amending. This report includes technical information, which required subsequent calculations to derive subtotals, totals and weighted averages. Such calculations inherently involve a degree of rounding and consequently introduce a margin of error. Where these occur, the Consultants do not consider them to be material.

## **2.2 Qualifications of Consultants**

The Consultants preparing this technical report are specialists in the fields of geology, exploration, mineral resource and mineral reserve estimation and classification, underground mining, geotechnical, environmental, permitting, metallurgical testing, mineral processing, processing design, capital and operating cost estimation, and mineral economics.

None of the Consultants or any associates employed in the preparation of this report has any beneficial interest in SBR. The Consultants are not insiders, associates, or affiliates of SBR. The results of this Technical Report are not dependent upon any prior agreements concerning the conclusions to be reached, nor are there any undisclosed understandings concerning any future business dealings between SBR and the Consultants. The Consultants are being paid a fee for their work in accordance with normal professional consulting practice.

The following individuals, by virtue of their education, experience and professional association, are considered Qualified Persons (QP) as defined in the NI 43-101 standard, for this report, and is a member in good standing of appropriate professional institutions. QP certificates of authors are provided in Section 27. The QPs are responsible for specific sections as summarised in Table 2.1



<b>Table 2.1: Summary of QP's</b>			
<b>No.</b>	<b>Report Section</b>	<b>Company</b>	<b>QP</b>
1	Summary		Sign-off by Section
2	Introduction	WAI	Ché Osmond BSc (Hons), MSc, CGeol, EurGeol, FGS
3	Reliance on other Experts	WAI	Ché Osmond BSc (Hons), MSc, CGeol, EurGeol, FGS
4	Property Description and Location	WAI	Ché Osmond BSc (Hons), MSc, CGeol, EurGeol, FGS
5	Accessibility, Climate, Local Resources, Infrastructure and Physiography	WAI	Ché Osmond BSc (Hons), MSc, CGeol, EurGeol, FGS
6	History	WAI	Ché Osmond BSc (Hons), MSc, CGeol, EurGeol, FGS
7	Geological Setting and Mineralization	WAI	Ché Osmond BSc (Hons), MSc, CGeol, EurGeol, FGS
8	Deposit Type	WAI	Ché Osmond BSc (Hons), MSc, CGeol, EurGeol, FGS
9	Exploration	WAI	Ché Osmond BSc (Hons), MSc, CGeol, EurGeol, FGS
10	Drilling	WAI	Ché Osmond BSc (Hons), MSc, CGeol, EurGeol, FGS
11	Sample Preparation, Analysis and Security	WAI	Ché Osmond BSc (Hons), MSc, CGeol, EurGeol, FGS
12	Data Verification	WAI	Ché Osmond BSc (Hons), MSc, CGeol, EurGeol, FGS
12.3	Personal Inspection	RJC Group	Nikolai Shatkov PhD, MAIG
13	Mineral Processing and Metallurgical Testwork	WAI	James Turner BSc (Hons), MSc, MIMMM, CEng
14	Mineral Resource Estimates	WAI	Alan Clarke BSc (Hons), MSc, CGeol, EurGeol, FGS
15	Mineral Reserve Estimates		n/a
16	Mining Methods	WAI	Sassoun Horsley-Kozadijan BEng, MSc, CEng, MIMMM
16.2	Hydrology & Hydrogeology	WAI	Philip Burris BSc (Hons), MSc., CGeol, FGS
17	Recovery Methods	WAI	James Turner BSc (Hons), MSc, MIMMM, CEng
18	Infrastructure	WAI	Ché Osmond BSc (Hons), MSc, CGeol, EurGeol, FGS
19	Market Studies and Contracts	WAI	Ché Osmond BSc (Hons), MSc, CGeol, EurGeol, FGS
20	Environmental Studies, Permitting and Social or Community Impact	WAI	Alison Allen BSc, MSc, CEnv, FIMMM, MIEMA, MIEEM
21	Capital and Operating Costs		Sign-off by Section
22	Economic Analysis	WAI	Ché Osmond BSc (Hons), MSc, CGeol, EurGeol, FGS
23	Adjacent Properties	WAI	Ché Osmond BSc (Hons), MSc, CGeol, EurGeol, FGS
24	Other Relevant Data and Information		Sign-off by Section
25	Conclusions and Recommendations		Sign-off by Section
26	References		Sign-off by Section

### **2.2.1 Details of Personal Inspection**

Nikolai Shatkov, PhD in Geology, MAIG, conducted a site visit to the Property on 30<sup>th</sup> October 2021.

At the time of the site visit, the QP inspected the current open pit operations, processing plant, inspection of current drilling operations, a visit to the core shed (core cutting and sample preparation), logging facilities, on-site laboratory, sample duplicate/reject storage facilities, and discussions with senior and key geological/technical staff to verify the data collection, sample preparation, and data/sample management procedures.

Nikolai Shatkov was accompanied, and guided, on the site visit by the following personnel:

- Sergey Kraushkin, Chief Geologist for CJSC Prognoz;
- Vladimir Stepanov, Exploration Geologist for CJSC Prognoz;
- Alexey Chumakov, Chief Engineer for CJSC Prognoz;
- Smirnova Nikolaevna, Head of the Laboratory CJSC Prognoz, and
- Peshkov Nikolaevich, deputy head of the concentrating plant CJSC Prognoz.

### **3 RELIANCE ON OTHER EXPERTS**

The Consultant's opinion contained herein is based on information provided to the Consultants by SBR Corporate in Moscow and Management at Vertikalny Minesite throughout the course of the investigations. WAI has relied upon the work of other consultants in the project areas in support of this Technical Report. The sources of information include data and reports supplied by SBR personnel as well as documents referenced in Section 26.

Historic information provided to WAI and used to prepare this report was acquired by SBR from a variety of sources that have had access to geologic, metallurgical, environmental and engineering studies and from predecessor companies. The predecessor company includes JSC Yanageologia.

#### **3.1 Sources of Information and Extent of Reliance**

##### **3.1.1 Land Tenure**

WAI has not conducted any legal due diligence with regard to land tenure and ownership but has relied on documents and communications provided by SBR as issued by the Department of Subsoil Use for the Republic of Sakha in its technical review of land ownership and mineral tenure.

Mineral title due diligence, Russian legal and regulatory compliance, and nature and extent of underlying agreements was not conducted by WAI. The authors rely on legal information provided by SBR and its subsidiaries, as well as documentation from the Russian Federal and Regional authorities presented in this report.

##### **3.1.2 Marketing and Financial Analysis Reliance**

Mr. Ché Osmond has relied on Mrs Veronika Luneva, Dip Economist, IMC Member, for Marketing and Financial Analysis information provided in Sections 19 and 22 respectively. Mrs. Luneva has over 10 years' experience and successfully completed a wide variety of in-depth financial evaluations for both open pit and underground operations involved in various projects ranging from preliminary economic assessment to pre-feasibility/feasibility studies for hard rock minerals, as well as technical-economic audits, with particular experience of the Russian and CIS mining markets.

#### **3.2 Effective Date**

The effective date for issue of this report is 10<sup>th</sup> November 2021. The effective date for the Mineral Resource Estimates for Vertikalny and Mangazeisky North is 31<sup>st</sup> May 2019. The effective date for reliance of information contained in this report is 28<sup>th</sup> May 2020 as no data or material information used in its compilation was considered after this date.

### 3.3 Terms and Units of Measurement

All units of measurement used in this report are reported in the *Système Internationale d'Unités* (SI), as utilised by the Canadian and international mining industries, including: metric tons (tonnes, t), million metric tonnes (Mt), kilograms (kg) and grams (g) for weight; kilometres (km), metres (m), centimetres (cm) or millimetres (mm) for distance; cubic metres (m<sup>3</sup>), litres (l), millilitres (ml) or cubic centimetres (cm<sup>3</sup>) for volume, acres, square kilometres (km<sup>2</sup>) or hectares (ha) for area, and tonnes per cubic metre (t/m<sup>3</sup>) for density. Elevations are given in metres above sea level (masl).

Geochemical results or precious metal grades may be expressed in parts per million (ppm), parts per billion (ppb), or g/t. (Note: 1 ppm = 1 g/t). Precious metal quantities may also be reported in troy ounces (ounces, oz), a common practice in the mining industry. Base metal grades are usually expressed in weight percent (%).

The following conversions are used in the preparation of this report:

- 1 gram = 0.03215 troy ounce
- 1 kilogram = 32.1507 troy ounces
- 1 tonne = 32,150.7 troy ounces

All currency amounts are stated in US dollars (US\$ or \$) or Russian Rubles (₽) unless otherwise specified. The units of measure presented in this report are metric units except for bullion prices which are quoted in troy ounces (toz). Silver values are reported in grams per tonne (g/t) or parts per million (ppm), respectively. Gold is also reported in grams per tonne (g/t). Tonnage is reported as metric tonnes (t), unless otherwise specified.

Mangazeisky is also referred in the literature as 'Mangazeyskiy' or Endybal.

## 4 PROPERTY DESCRIPTION AND LOCATION

Information from this section is drawn from Tetra Tech (2017) and reliant thereupon the accuracy of this information.

### 4.1 Property Description and Location

The Property is located in the north of Kobayasky District, in central Sakha Republic (Yakutia), and is comprised of one mining licence within a larger exploration licence, the centroid of which at approximately 65°40' south and 130°07' east. It lies approximately 400 km north of Yakutsk, capital city of the Sakha Republic, 300 km southwest of Batagai and approximately 230 km north of Sangary, a river port on the right bank of the Lena River (Figure 4.1)



Figure 4.1: Property Location Map (after Tetra Tech, 2017)

### 4.2 Licence Tenure

SBR holds the mineral rights to the Property through its 100% interest in ZAO Prognoz. SBR purchased ZAO Prognoz in 2004 from the National Resource Company. The mining license, number YaKU 03626 BE, covers the entire Vertikalny silver deposit over an area of 13.55 km<sup>2</sup>. The coordinates of the mining license are shown in Table 4.1 as well as the surrounding Exploration License (Table 4.2).

<b>Table 4.1: Mining License Coordinates</b>		
<b>Mining Licence YaKU 03626 BE</b>		
<b>Corner no</b>	<b>Northing Coordinate</b>	<b>Easting Coordinate</b>
1	65°41'15.917"	130°01'55.381"
2	65°41'41.938"	130°03'23.150"
3	65°41'37.066"	130°04'59.859"
4	65°41'20.210"	130°06'27.196"
5	65°40'08.102"	130°08'20.361"
6	65°39'44.803"	130°08'11.742"
7	65°39'40.272"	130°07'17.802"
8	65°36'46.221"	130°05'22.190"
9	65°39'54.675"	130°03'29.389"
10	65°40'11.350"	130°01'57.673"
11	65°40'46.388"	130°01'42.001"

<b>Table 4.2: Exploration License Coordinates</b>		
<b>Mining Licence YaKU 03626 BE</b>		
<b>Corner no</b>	<b>Northing Coordinate</b>	<b>Easting Coordinate</b>
1	65°49'35"	130°00'00"
2	65°49'35"	130°19'20"
3	65°29'00"	130°22'00"
4	65°29'00"	130°00'00"

The exploration licence YaKU 12692 BP was granted to Prognoz on 24th September 2004 by the Federal Subsoil Resources Management Agency (ROSNEDRA) and was valid for an initial term of five years. Three extensions were granted until 31st December 2016. WAI understands that a further seven-year extension was granted until December 2023 with no minimum expenditure commitments.

The exploration licences give the recipient the authority to use the subsoil for the purposes of geological investigation within the licence area, for exploration, and appraisal of the gold and silver deposits. The licence area has the status of a “geological allotment” with the preliminary borders outlined and an unlimited licenced depth for investigation. There are no specially protected natural territories within the limits of the licence.

In September 2013, SBR received its mining licence YaKU 03626 BE for the Vertikalny deposit. The term of the licence is approximately 20 years (to 2033). The licence requirements include:

- Completion of 15,000m of drilling and 15,000m<sup>3</sup> of trenching by or before December 2017;
- Initiation of drilling and trenching no later than March 2015;
- Mine must be operational within the next nine years (2023), inclusive of permitting and report approvals;
- Mine output must be greater than 180,000tpa by the year 2023.

A summary of the terms of the licence agreements is presented in Table 4.3.

**Table 4.3: Licence Details**

Licence Name	Licence ID	Type	Area (km <sup>2</sup> )	Issue Date	Expiry Date	Annual Fees (RUB)
Endybal Area (Mangazeisky)	YaKU 12692 BP	Geological Allotment	570.00	28 September 2004	31 December 2023	150,242
Vertikalny Deposit	YaKU 03626 BE	Licence to Use Subsoil	13.55	31 August 2013	1 September 2033	110,771

### 4.3 Royalties, Agreements and Encumbrances

On 21st October 2004, SBR completed an acquisition of all of the outstanding shares of ZAO Prognoz. Pursuant to the transaction, SBR acquired 100% of the issued and outstanding common shares of Prognoz for RUB10,000,000 or CAD331,000 and assumed certain bank indebtedness and other liabilities of ZAO Prognoz. The parties to the transaction agreed that the value of the exploration licences held by Prognoz closely approximated the indebtedness assumed and accordingly, a value of RUB20,585,221 or CAD890,310 was attributed to the licences.

*WAI is not aware of any liability in the form of royalties, financial encumbrances or any other debts/liabilities relating to other commercial activities carried out on the licence area but these may be applicable.*

### 4.4 Environmental Liabilities and Permitting

WAI is not aware of any existing liabilities arising from previous industrial activity and land use and it is not part of the scope of this study to investigate historical impacts caused by project activities to date.

Baseline studies to fulfil environmental requirements for exploration activities revealed that concentrations of minerals in some surface water and sediment samples did exceed local regulatory standards in some cases, which were attributed to natural weathering processes across the Project affecting regional watersheds and to exploration activities in local waterways near the Vertikalny deposit area. It is assumed that the legacy of such emissions have been addressed where possible during exploration work and incorporated into the Environmental OVOS.

## **5 ACCESSIBILITY, LOCAL RESOURCES, INFRASTRUCTURE AND PHYSIOGRAPHY**

Information from this section is drawn from Tetra Tech (2017) and reliant thereupon the accuracy of this information.

Support for infrastructure development of Vertikalny was potentially available from the Regional Government of Yakutia as part of its “Scheme of Complex Development of Productive Forces, Transport and Power Industry of the Sakha Republic [Yakutia] by 2020”. WAI has not undertaken any investigation into tax breaks or other incentives available or taken up by SBR during development of Vertikalny.

### **5.1 Physiography**

The Property lies in a mountainous region with elevations ranging from 800 to 1,400masl. The main ridges have steep slopes (25 to 30° and rounded crests that are 200 to 500 above the valley floors). The vegetation surrounding the Property is composed of ‘Taiga’ - primarily aspen, birch and fir trees in the lower parts of the valleys.

The climate of northeast Russia is Continental subarctic to Tundra Climate zones (Dfd to ET; Köppen climate classification) and is characterized extreme cold dry winters and cool summer seasons. The nearest weather station to site is located at Verhojansk (National Oceanic and Atmospheric Administration (NOAA) Station ID RA24266; 67°33' North, 133°23' East, 137m). The annual precipitation averages 200 mm with the majority occurring as rain during the summer months. Average temperatures range from +25°C in July to -40°C in December and January. Snow cover is formed around the end of September until mid-May. The area is subject to permafrost to 400m depth with seasonal thaw during the summer of the top 0.5-15m depth.

### **5.2 Operating Season**

Operations and exploration occur all the year round. The exploration field season runs from May to October though drilling is carried out over the winter season when swampy Taiga is frozen.

### **5.3 Sufficiency of Surface Rights**

SBR has industrial surface rights to carry out mining activities and construction on Vertikalny and right of access over Mangazeisky EL. WAI has not conducted an audit as to whether SBR has all the required permissions nor that permits are up to date and not in violation. WAI is also not aware of any third-party commercial rights over the property or any access rights to indigenous populations and activities. WAI has also not carried out any auditing of surface rights or mineral tenure as part of its scope and is not aware of any overlapping licences/resources for precious and base metals, industrial minerals or water resources owned by 3<sup>rd</sup> parties or on the State Reserves Balance. Local artisanal and alluvial operations (“artels”) may be active.



## **5.4 Accessibility**

The Property is only accessible from Yakutsk by air, either by fixed wing aircraft or by helicopter. There is an airstrip on the Property at the confluence of the Endybal and Arkachan Rivers, approximately 10km from the base camp. A flight by AN2 aircraft is typically two hours.

The Property may also be accessed via Batagai, located approximately 300km northeast of the Property. There are regular scheduled flights to Batagai as well as aircraft available for charter.

There is also a winter road for transport of all freight and supplies to the Property.

## **5.5 Infrastructure**

### **5.5.1 Transport**

The Project area is isolated and can be accessed by a winter road that is usable from mid-January until mid-April. Seven tonne all-terrain vehicles (ATVs) are used for transporting workers and materials to site. The main haul route runs north-south 370km to the port of Batamai on the Lena River then on an all-weather road an additional 200km down the Lena Valley to Yakutsk. The Lena River is navigable for barges up to 3,000t to Batamai and Sangar from June to September though there is no road access to the Property from May to December.

Regional airports are located at Sangar and Batagai, located 230km SW and 300km NE of the site respectively. During most of the year the Property is accessible primarily by helicopter or light fixed wing aircraft from Yakutsk, Batagai, or Sangar. Currently, AN-2 and AN-3 fixed wing aircraft are being used for small loads (800 to 900kg); MI-8 MTV and MI-26 helicopters are available for heavier loads (up to 1,800kg).

The Berkakit-Tommot-Yakutsk rail link is reportedly near completion. The rail head will be located on the east side of the River Lena; it is not known if a bridge is planned. This spur will link Yakutsk to the Trans-Siberian, Amur-Yakutia Railroad and the Northern Sea Route. Journey times will be significantly reduced.

### **5.5.2 Power**

There is no access to the main power grid on the Property. Local supply with a capacity of 16MW comes from 12 diesel generating sites. The nearest power generator set to the Project site is at Sebyan-Kuel (375kW). It is planned by 2020 that the electrical generating capacity of Yakutia will be supplemented with a further 8,500MW from seven new power stations. The current status of connecting to this new grid is not known at the time of writing.

### **5.5.3 Water**

Potential water sources include the Arkachan River located 10km from the Project, and the Endybal, Sirelendge, Fedor-Yuryage, and Mangazeisky creeks, which flow through the licence area. WAI understands that water resources have been developed through recent underground exploration and development and that SBR has been working with regulatory authorities (YakutNedra) to put water resources on the State Balance and obtain relevant permitting for extraction for both process and potable water.

### **5.5.4 Labour**

Given the relatively isolated location of the Property use of local resources is limited. There is no pool of local labour and all staff work on a rotational basis from Yakutsk and other parts of Russia. A regional administrative and support office is maintained in Yakutsk. Currently there is a compliment staff working on shift on site and additional staff supporting from Yakutsk. The site compliment of staff is expected to increase to accommodate construction and commissioning staff in 2020.

### **5.5.5 On-Site Infrastructure**

The permanent camp, Hogan Camp, is comprised of one to two room cabins, huts and accommodation containers. There are several permanent structures for kitchen, ablution, warehousing and maintenance, and offices for mine and process administration. There are also buildings for core logging and sampling, sample preparation and sample storage, as well as sheltered core box storage.

## 6 HISTORY AND PREVIOUS WORK

Information from this section before 2016 is drawn from Tetra Tech (2017) and reliant thereupon the accuracy of this information.

The Deposit was initially discovered by Russian Cossacks in 1764. Soviet-era prospecting occurred during 1952 and 1953 and work focused on the Mikhailovsky and Kuzminsky zones, which are located 7.5km and 10km to the north of Vertikalny, respectively. This work included geological mapping (1:50,000), trenching, sampling, and the establishment of two short adits (32m) beneath the trenches. Work also included a topographic survey (1:2,000, 3km<sup>2</sup>) and an induced polarisation (IP) survey (1:5,000, 1.7km<sup>2</sup>). By 1960, the exploration work completed in the licence area had identified more than 160 anomalies within a north-south trend up to 20km in length. This trend is 2km wide in the north (Nuektame River) and up to 4.5 to 5.0km wide in the south (Endybal River).

In 1989, systematic prospecting and exploration resumed. From 1991 to 2003 JSC Yangeologia completed 151,452m<sup>3</sup> of trenching, 10.2-line kms of magnetic surveys, detailed geological mapping, soil geochemical surveys, and 10 diamond drillholes totalling 1,303m. This exploration work covered more than 15 principal vein systems. From 1989 exploration was primarily located within the Vasilievsky, Sterznhevoy, and Nizhne-Endybalsky mineralised zones, outlining over 30 mineralised structures containing potentially economic grades.

After the Russian Financial Crisis of 1998, the early 2000s experienced a rapid rise in foreign investment and the development of silver deposits in Far East Russia at Goltsovoye, Dukat with Pan American Silver, and acquisition of ZAO Prognoz by SBR in 2004. Metallurgical testwork was conducted on two samples and reported by Western Services (2004).

An historical Russian inventory of reserves and resources was compiled in 2000 and reviewed by JSC Yangeologia. NI 43-101 compliant estimates were produced for the Vertikalny structure (Wardrop 2009a) that was later revised in December 2009 (Wardrop 2009b). The Mineral Resource was further updated in the September 2011 PEA (Wardrop 2011) and February 2015 (Tetra Tech 2015a).

In September 2013 SBR was granted a 20-year Mining Licence for the Vertikalny deposit. Construction on Vertikalny commenced in early 2016 and first silver production was achieved on commissioning in April 2018. As of December 31, 2018 a total of 594,921 ounces of silver was produced with sales of 433,095 ounces of silver totalling pre-commercial production revenue of US\$6.4 million.

## 7 GEOLOGY AND MINERALISATION

Information from this section is drawn from Tetra Tech (2017) and reliant thereupon the accuracy of this information.

The Mangazeisky Exploration Licence area is located within the Verkhoyansk mobile belt of north-eastern Yakutia. The fold-and-thrust belt forms part of a major orogenic system separating the Siberian North Asian Craton to the west from the immense expanse of accreted terrains, which form most of the Russian Far East.

The belt extends for 2,000km from the Laptev Sea to the Sea of Okhotsk (Figure 7.1). The belt is made up of a rock package that is greater than seven km in thickness and is comprised of Late Precambrian to Triassic rocks deposited along the paleo-Pacific margin of the Siberian Craton. This margin developed because of rifting events which occurred in the Late Precambrian and again during the Late Devonian to Early Mississippian periods. Deformation events during the Late Jurassic to Early Cretaceous periods were accompanied by low-grade metamorphism in the internal parts of the belt and the emplacement of high-level granitic bodies. During the Tertiary period, strike-slip faulting occurred within the fold-and-thrust belt. The central part of the belt is dominated by a thick monotonous succession of Carboniferous and Permian turbidites which are metamorphosed to lower greenschist grade. Granodiorite and granite plutons intrude the core of the range and are associated with extensive precious metal-bearing quartz vein systems.

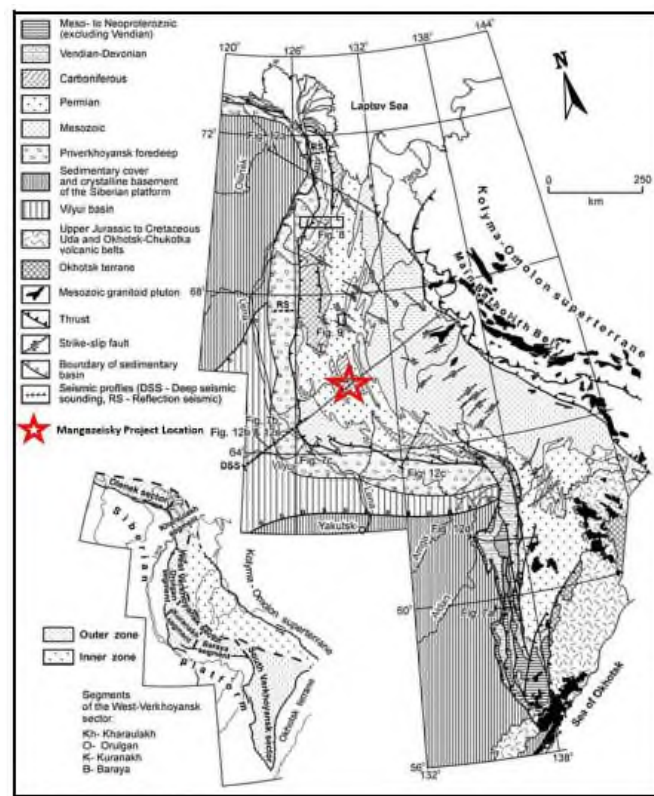


Figure 7.1: Regional Geology of the Property (after Tetra Tech, 2017)

At a district scale lithology and structure are dominated by three events influenced by shearing and overthrusting on the Nuektaminsky-Granichny Fault Zones:

1. Proto-mineralised layers of sandstone containing sulphide mineralisation;
2. Structural deformation
3. Intrusion of the Endybal Diatreme.

## 8 DEPOSIT TYPE

Information from this section is drawn from Tetra Tech (2017) and reliant thereupon the accuracy of this information.

The Property contains several explored areas that host more than 100 occurrences of mineralisation concentrated within a 35km long corridor (Figure 8.1).

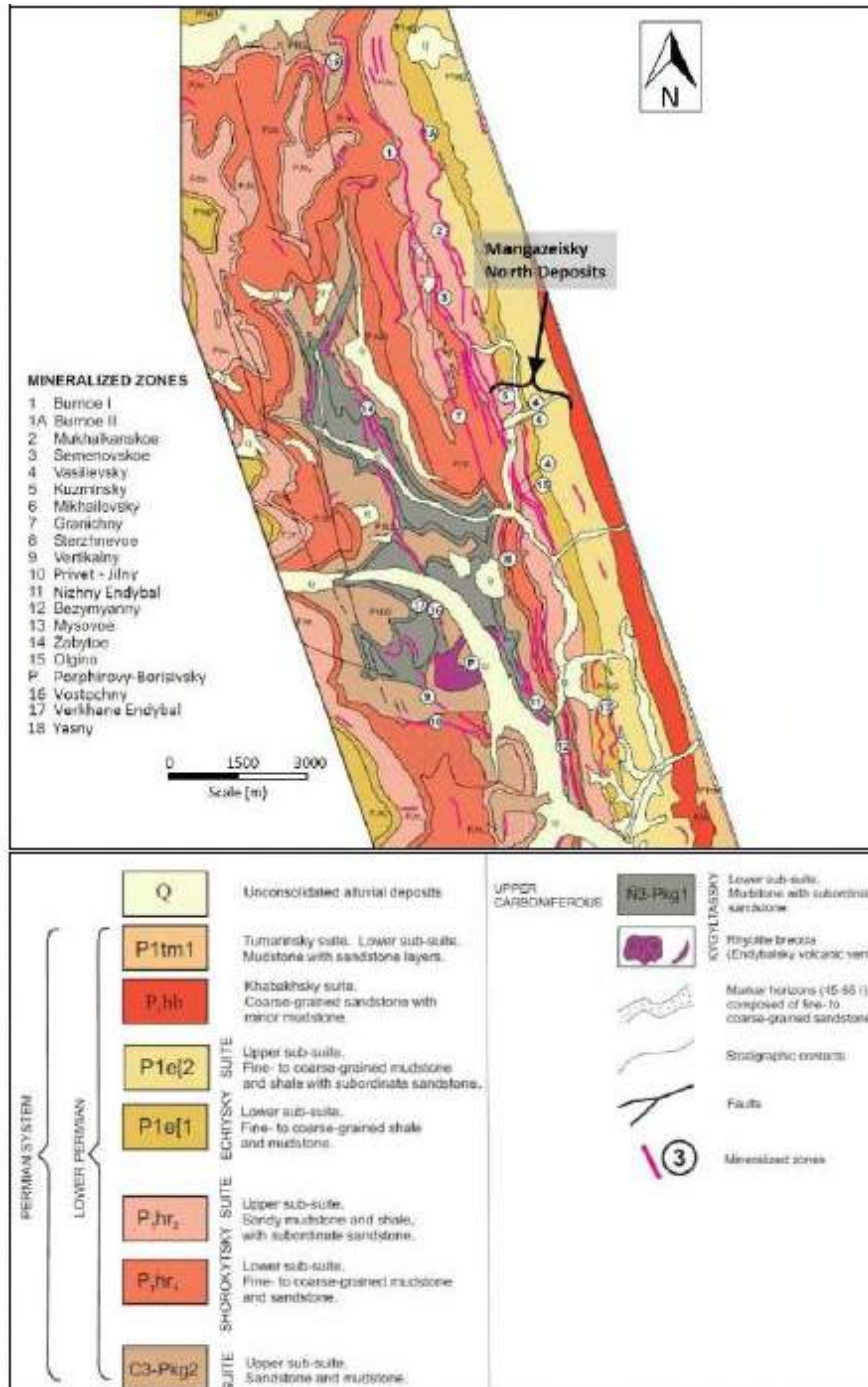


Figure 8.1: Mineralized Zones on the Property (after Tetra Tech, 2017)

Silver mineralization is epigenetic forming in a high-level low-sulphidation environment with meteoric dominated waters fuelled by an underlying porphyry intrusion. The mineralisation on the Property can be broadly classified into four different styles of occurrence:

- Strata-bound silver-bearing, quartz-carbonate-sulphide structures within sandstone with average grades greater than 900g/t silver and lead and zinc by-products. Examples of this are the Vasilievsky—Anglesite-Cerussite and Olgina—Mikhailovsky veins within the Mangazeisky North zone.
- Thick linear-type stockwork areas with carbonate-silver sulphosalt mineralisation. Examples of this occur in the Strezhevoy and Nizhny Endybal Zones.
- Narrow late-stage, steep dipping veins such as Vertikalny that cross-cut stratigraphy and feature grades in excess of 1,000g/t silver over widths ranging from several centimetres to several metres. Vertikalny and possibly Zabytoe and Kis-Kuel are examples of this style of mineralisation.
- A marginal porphyry area associated with quartz, quartz-carbonate and quartz-sulphide veins and veinlets, hosted by extrusive rhyolite porphyry. Porfirovoy is an example of this.

## 9 EXPLORATION

Information from this section is drawn from Tetra Tech (2017) and reliant thereupon the accuracy of this information.

Early exploration by ZAO Prognoz, SBR's subsidiary, was focused upon the narrow, strata-bound silver mineralisation of the Vasilievsky and Mikhailovsky veins at Mangazeisky North. From 2007, the focus shifted to the development of the Vertikalny deposit and included the exploration activities on the thicker, linear, stockworks at Nizhny Endybal. A summary of non-drilling exploration activities is presented in Table 9.1:

<b>Table 9.1: Historic Exploration Activities at the Property (after Tetra Tech, 2017)</b>		
<b>Year</b>	<b>Exploration Activities</b>	<b>Targets Explored</b>
2004	No trench exploration was undertaken during 2004	-
2005	9,641m <sup>3</sup> of trenching	Vasilievsky, Milhailovsky, Sterzhnevoy, Nizhny, Endybal
2006	4,843m <sup>3</sup> of trenching and mapping	Nizhny, Endybal Vostochny, Sterzhnevoy, Vertikalny
2007	8,000m <sup>3</sup> of trenching	Vertikalny
2008	22,633m <sup>3</sup> of trenching. Mapping, lithochemical sampling, direct current induced polarisation/magnetotellurics and magnetic anomaly geophysical surveys.	Vertikalny, Zabyty, Zabyty-2, Kis-Kuel, Orogondia
2009	15,067m <sup>3</sup> of trenching. Lithochemical sampling, magnetic anomaly mapping	Nizhny, Endybal, Vertikalny, Kis-Kuel, Mukhalkan-Burney
2010	No exploration was undertaken in 2010.	-
2011-2012	1,600m <sup>3</sup> of trenching	Nizny, Endybal
2013	52 trenches at regular intervals with 474m of sampling	Mangazeisky North and South
2014	19 trenches across multiple exploration targets	Vertikalny, Mangazeisky South, Porfirovy and Sterzhnevoy
2015	8 trenches for a total length of 593m	Porfirovy and Sterzhnevoy



## 10 DRILLING

Information from this section on programs before 2016 is drawn from Tetra Tech (2017) and reliant thereupon the accuracy of this information.

A total of 304 diamond holes have been drilled and considered for evaluation for a running total of 44,060m. The main drill campaigns at Vertikalny took place in 2005-2015, with no drilling in 2010, and consisted of diamond core drilling only. No Soviet-era drilling was considered for the evaluation.

In the majority of drillholes, the core was oriented at the commencement of every run to allow structural measurements to be made and all holes are subject to down-hole survey at generally 20.0m intervals. Data from HQ (63.5mm) and NQ (47.6mm) wireline diamond drillholes is used for interpretation and grade estimation. The predominate drilling diameter was of HQ size.

A total of 16 metallurgical holes for a running total of 2,786m were drilled either PQ or HQ diameter for technological testwork and ore-type definition in 2017.

A total of 19 advance grade control holes for a running 535m were drilled in 2018.

A total of 233 trenches for a running total of 5,667.87m were sampled for a grade control in 2018-2019. The trenches have 10m spacing on each bench with the bench height of 5m. The grade control samples were collected from 5 benches with elevation from 1,175m through to 1,155m. This campaign was carried out at the Central part of Vertikalny.

WAI is not aware of any specific measures taken to reduce losses through drilling or that any drilling campaign suffered from poor recovery. Diamond drill recovery averages approximately 95% and are considered homogenous and acceptable for evaluation. No apparent relationship has been observed between sample recovery and grade.

## **11 SAMPLE PREPARATION, ANALYSIS AND SECURITY (ITEM 11)**

### **11.1 Introduction**

Prior to 2007 the sample preparation, analyses and security was conducted according to Russian State 'Gostandarts'. Since 2005, sampling has been carried out under SBR's Standard Operational Procedures using a combination of diamond core drillholes and surface trench channel samples.

### **11.2 Methodology**

Diamond drilling was used to obtain predominantly 1.0m samples (minimum length 0.25m to a maximum of 3.00m) that were subsequently cut in half along its long axis, with half core used for primary analysis and the other half retained for reference purposes, to produce half core for sample preparation (crushing/pulverising) and a final sub-sample for laboratory analysis. Trenching was used to obtain predominately 1.0m samples (minimum length 0.10m to a maximum of 2.00m) cut by portable diamond saw and collected using hammer and chisel. The entire sample was taken for sample preparation (crushing/pulverising) to produce a final sub-sample for laboratory analysis.

Grade control (carried out from October 2018 to July 2019) sampling methods were not assessed as part of this study.

WAI understands sampling of dump stockpiles (six stockpiles in total) were taken at random mechanically from each 30t bucket at a temporary weighbridge facility where weight and moisture content were also measured. Four grab samples were taken of approximately 8kg each, representing 1 per mil of the load. Each sample was prepared and assayed according to RF protocol GOST 14180-80 "Ores and concentrates of non-ferrous metals. Methods of sampling and preparation of samples for chemical analysis and determination of moisture".

### **11.3 Security**

Samples were transported to site sample preparation facilities. After preparation in the field, samples were packed into sealed bags and dispatched to the freight forwarders directly by the Company for dispatch direct to the laboratory. The laboratory is obliged to report on discrepancies in the state of the sample when checked in on arrival as part of its LIMS (Laboratory Information Management System) protocol.

## 11.4 Sample Preparation

Sample preparation for Vertikalny was carried out on site. The sample preparation flowsheet comprised:

- Two stage crushing to 85% passing 1mm;
- Split to 1kg sample; and
- Submit for further analysis.

Prior 2011 final milling and pulverising to 85% passing 75µm was carried out in Chemical Laboratory of State Enterprise Aldangeologia in Aldan (Russia) and later in ALS Chemex in Chita, Russia.

WAI is satisfied that sub-sampling quality control has been maintained through use of company SOP's being adopted to ensure consistency by following a standard set of practices throughout the process.

## 11.5 Quality Control Procedures

### 11.5.1 Introduction

Quality assurance and quality control (QA/QC) are the key components to verify the validity of sample collection, security, preparation, and analytical methods. The aim of the QA/QC programme is to quantify and monitor any errors and to provide information that might be used to improve sampling and analytical procedures in order to minimise any errors. A comprehensive QA/QC programme should monitor the accuracy, precision and contamination of each step through exploration from the sampling through the final assay value produced by the laboratory.

QA/QC programmes over the various exploration periods at Vertikalny have incorporated the inclusion of duplicate samples, certified reference materials, and blank samples inserted at differing ratios into the sample stream. The results of WAI analysis are summarised below.

### 11.5.2 WAI Procedures

For duplicate sample sets, the precision can be discussed in terms of the following statistical measures applied by WAI.

- Summary Statistics showing the mean, mode, standard error, range and standard deviation can be indicators if the data sets are in agreement.
- Rank HARD Plot which is the ranked half absolute relative difference, ranks all assay pairs in terms of precision levels measured as half of the absolute relative difference from the mean of the assay pairs (HARD), used to visualise relative precision levels and to determine the percentage of the assay pairs population occurring at a certain precision level (10%). Duplicates on Vertikalny include second core halves and/or repeatedly taken channel samples (so called field duplicates). In this case precision for

70% of samples should be within 10%. It should be noted that as the HARD statistic uses and absolute difference, a ranked HARD plot does not reveal bias in duplicate data, only the relative magnitude of differences (i.e. precision). The HARD values are sorted from lowest to highest and ranked accordingly, with the rank expressed as a percentage. The ranked HARD plot is then generated by plotting the percent rank on the X-axis against the HARD value on the Y-axis. A rank HARD plot is constructed that enables quick identification of the percentage of the sample pairs with a HARD value less than 10%.

- Correlation Plot is a simple plot of the value of the duplicate samples, assay 1 against assay 2. This plot allows an overall visualisation of precision and bias over selected grade ranges. Correlation coefficients are also good indicators to quantify the agreement between data sets. A correlation greater than 0.9 is generally described as strong, whereas a correlation less than 0.6 is generally described as weak.
- Thompson and Howarth Plot showing the mean relative percentage error of grouped assay pairs across the entire grade range, used to visualise precision levels by comparing against given control lines.

For certified reference materials (CRM), control charts such as Shewhart X (average) and R (range) charts are constructed for each element standard. The control charts plot process variability, with metal content on the Y-axis and sample number on the X-axis. The plotting of data on charts of this type allows for the easy recognition of samples that fall outside of the action limits applicable for each standard used. Warning and control limits are established at mean  $\pm 2$  and  $\pm 3$  standard deviation limits respectively. Any analysis beyond the  $\pm 3$  standard deviation limit is considered as a failure.

## 11.6 Quality Control Analysis - Vertikalny

### 11.6.1 Exploration 2009 – 2019

During exploration activities in 2009-2019 (including samples from grade control trenches) blank samples and certified reference materials (CRM) were employed for QA/QC purposes, field duplicates of samples were used for internal control. Project geologists are in charge of insertion of control samples into the samples stream. Field duplicates and blank samples were inserted before crushing, and CRMs were inserted after samples are ground, labelled and registered in a log.

#### 11.6.1.1 Blanks

A local source of siltstone (aleurolite) was used for blank sample material. Blank material was assayed at both the Vertikalny and an external laboratory, before inclusion in the QA/QC programme, to ensure that the material was non mineralised. It was reported that blank samples were inserted at a rate of 1:20 (5%) and a total of 1,061 (Ag) blank samples were available for review.

Blank samples have been analysed for three separate laboratory methods, each with different levels of detection, including ME-ICP62, ME-OG62 and ME-GRA22 methods. The results of the blank analysis for Ag are shown in Figure 11.1, Figure 11.2, and Figure 11.3.

Note that WAI used low detection limits of 0.5ppm (0.00005%) for ME-ICP62, 1.0ppm (0.0001 %) for ME-OG62, and 5ppm (0.0005 %) for ME-GRA22, as per ALS analysis methods.

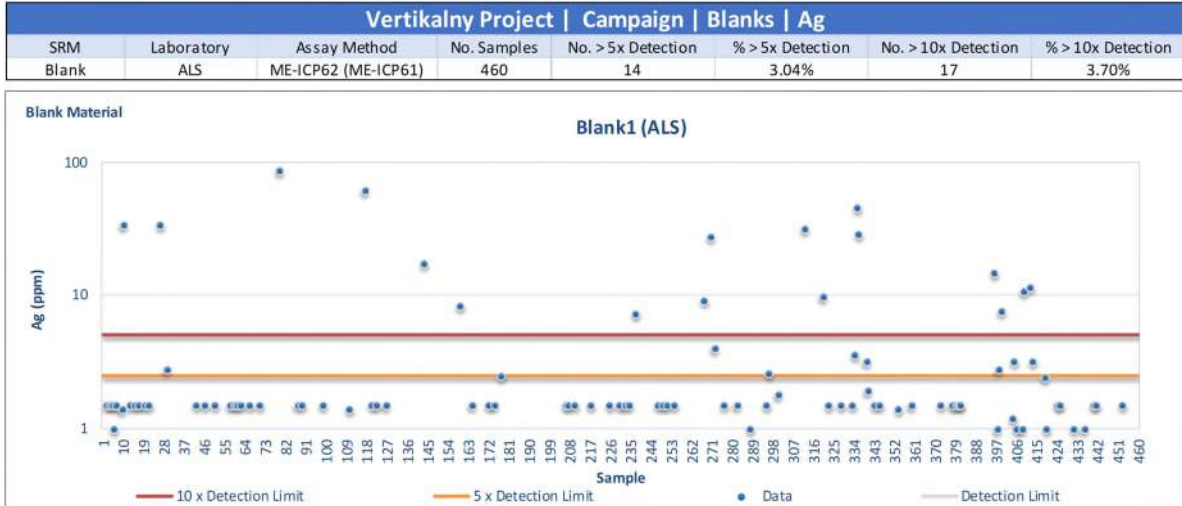


Figure 11.1: Blank Samples analysed for Ag using ME-ICP62 method

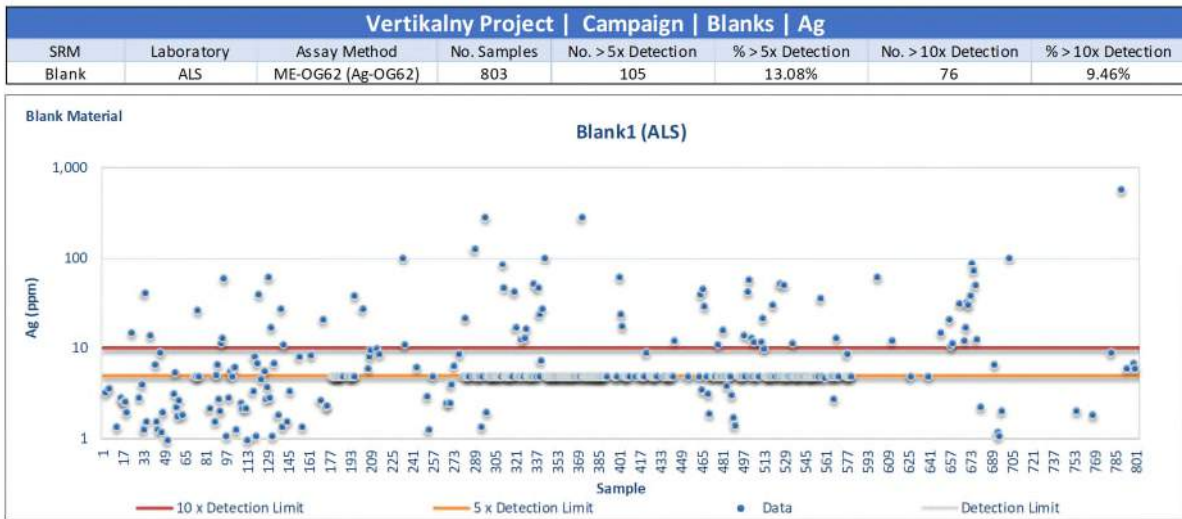
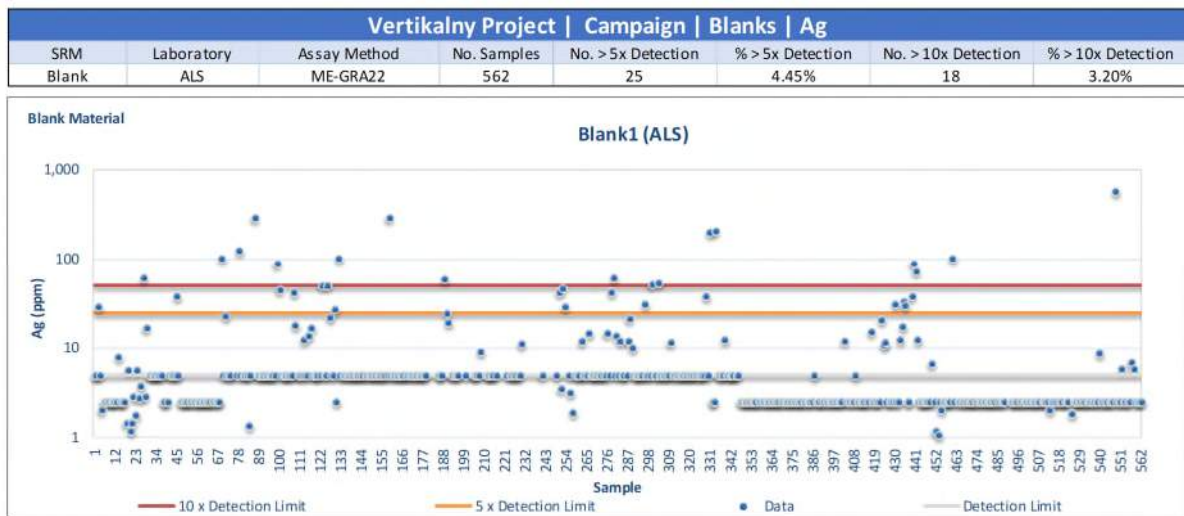


Figure 11.2: Blank Samples analysed for Ag using ME-OG62 method



**Figure 11.3: Blank Samples analysed for Ag using ME-GRA22 method**

Out of the blank sample failures, 2 samples had a grade >50g/t Ag for assay method ME-ICP62, 20 samples for method ME-ICP62, and 18 for ME-GRA22. It should be noted that some samples have been assayed with more than one assay method. A total of 21 unique samples have an Ag assay grade that exceeds 50g/t for at least one of the assay methods, and a further 56 between 10 - 50g/t Ag.

WAI has reviewed the assay data for sample preceding and following the blank samples (see Table 11.1 for selected examples). No clear pattern was observed to suggest either contamination in the sample preparation or that the blank material contained elevated levels of Ag mineralisation, there is evidence of both. However, there is also evidence of mislabelling of some samples. Therefore, it is suggested that moving forward the material used for blank samples is re-examined or replaced by material known not to carry any target mineralisation, pending the results of this re-examination. Commercially-sourced certified blank material would be recommended to eliminate any possibility of minor mineralisation. It is also recommended that the sample preparation apparatus is flushed with a quartz sand wash between samples and database management and transcribing results are regularly monitored.

**Table 11.1: Example Results for Blank Samples at Vertikalny**

BHID	Sample ID	Sample Type	Grade (g/t Ag)	BHID	Sample ID	Sample Type	Grade (g/t Ag)
V08-066	21487	Core	145.5	V08-023	27047	Core	253.2
V08-066	21488	Core	1,645.0	V08-023	27048	Core	1,560.0
V08-066	21489	Core	1,439.5	V08-023	27049	Core	1,196.0
<b>V08-066</b>	<b>21990</b>	<b>Blank</b>	<b>290.5</b>	<b>V08-023</b>	<b>27050</b>	<b>Blank</b>	<b>46.2</b>
V08-066	21991	Core	108.0	V08-023	27051	Core	1,374.0
V14-04	22852	Core	296.7	V08-023	27052	Core	1,380.0
V14-04	22853	Core	1,140.84	V08-023	27053	Core	1,520.0
V14-04	22854	Core	2,089.34	<b>V08-023</b>	<b>27054</b>	<b>Blank</b>	<b>29.0</b>
<b>V14-04</b>	<b>22855</b>	<b>Blank</b>	<b>103.27</b>	V08-023	27055	Core	49.0
V14-04	22856	Core	30.69	K-5065	17547	Trench	27.9

**Table 11.1: Example Results for Blank Samples at Vertikalny**

BHID	Sample ID	Sample Type	Grade (g/t Ag)	BHID	Sample ID	Sample Type	Grade (g/t Ag)
V08-066	21487	Core	136.0	K-5065	17548	Trench	666.5
V08-066	21488	Core	1,584.0	K-5065	17549	Trench	324.5
V08-066	21489	Core	1,480.0	<b>K-5065</b>	<b>17550</b>	<b>Blank</b>	<b>38.45</b>
<b>V08-066</b>	<b>21490</b>	<b>Blank</b>	<b>62.0</b>	K-5065	17551	Trench	185.5
V08-066	21491	Core	70.0	V13-15	8712	Core	3,455.82
V11-176	SB1100232	Core	0.25	V13-15	8713	Core	2,297.66
V11-176	SB1100233	Core	1.20	V13-15	8714	Core	720.99
V11-176	SB1100234	Core	2.90	<b>V13-15</b>	<b>8715</b>	<b>Blank</b>	<b>31.65</b>
<b>V11-176</b>	<b>SB1100235</b>	<b>Blank</b>	<b>101.0</b>	V13-15	8716	Core	162.50
V11-176	SB1100236	Core	6.60	V13-15	8717	Core	13.52

Elevated Pb and Zn grades were detected in 467 blank samples. Out of them 55 samples returned Pb grade that was twice the detection limit, and only 8 samples out of these 55 had Pb grade >0.25%. The results of blank samples analysis for Pb are presented on Figure 11.4.

In assays for Zn, 90 sampled returned Zn grade that was twice the accepted detection limit, 20 samples out of them had Zn grade >0.25%. The results of blank samples analysis for Zn are presented on Figure 11.5.

In general, the results of blank samples analysis for Pb and Zn are considered satisfactory though Pb and Zn are not included in the Mineral Resource Estimate.

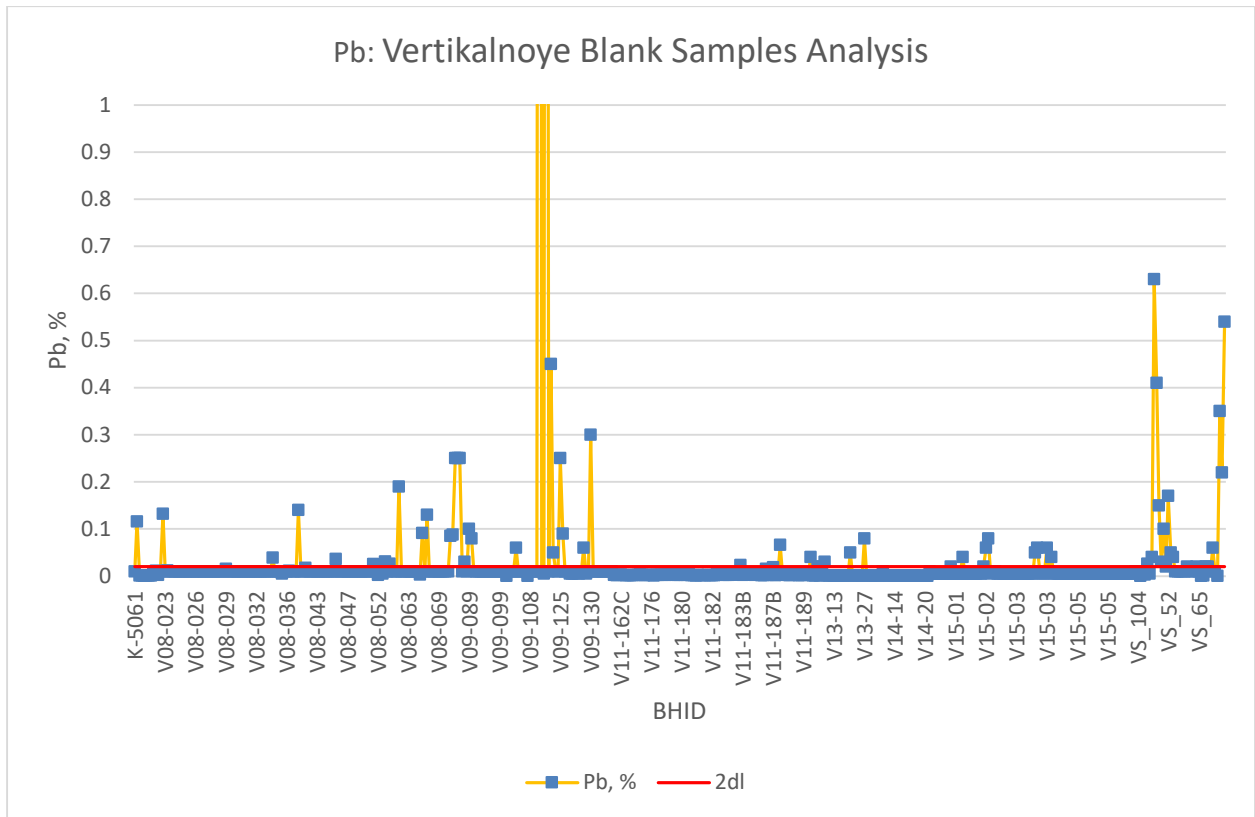


Figure 11.4: Blank Samples Analysed for Pb on Vertikalny

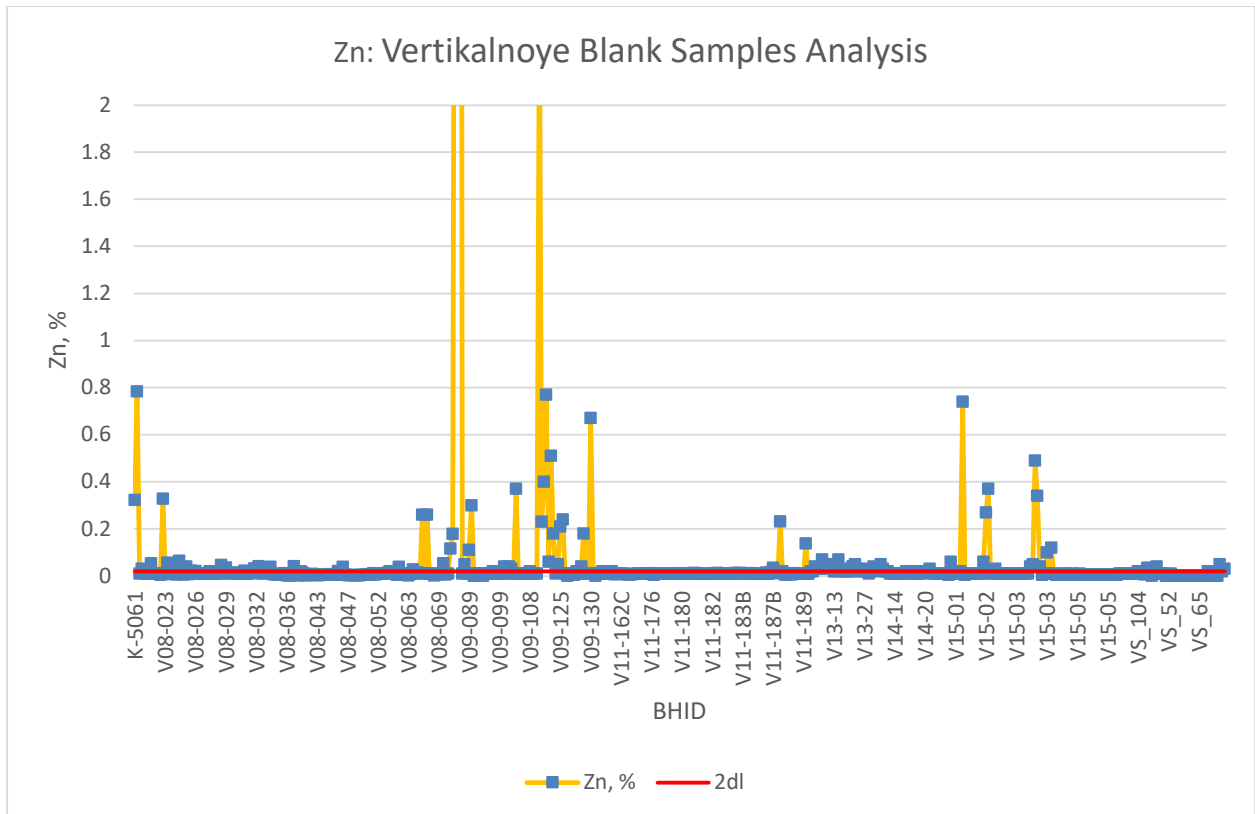


Figure 11.5: Blank Samples Analysed for Zn on Vertikalny



### 11.6.1.2 Certified Reference Materials (CRM)

Eighteen certified reference materials (CRMs) sourced from ORE Research & Exploration Pty Ltd, GEOSTATS Pty Ltd (Australia), STC Minstandard of St Petersburg, and Irgiredmet OJSC of Irkutsk (Table 11.2).

<b>Table 11.2: List of Certified Reference Materials</b>		
<b>NoNo</b>	<b>CRM</b>	<b>Manufacturer</b>
1	OREAS 600	ORE Research & Exploration Pty Ltd, Australia
2	OREAS 605	
3	GBM 906-6	GEOSTATS Pty Ltd, Australia
4	GBM 913-13	
5	GBM 998-9	
6	GBM303-1	
7	GBM310-16	
8	GBM906-7	
9	GBM909-11	
10	GBM913-13	
11	GBM997-4	
12	СОП 01-2016 (SOP 01-2016)	Irgiredmet OJSC
13	СОП 02-2016 (SOP 02-2016)	
14	СОП 03-2016 (SOP 03-2016)	
15	MST SG 130i	STC Minstandard LLC, Russia
16	MST GS 161f	
17	MST SG 186	
18	MST SG 151h	

The recommended values and number of assays for each CRM are listed in Table 11.3. Laboratory certificates have been provided for all but one of the CRMs. CRM limits are provided as permitted allowed absolute error (based on >95% of samples being within that target) rather than the more usual standard deviation limits.

In general, a good precision of the results of laboratory assays for Ag and certified valued was noted. The highest deviations are typical for CRMs with low Ag grades (<5g/t) that are close to the assays' detection limits.

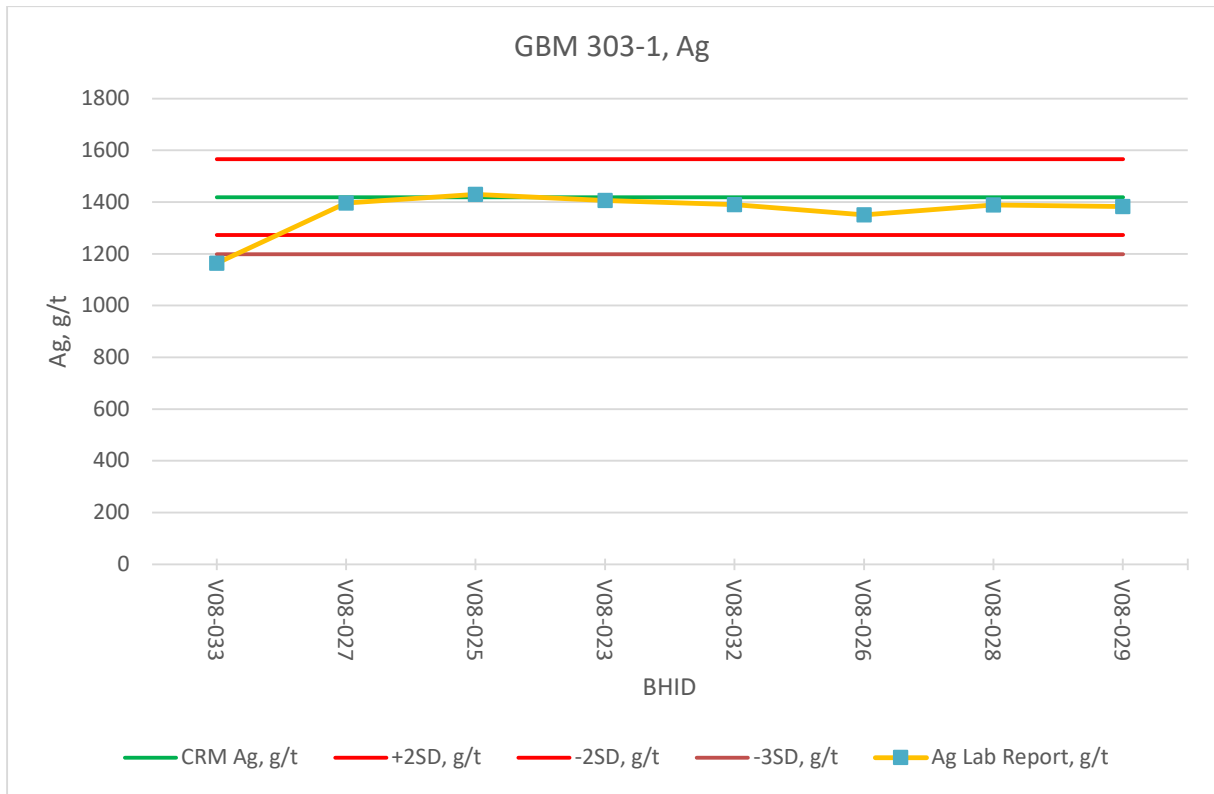
The majority of assay results beyond allowed error limits with meaningful zinc contents were shown for GBM 310-16 and GBM 909-11 CRMs generally returning lower Zn grades in comparison with CRMs.

Despite of this, WAI considers the risk to the MRE as insignificant.

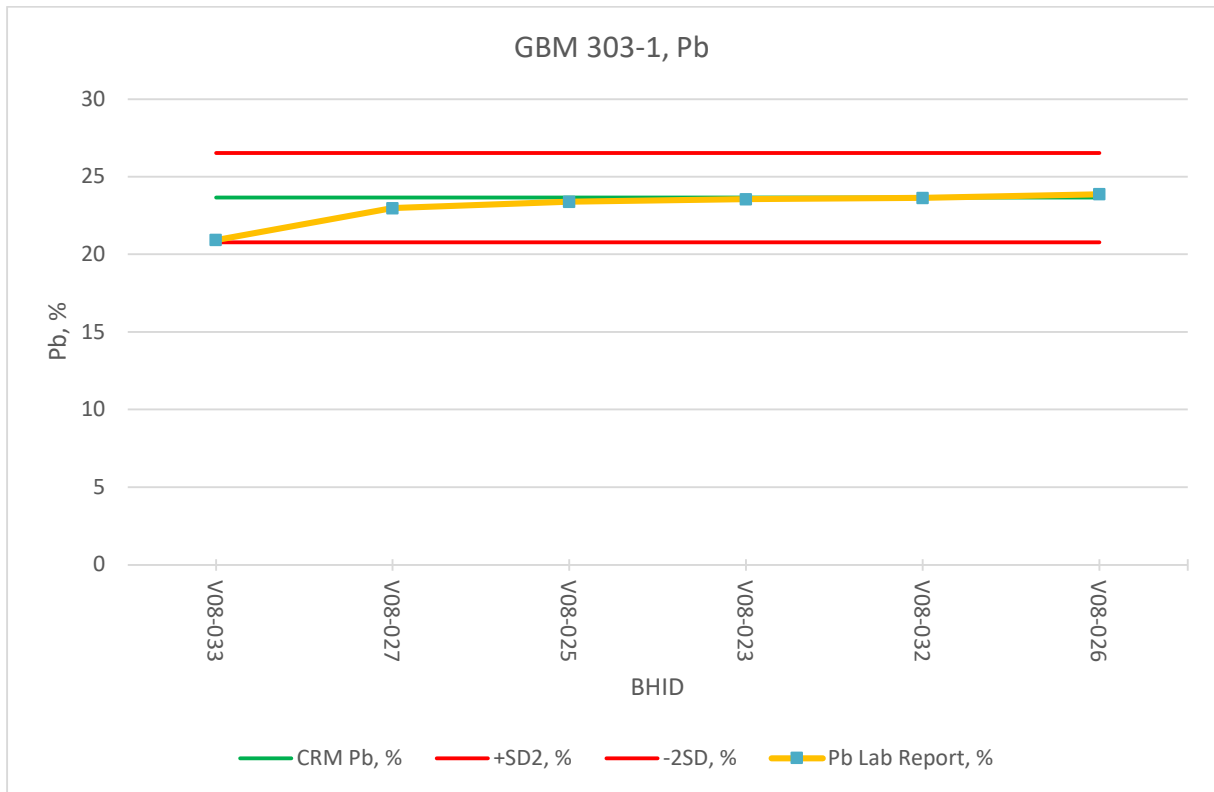
**Table 11.3: Summary of CRMs Data for Vertikalny**

CRM	Metal, Unit	Grade	Standard Deviation	Expanded Uncertainty	No of CRMs	Beyond Allowed Absolute Error	% of Satisfactory Assays
OREAS 600	Ag, g/t	24.8	1.01		3	0	100.0%
	Zn, %	0.255	0.008		NA		
	Pb, g/t	994	69		NA		
OREAS 605	Ag, g/t	972	27.8		1	0	100.0%
	Zn, %	0.216	0.009		1	0	100.0%
	Pb, g/t	1297	136		1	0	100.0%
GBM 906-6	Ag, g/t	389.7	21.1		311	4	98.7%
	Zn, g/t	210	14		151	32	78.8%
	Pb, g/t	290	14		151	27	82.1%
GBM 913-13	Ag, g/t	74.1	3.9		12	0	100.0%
	Zn, g/t	386	nr		12	3	75.0%
	Pb, g/t	125	nr		12	4	66.7%
GBM 998-9	Ag, g/t	101.2	4.8		156	11	92.9%
	Zn, g/t	27	10		89	very low grades	
	Pb, g/t	8	4		89	very low grades	
GBM303-1	Ag, g/t	1,419.6	73.5		8	1	87.5%
	Zn, g/t	2,8750	1,529		6	0	100.0%
	Pb, g/t	23,6561	14,346		6	0	100.0%
GBM310-16	Ag, g/t	314.3	14.9		27	0	100.0%
	Zn, g/t	170,201	6,825		27	8	70.4%
	Pb, g/t	112,603	5,008		27	5	81.5%
GBM906-7	Ag, g/t	0.9	0.3		1	0	100.0%
	Zn, g/t	51	11		1	0	100.0%
	Pb, g/t	8	4		1	0	100.0%
GBM909-11	Ag, g/t	25.5	1.7		15	0	100.0%
	Zn, g/t	19,486	591		15	6	60.0%
	Pb, g/t	2,074	103		15	1	93.3%
GBM913-13	Ag, g/t	74.1	3.9		16	0	100.0%
	Zn, g/t	386	nr		16	0	100.0%
	Pb, g/t	125	nr		16	0	100.0%
GBM997-4	Ag, g/t	287.9	38.2		105	3	97.1%
	Zn, g/t	119	13		62	very low grades	
	Pb, g/t	159	17		62	very low grades	
СОП 01-2016 (SOP 01-2016)	Ag, g/t	3,21		+/- 0.28	38	16	57.9%
	Zn, %	0,129		+/- 0.007	11	2	81.8%
	Pb, %	0,083		+/- 0.004	11	4	63.6%
СОП 02-2016 (SOP 02-2016)	Ag, g/t	73.7		+/- 3.2	40	0	100.0%
	Zn, %	0.86		+/- 0.02	20	1	95.0%
	Pb, %	2.45		+/-0.09	20	1	95.0%
СОП 03-2016 (SOP 03-2016)	Ag, g/t	124.4		+/- 6.2	20	1	95.0%
	Zn, %	50.3		+/- 0.2	12	very low grades	
	Pb, %	1.37		+/-0.09	13	0	100.0%
MST SG 130i	Ag, g/t	171.8		+/-4.5	9	0	100.0%
MST GS 161f	Ag, g/t	1.49		NA	1		
MST SG 186	Ag, g/t	36		NA	32		
	Zn, %	0.0053		NA	10		
	Pb, %	0.035		NA	10		
MST SG 151h	Ag, g/t	78.3		+/-2.2	8	0	100.0%

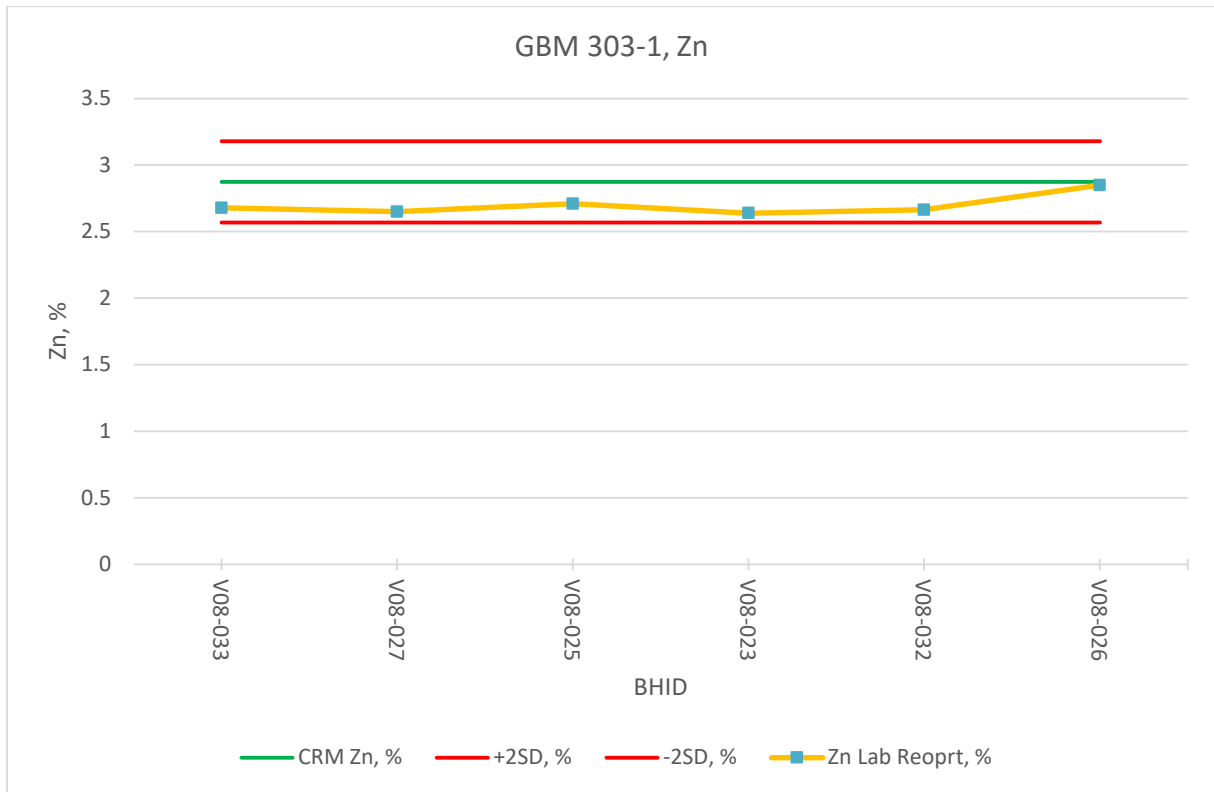
There are no data on allowed absolute error for CRMs GS 161f (one sample) and MST SG 186 (32 samples) therefore results for these CRMs were not considered. The results of CRMs analyses are illustrated on Figure 11.6 to Figure 11.35.



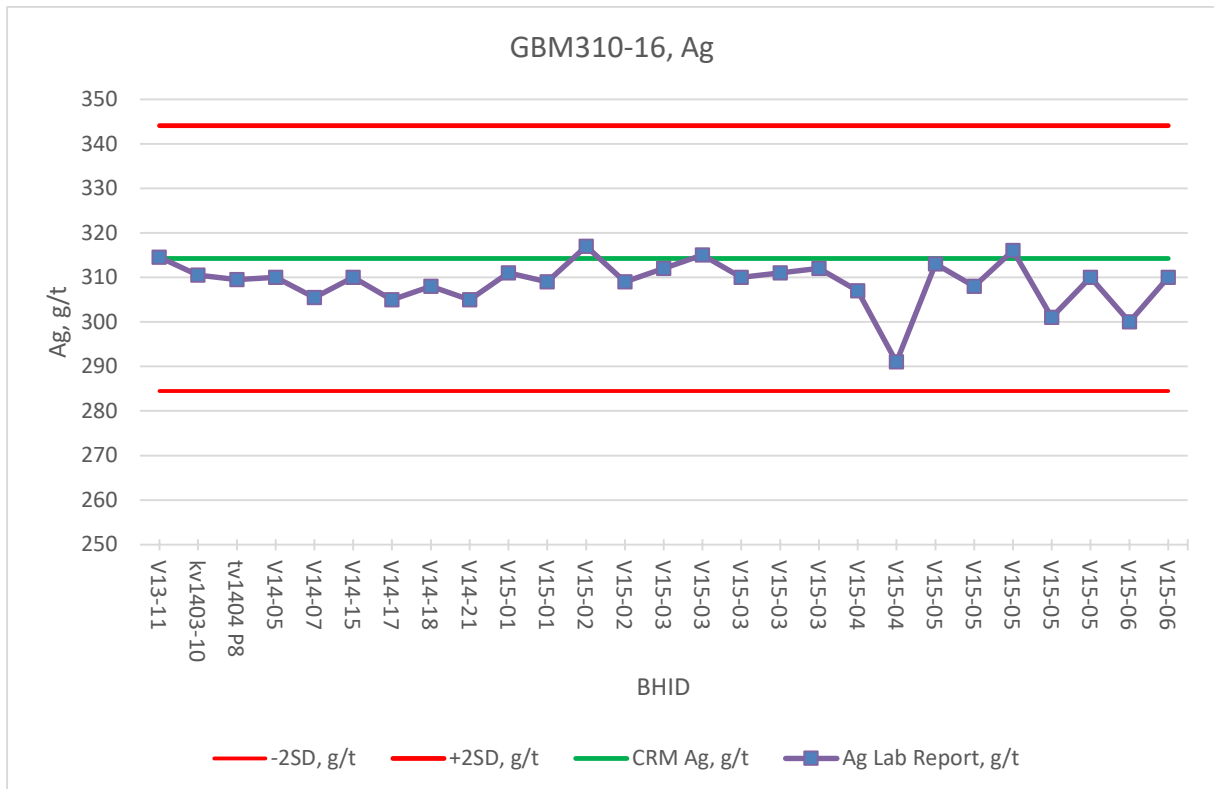
**Figure 11.6: GBM 303-1, Ag, CRM Assaying Results**



**Figure 11.7: GBM 303-1, Pb, CRM Assaying Results**



**Figure 11.8: GBM 303-1, Zn, CRM Assaying Results**



**Figure 11.9: GBM 310-16, Ag, CRM Assaying Results**

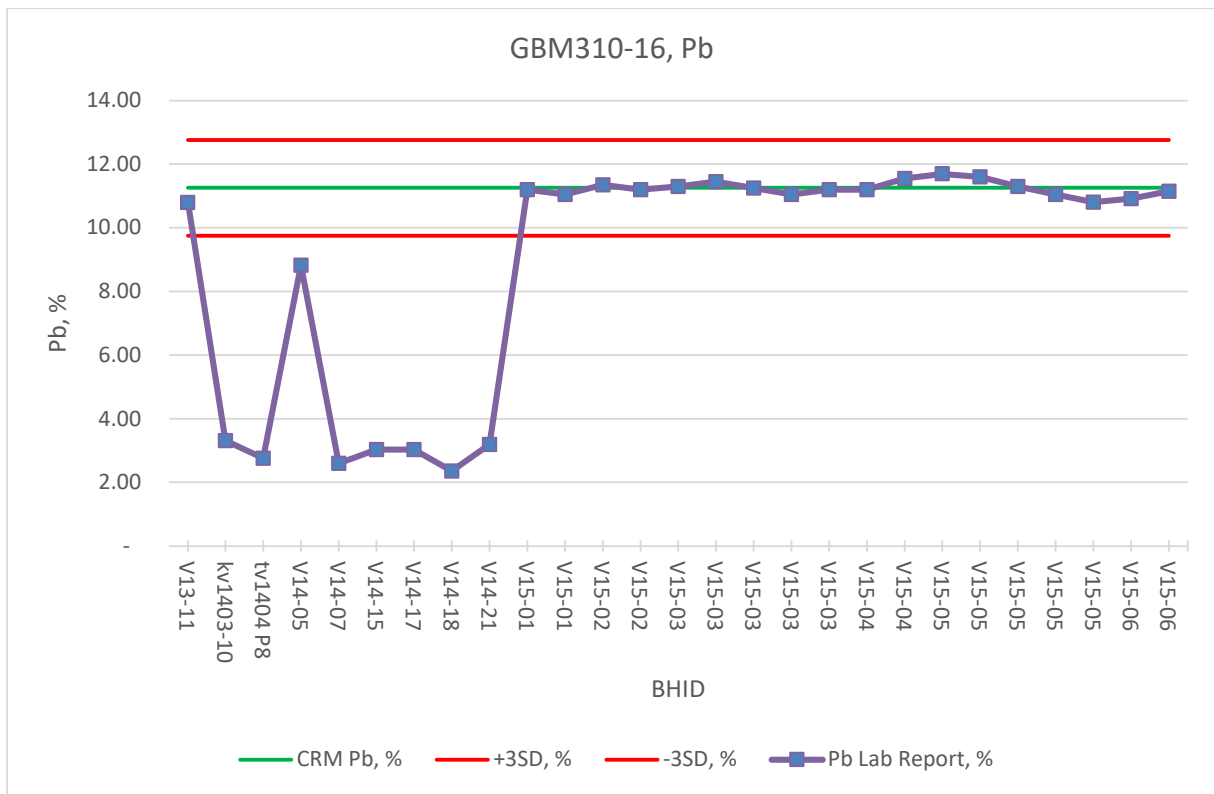


Figure 11.10: GBM 310-16, Pb, CRM Assaying Results

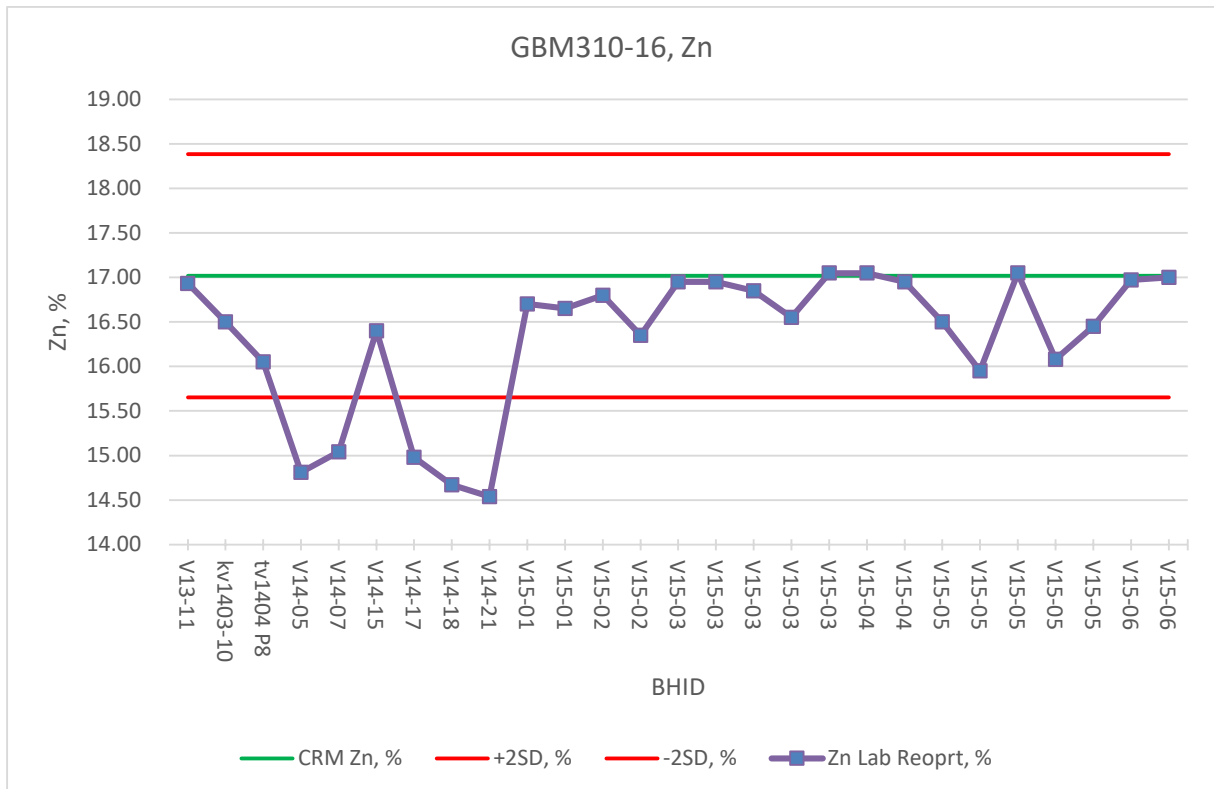
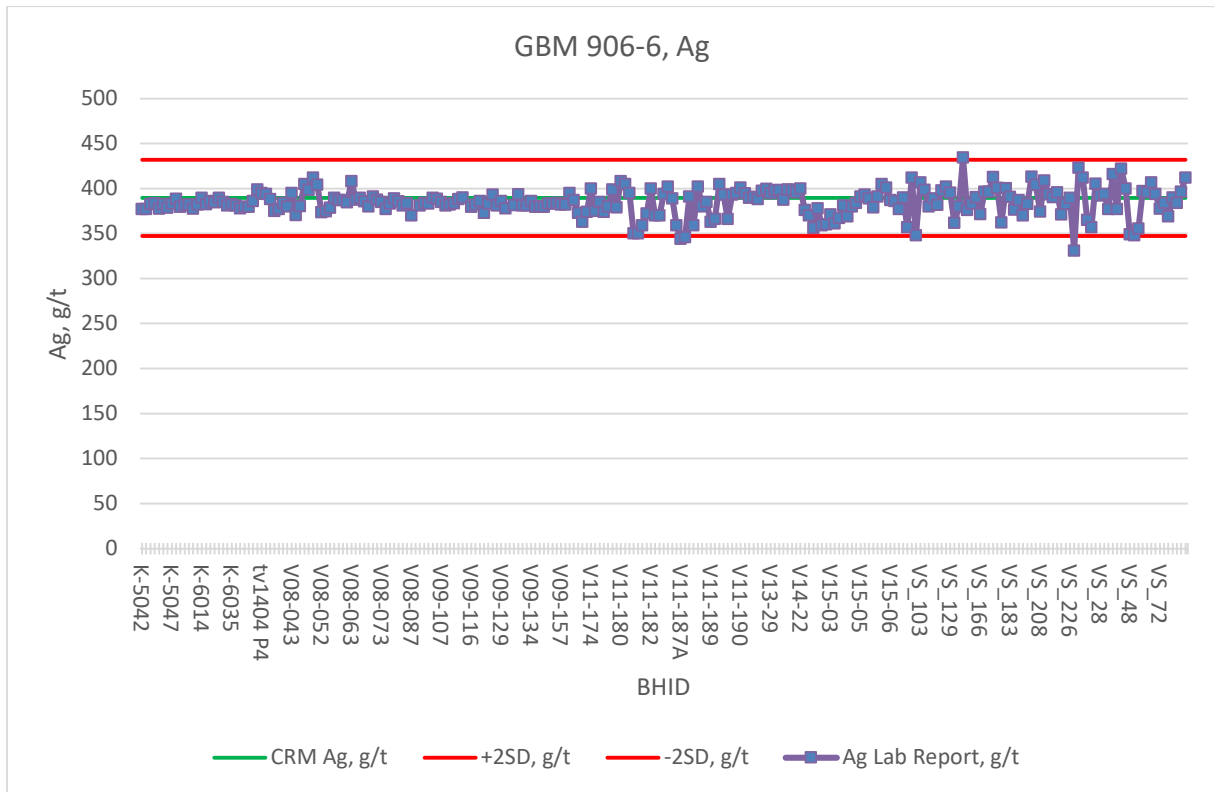
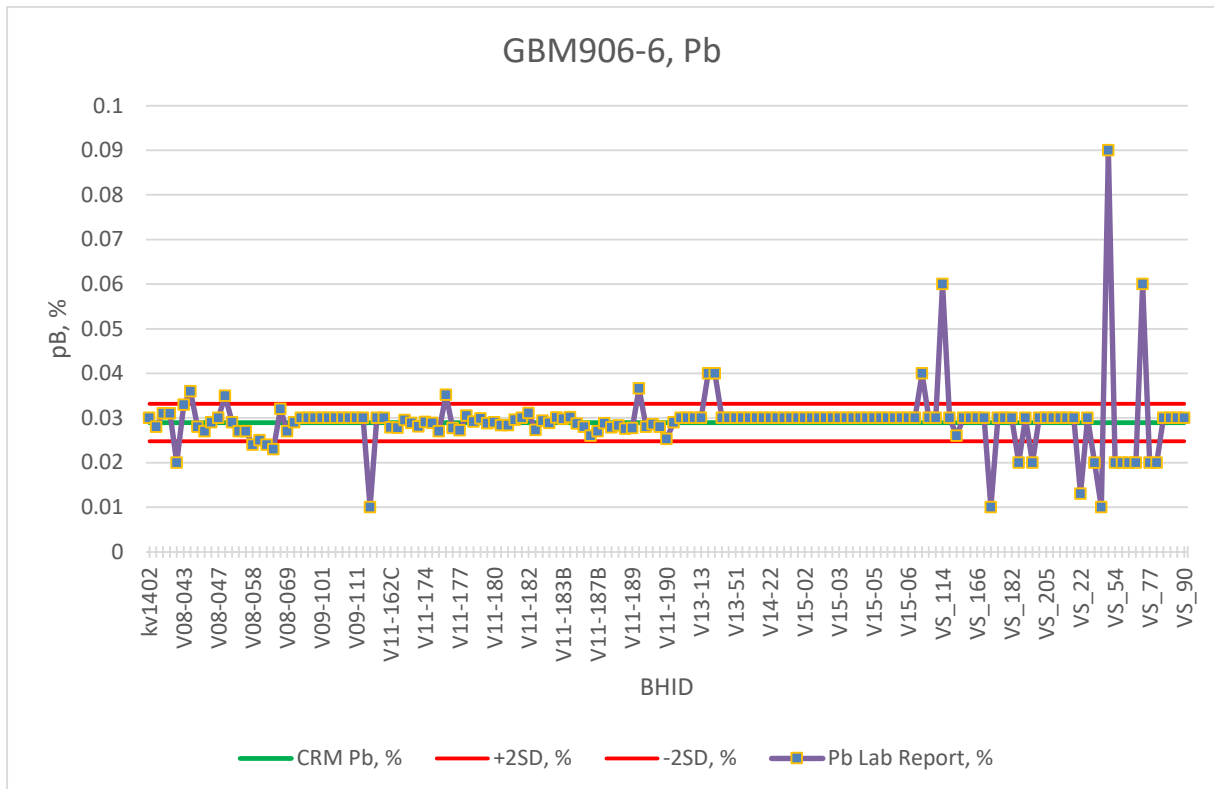


Figure 11.11: GBM 310-16, Zn, CRM Assaying Results



**Figure 11.12: GBM 906-6, Ag, CRM Assaying Results**



**Figure 11.13: GBM 906-6, Pb, CRM Assaying Results**

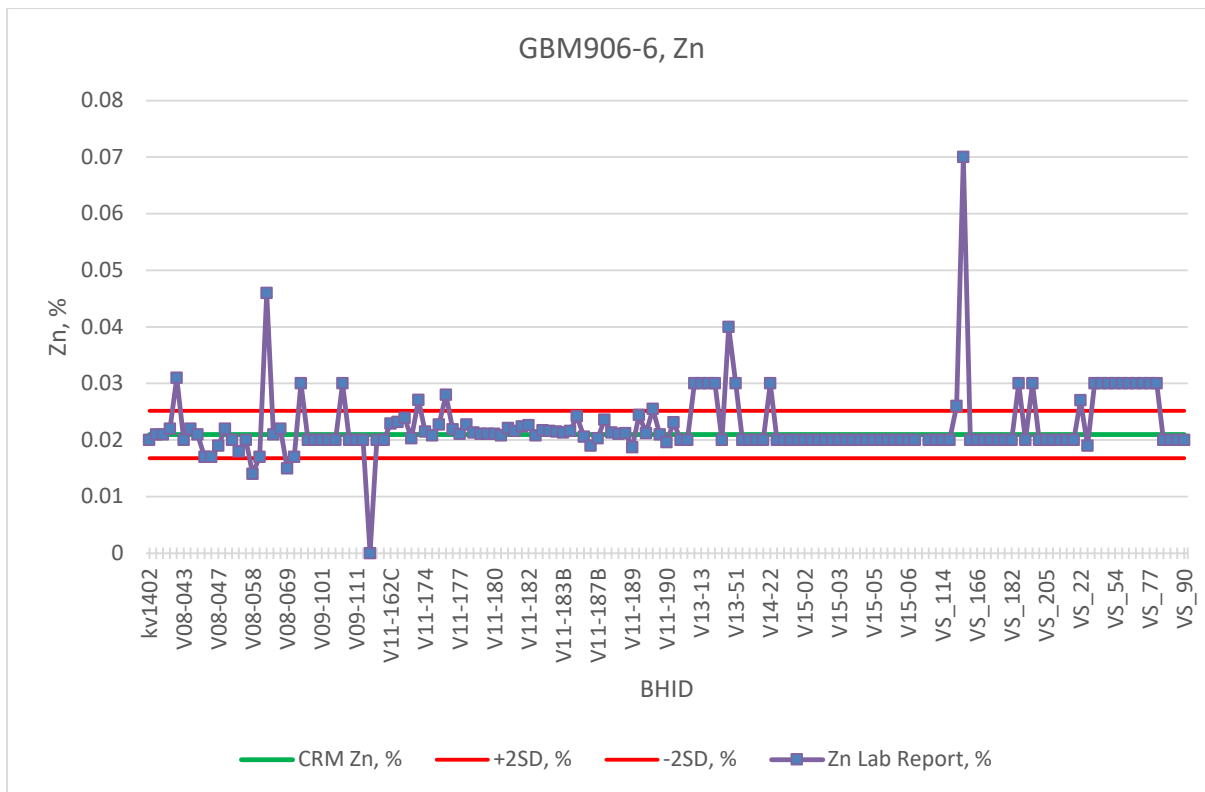


Figure 11.14: GBM 906-6, Zn, CRM Assaying Results

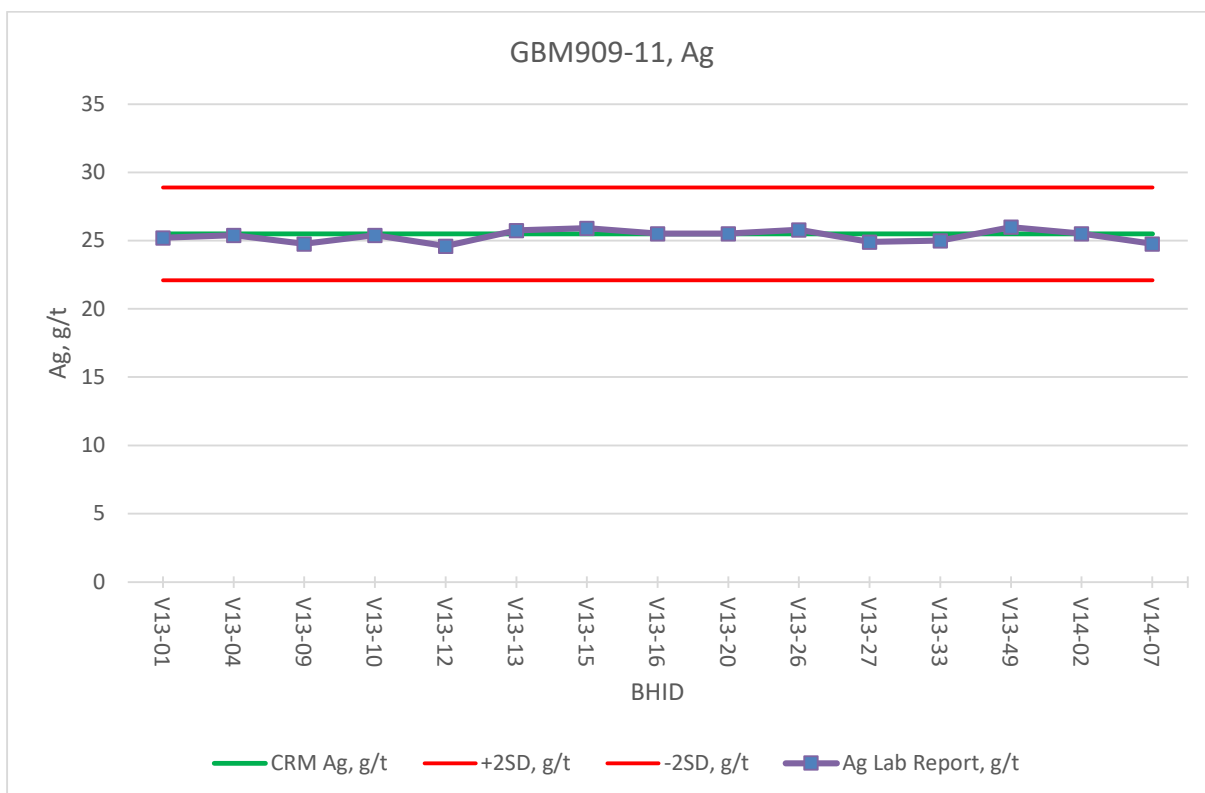
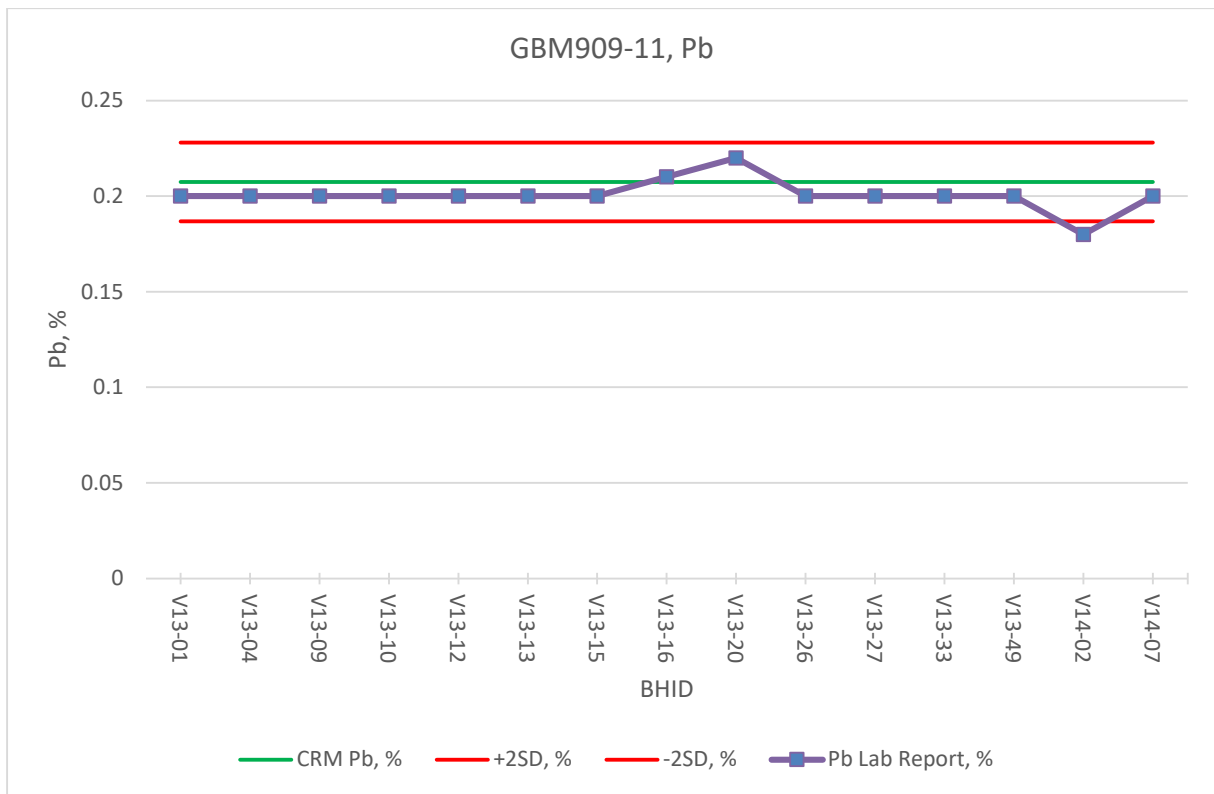
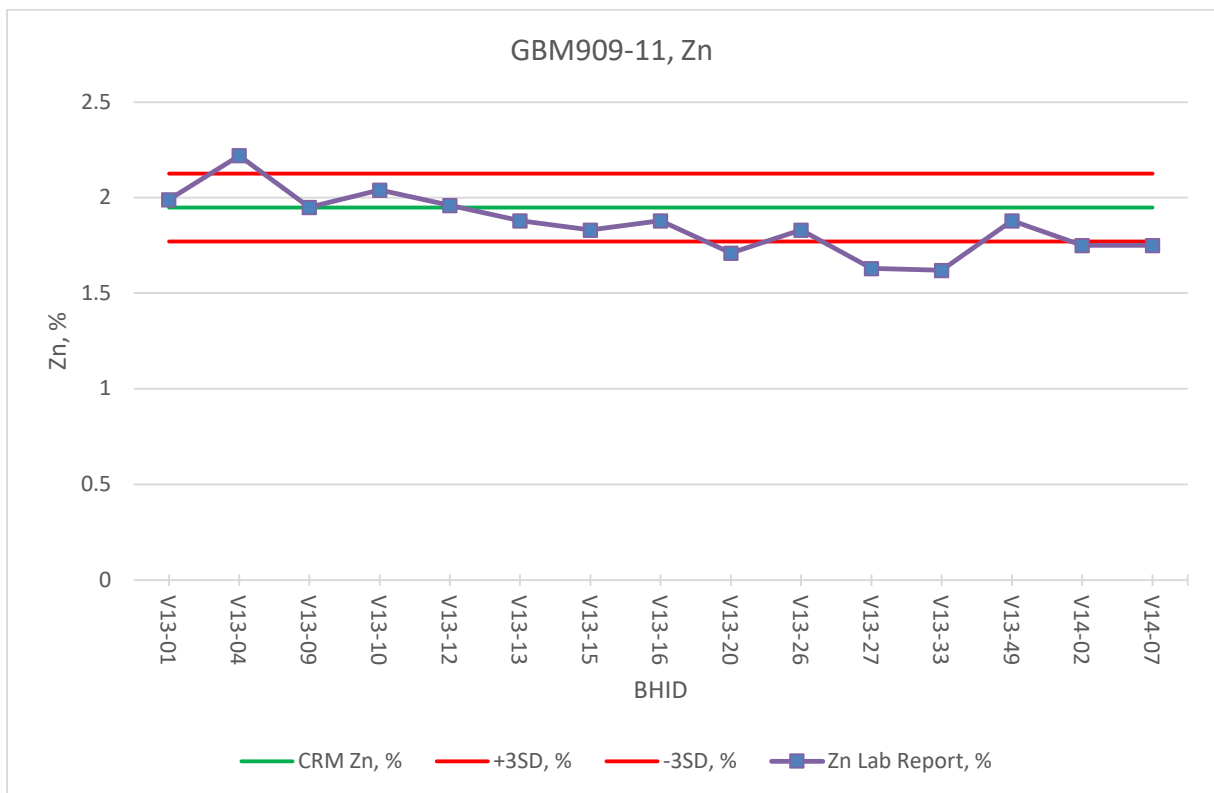


Figure 11.15: GBM 909-11, Ag, CRM Assaying Results

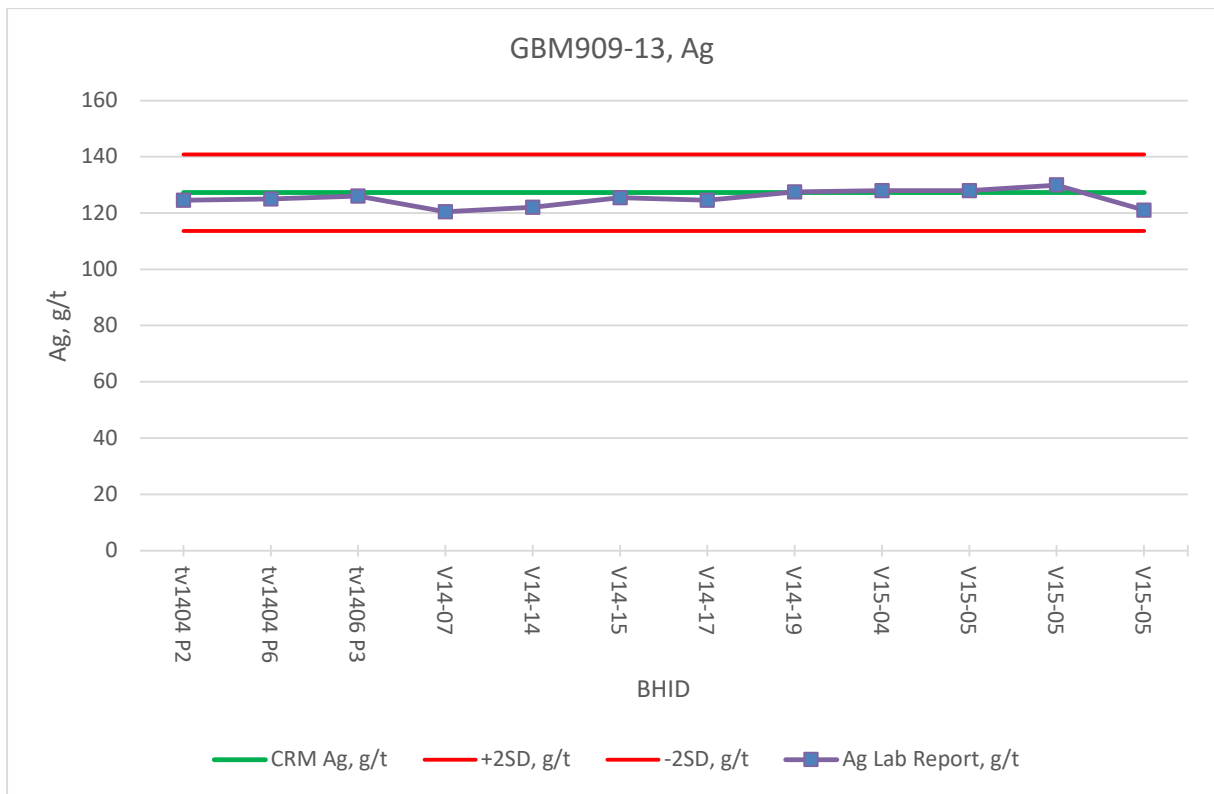


**Figure 11.16: GBM 909-11, Pb, CRM Assaying Results**

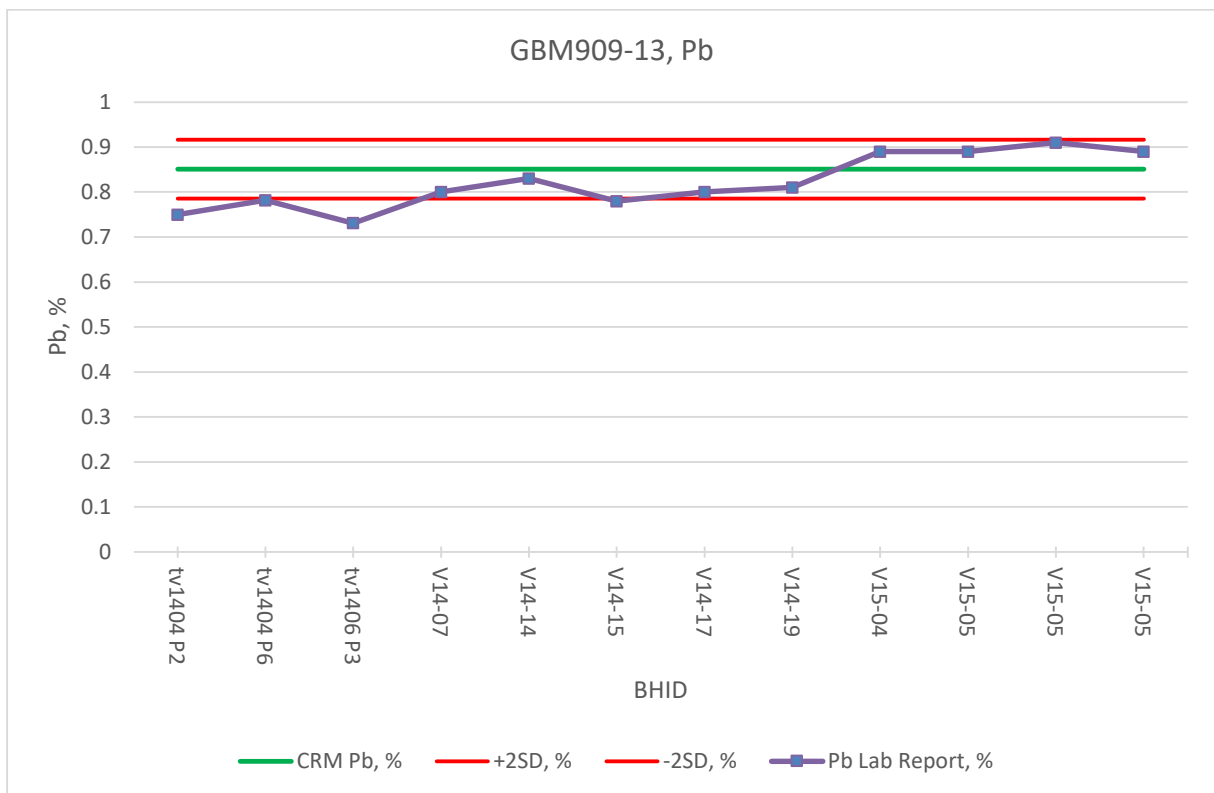


**Figure 11.17: GBM 909-11, Zn, CRM Assaying Results**

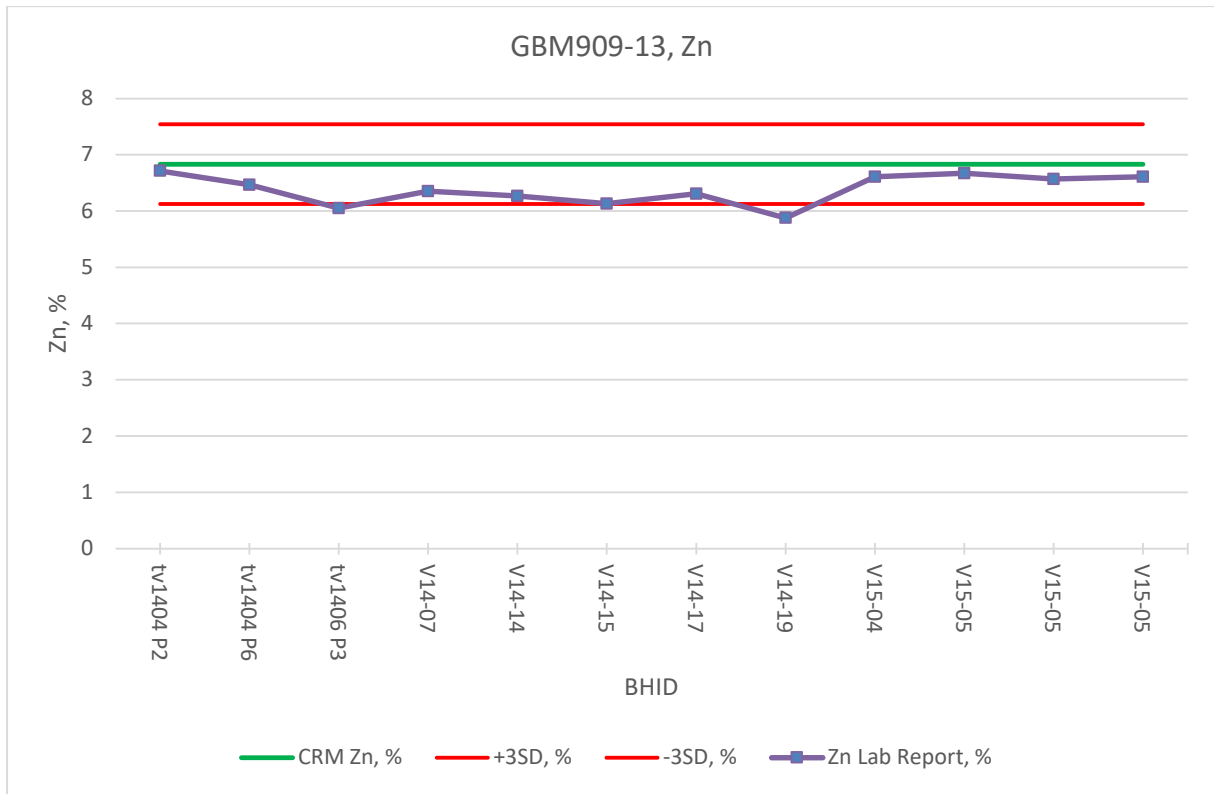




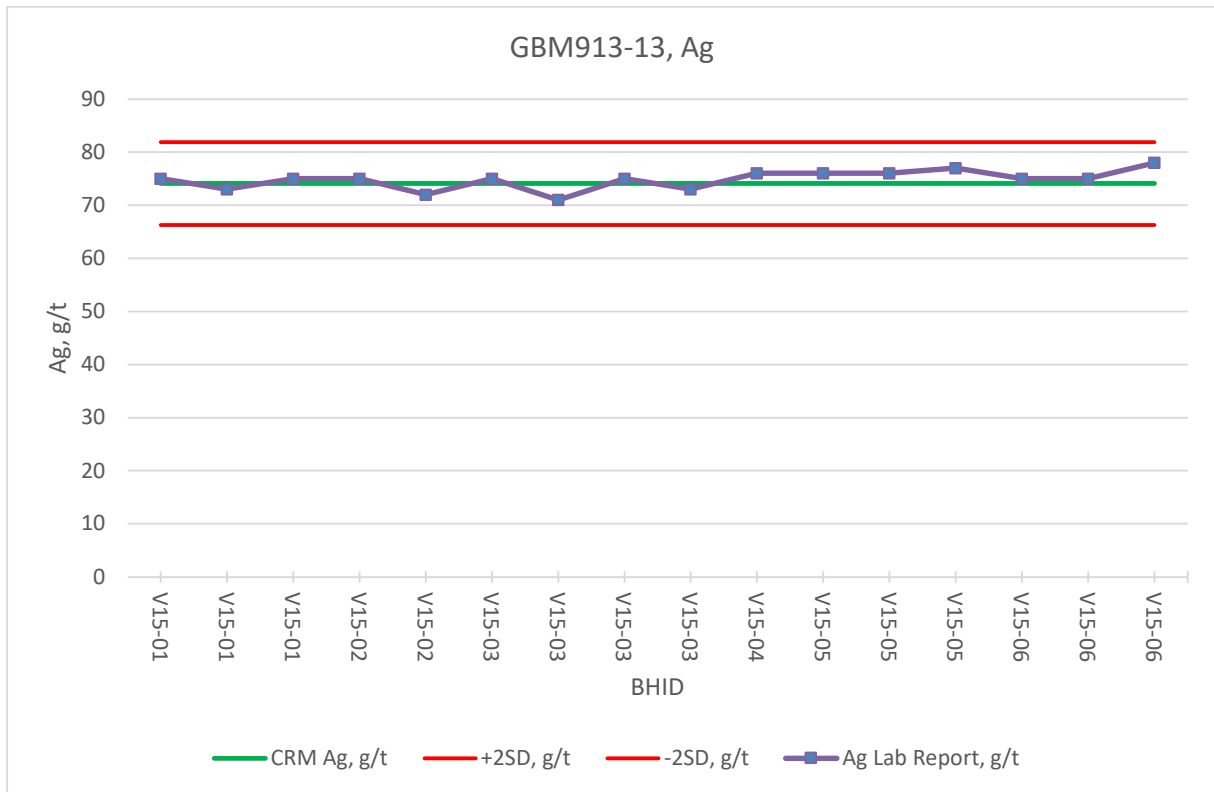
**Figure 11.18: GBM 909-13, Ag, CRM Assaying Results**



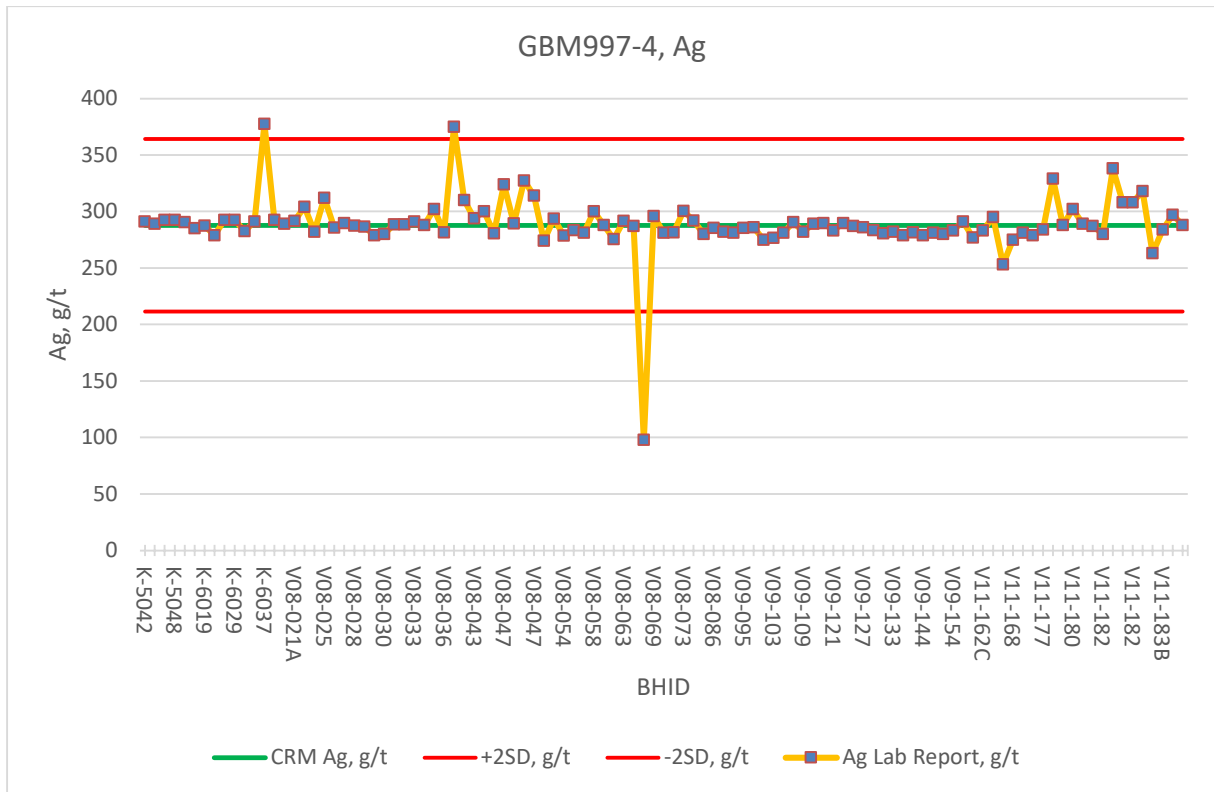
**Figure 11.19: GBM 909-13, Pb, CRM Assaying Results**



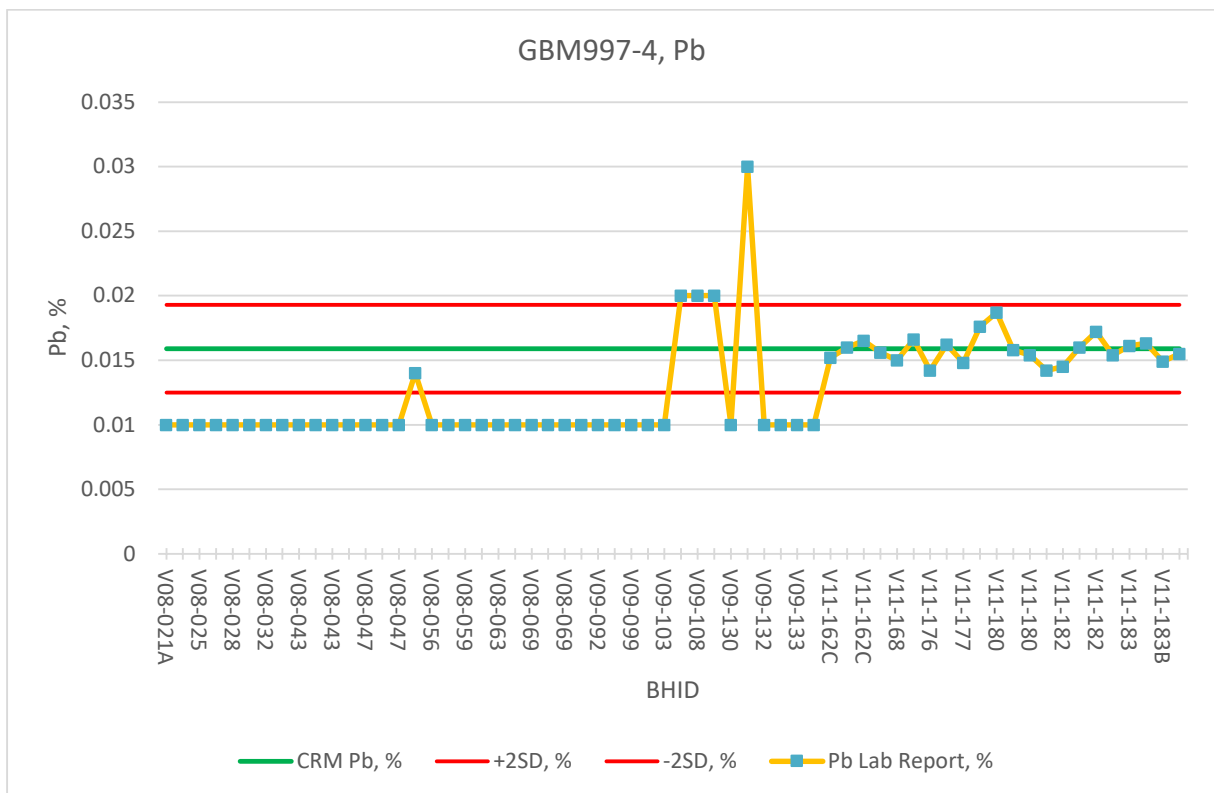
**Figure 11.20: GBM 909-13, Zn, CRM Assaying Results**



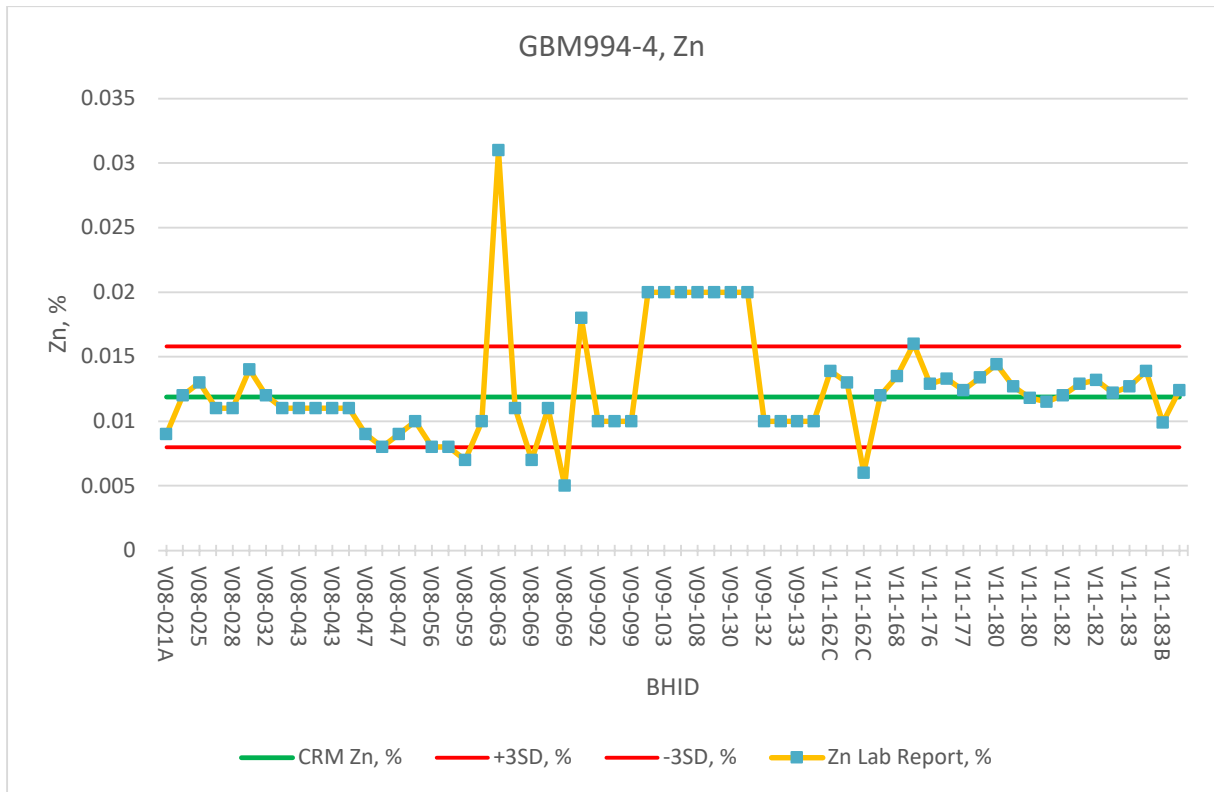
**Figure 11.21: GBM 913-13, Ag, CRM Assaying Results**



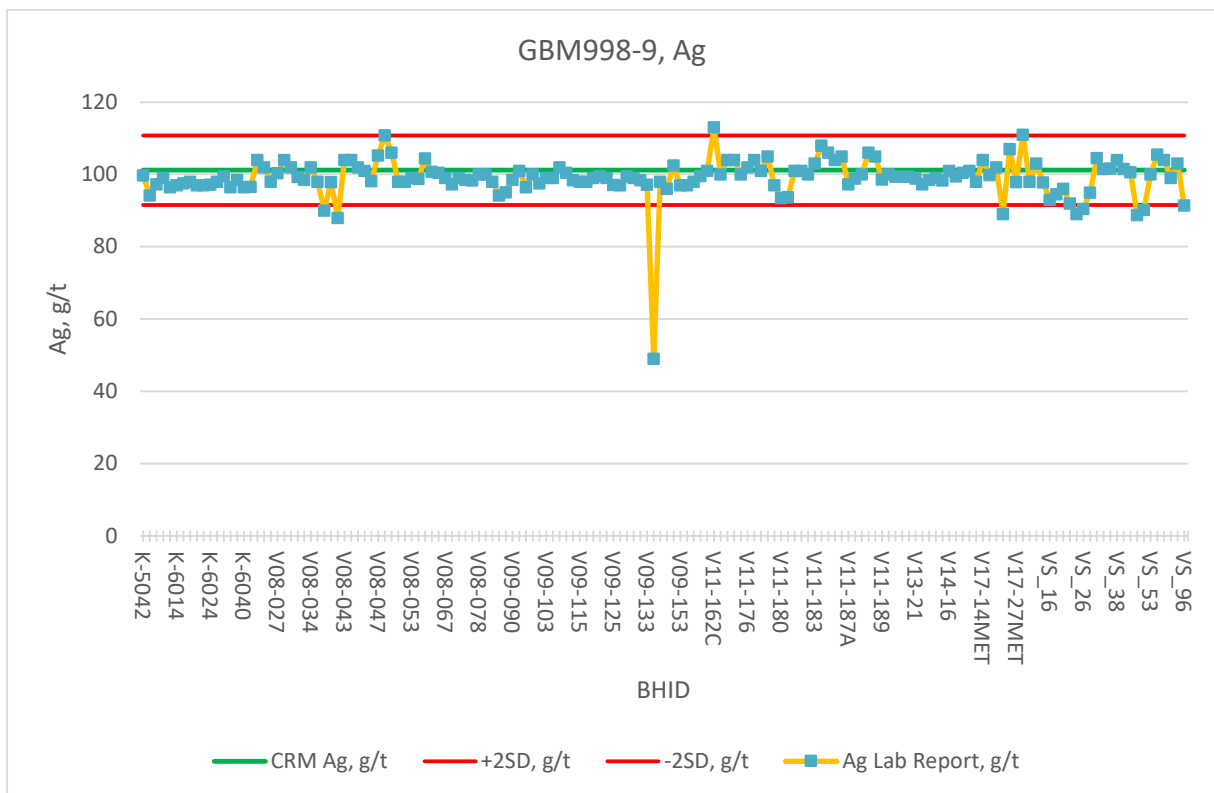
**Figure 11.22: GBM 997-4, Ag, CRM Assaying Results**



**Figure 11.23: GBM 997-4, Pb, CRM Assaying Results**



**Figure 11.24: GBM 997-4, Zn, CRM Assaying Results**



**Figure 11.25: GBM 998-9, Ag, CRM Assaying Results**

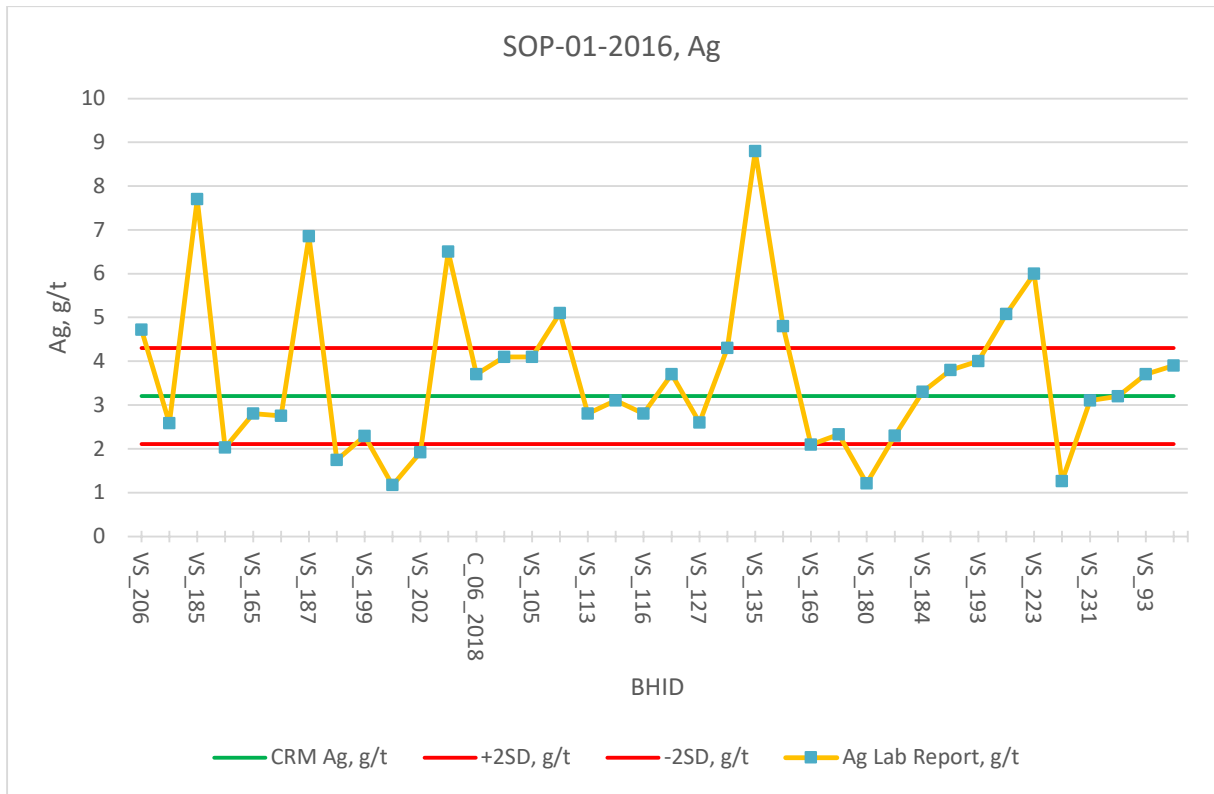


Figure 11.26: SOP-01-2016, Ag, CRM Assaying Results

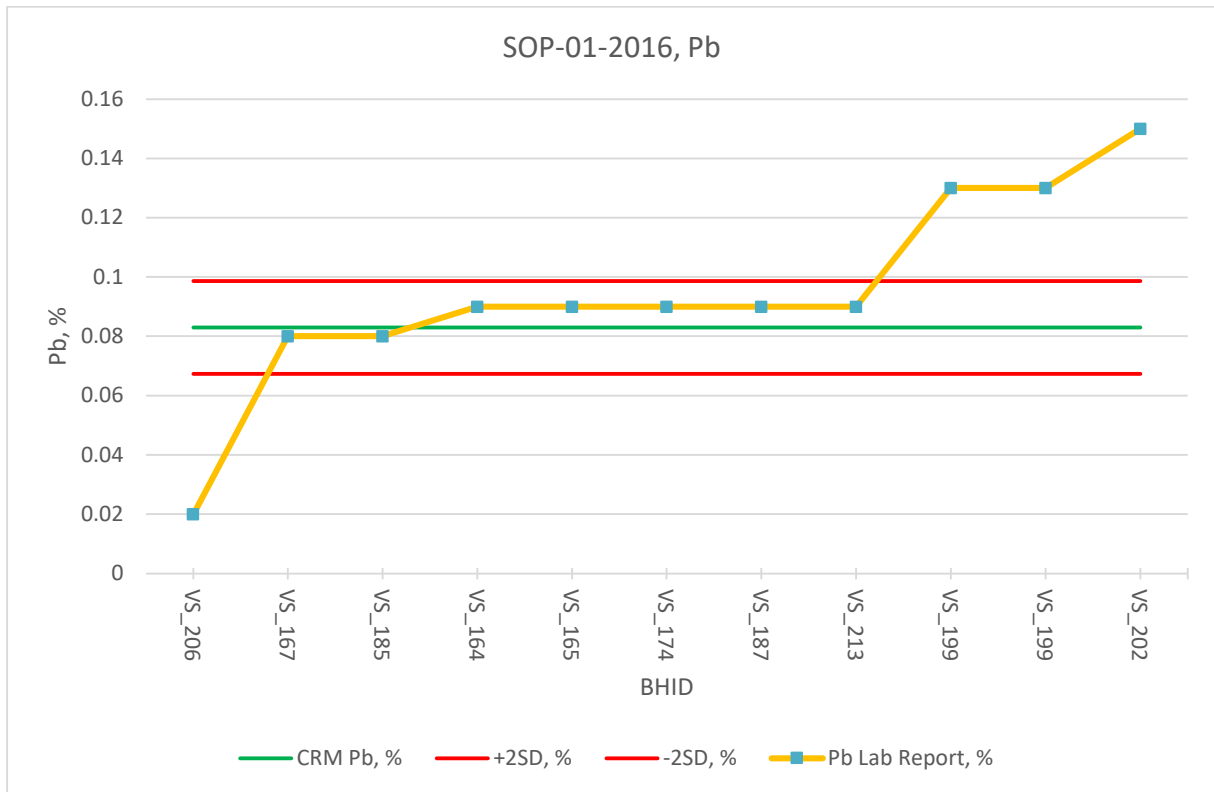


Figure 11.27: SOP-01-2016, Pb, CRM Assaying Results

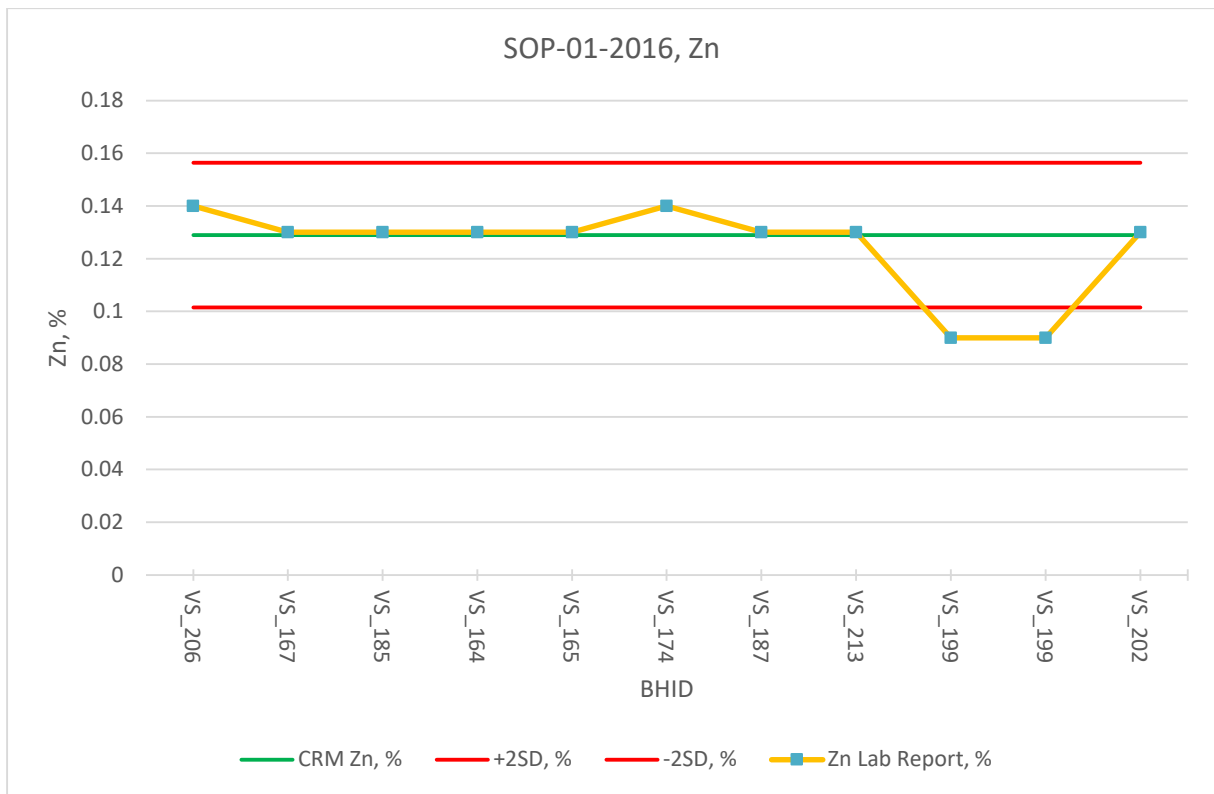


Figure 11.28: SOP-01-2016, Zn, CRM Assaying Results

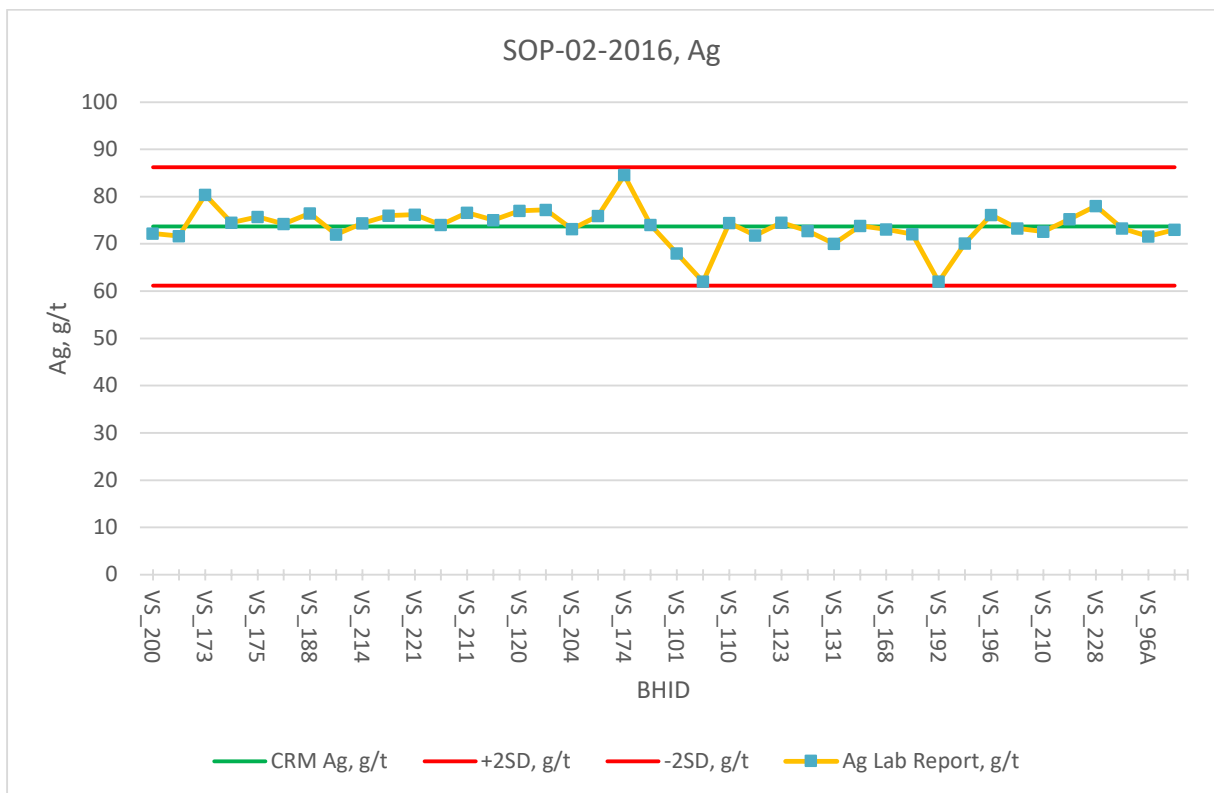


Figure 11.29: SOP-02-2016, Ag, CRM Assaying Results

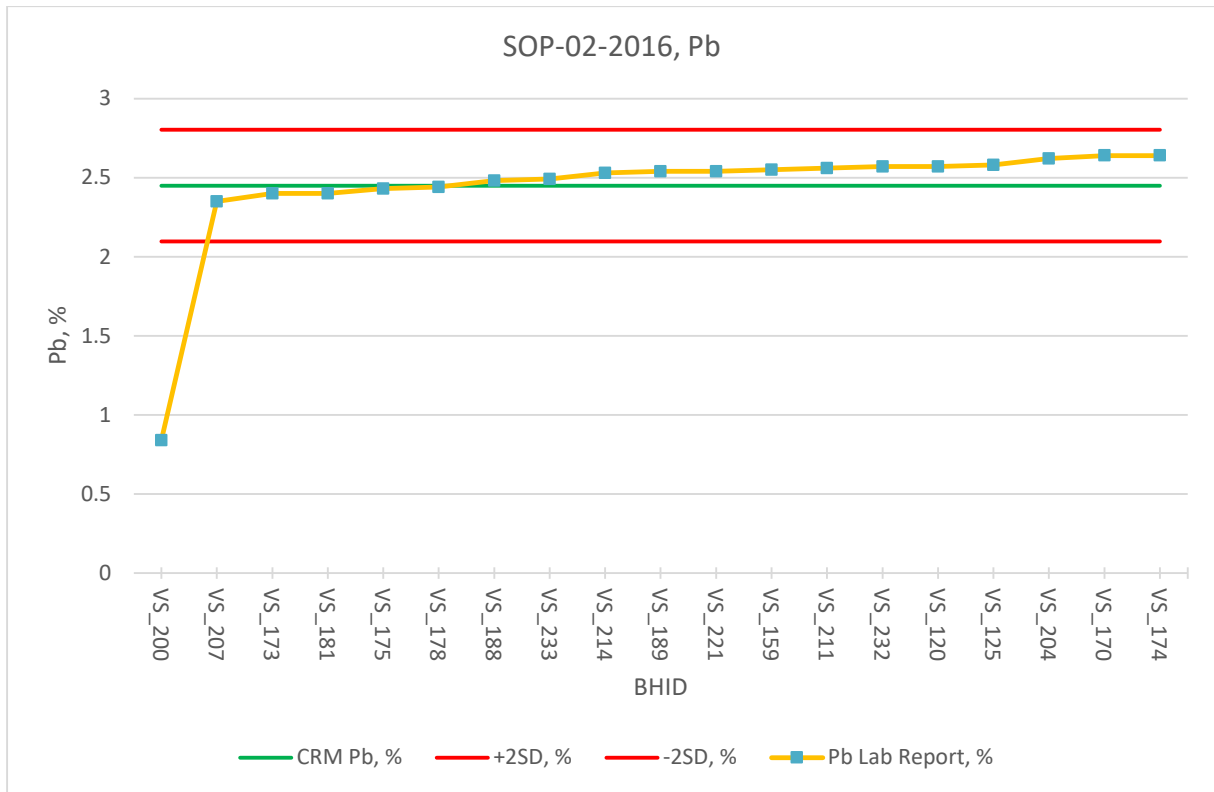


Figure 11.30: SOP-02-2016, Pb, CRM Assaying Results

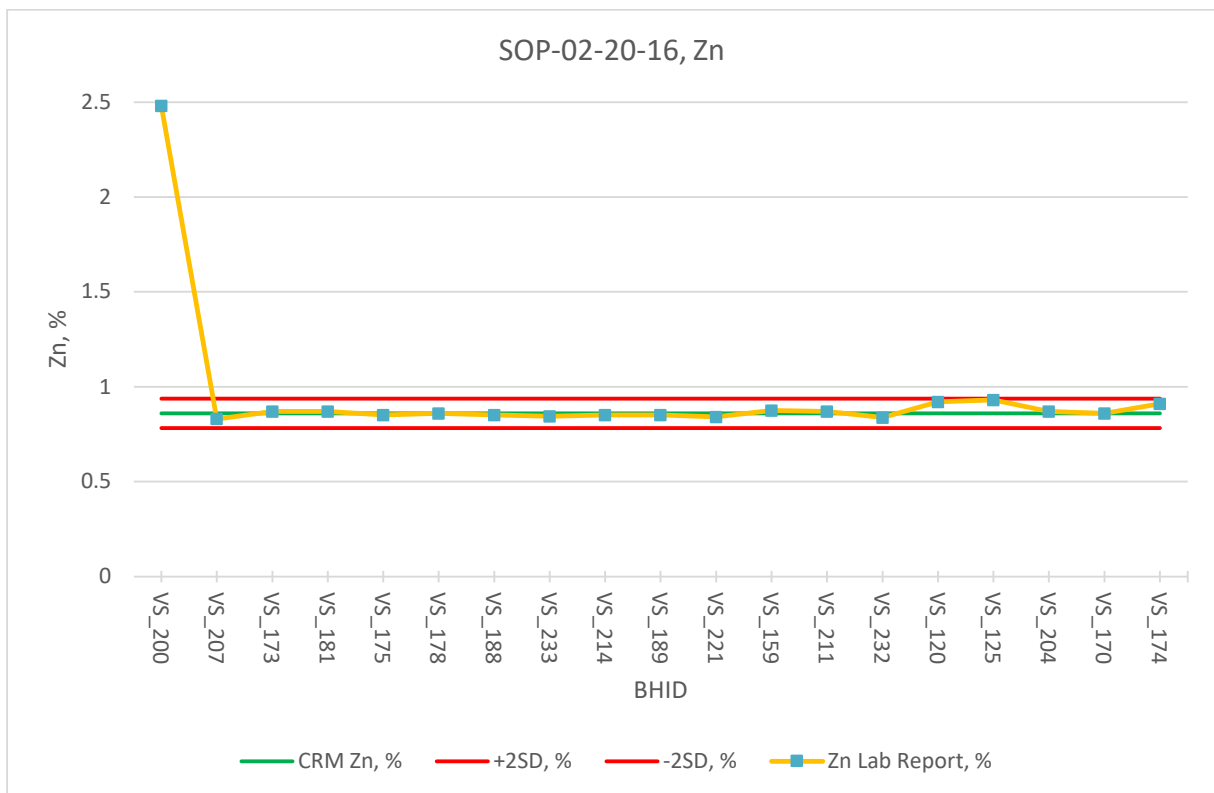


Figure 11.31: SOP-02-2016, Zn, CRM Assaying Results

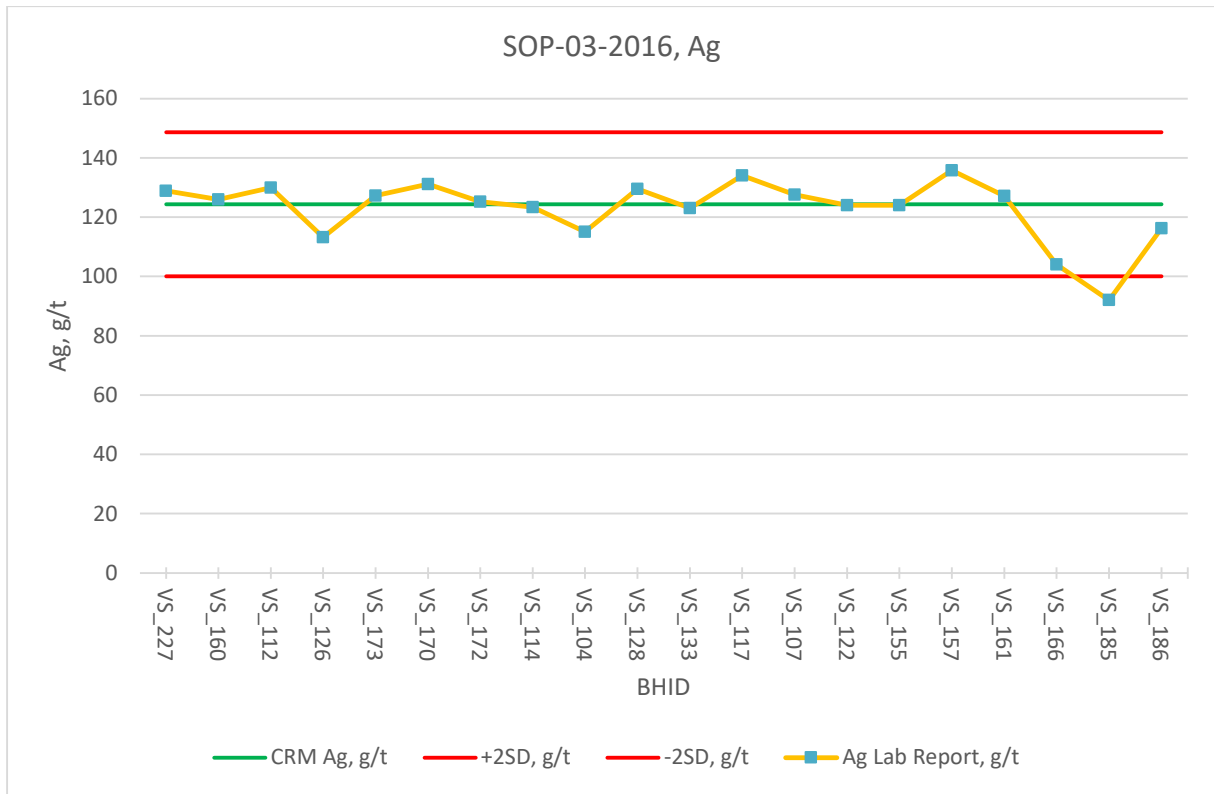


Figure 11.32: SOP-03-2016, Ag, CRM Assaying Results

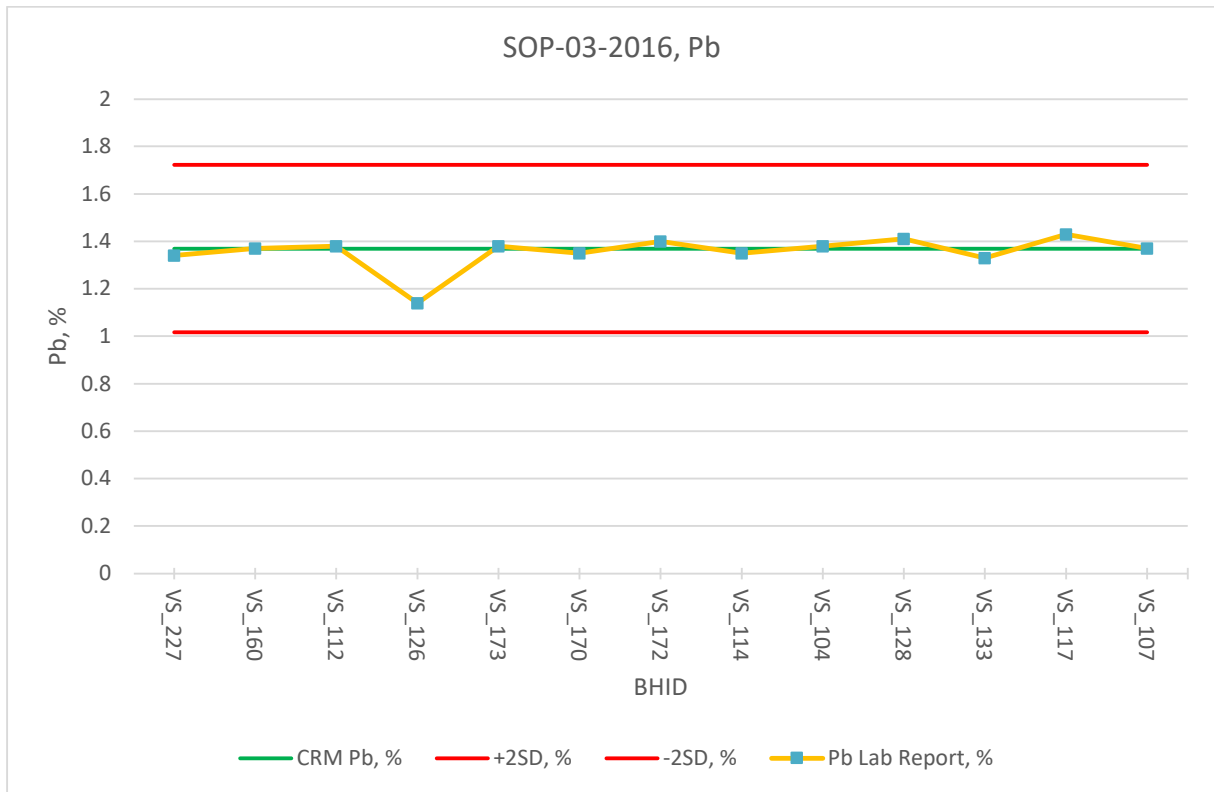
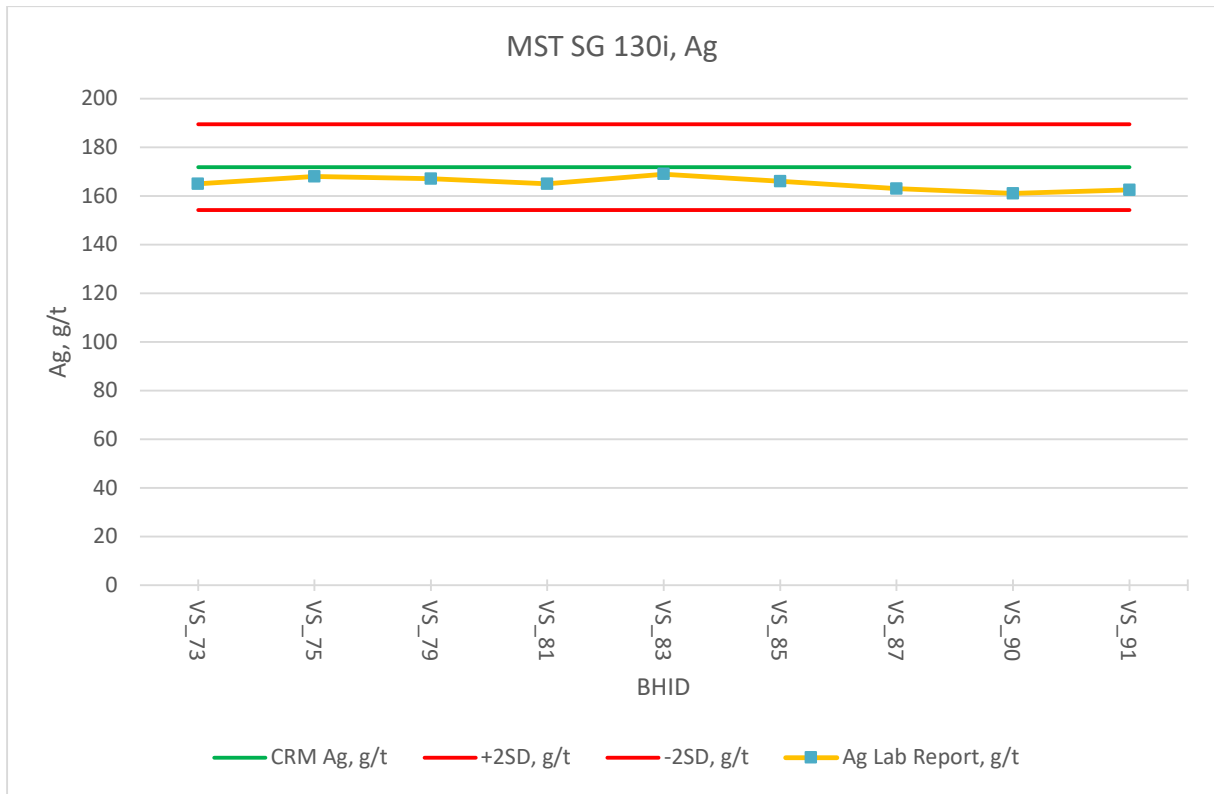
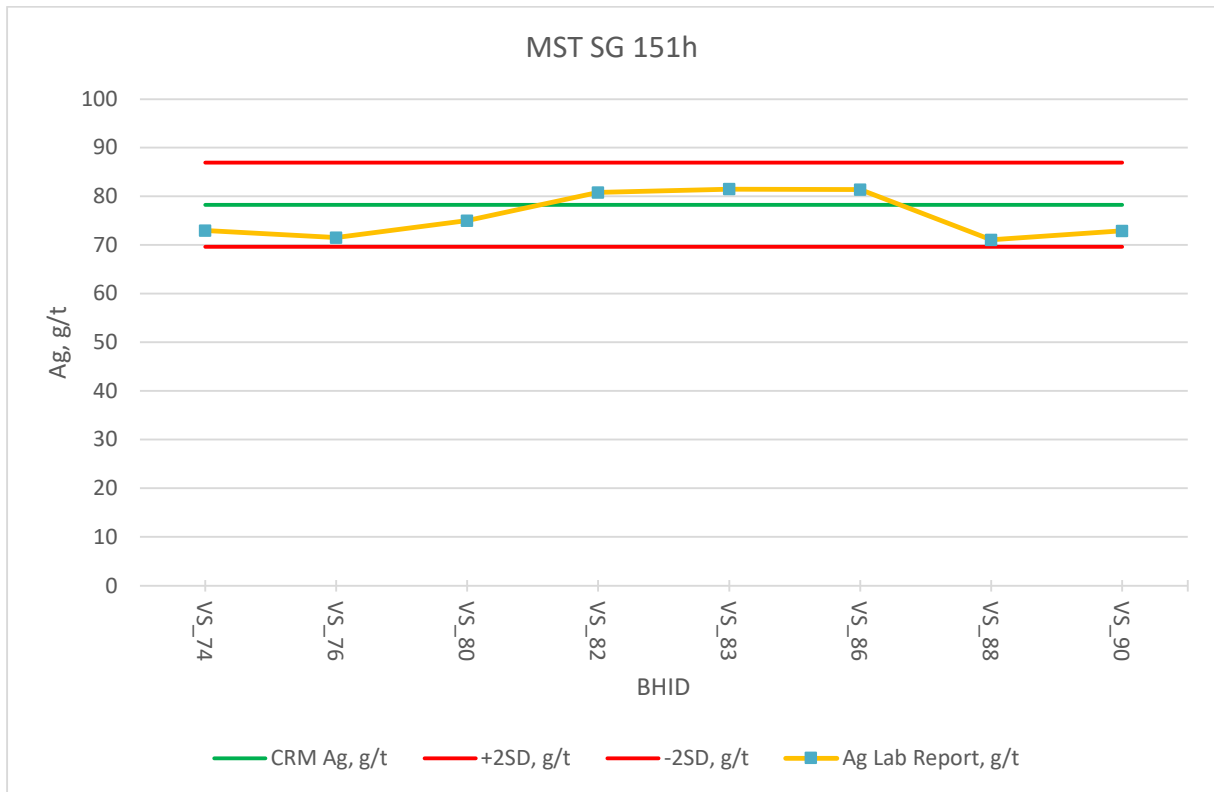


Figure 11.33: SOP-03-2016, Pb, CRM Assaying Results





**Figure 11.34: MST SG 130i, Ag, CRM Assaying Results**

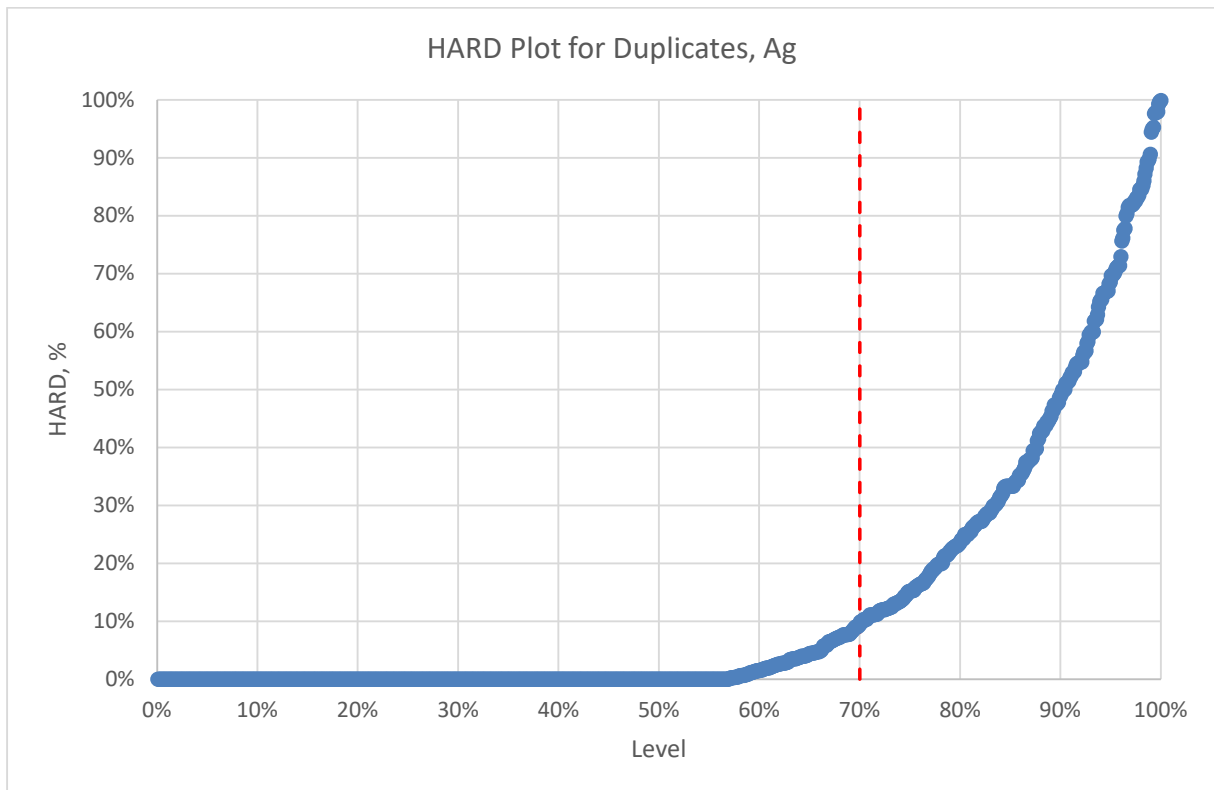


**Figure 11.35: MST SG 151h, Ag, CRM Assaying Results**

### 11.6.1.3 Field Duplicates

Data for 953 field duplicates representing second halves of core and/or additional/parallel channel samples from trenches were provided for the review. Initial grade for majority of samples (666) was less than 5g/t Ag.

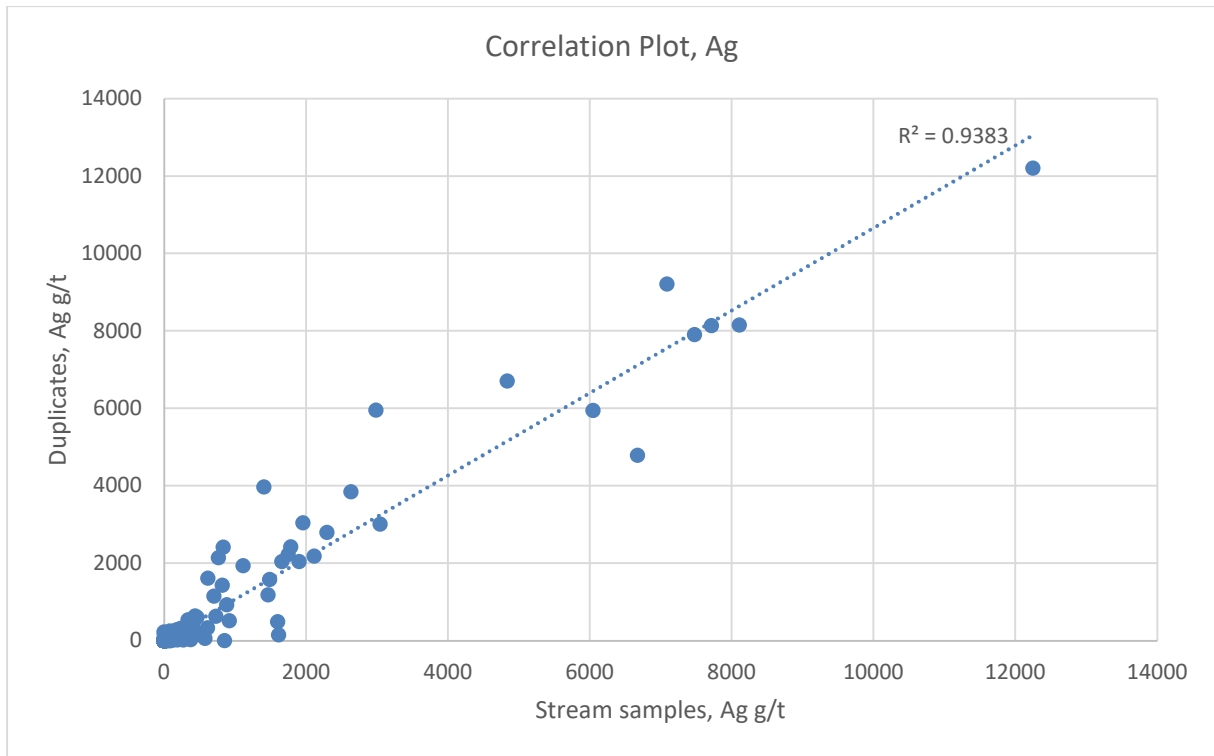
The data show that HARD value for 70% of duplicates is less than 10% that is satisfactory for precision of initial samples and their field duplicates (Figure 11.36).



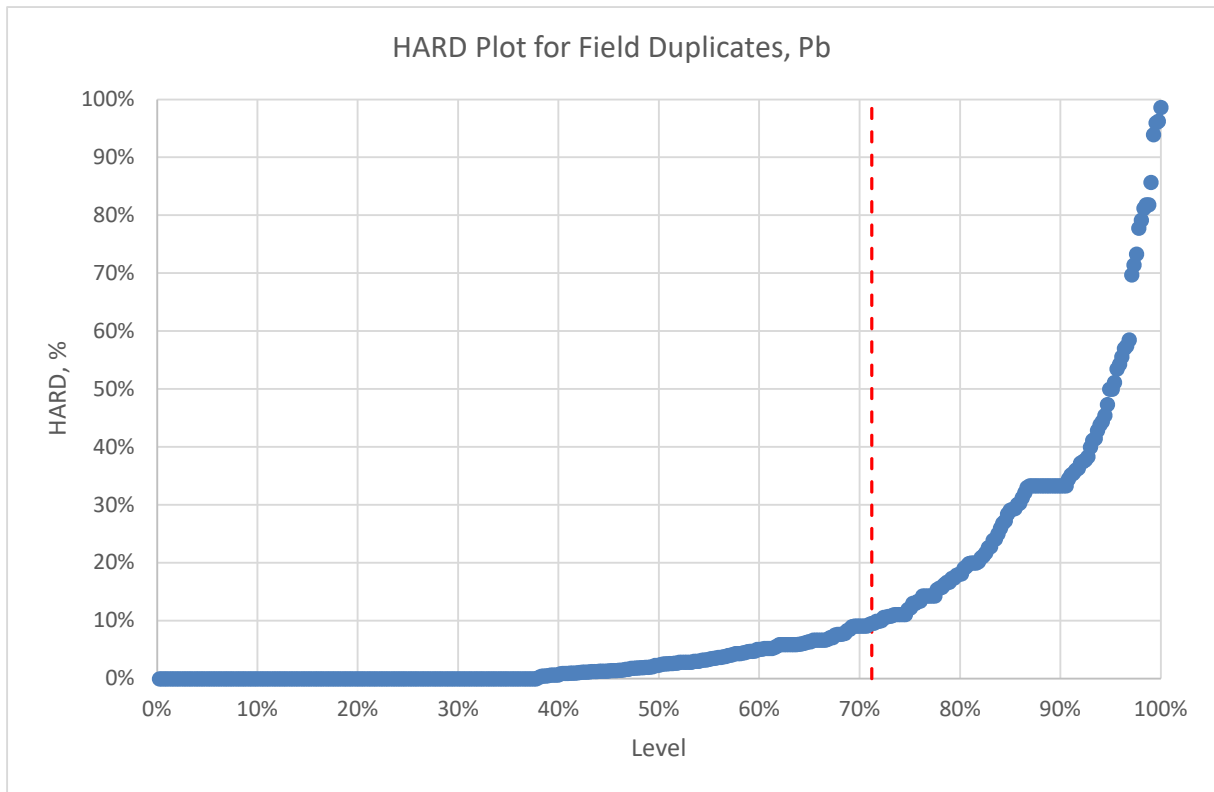
**Figure 11.36: HARD Plot for Field Duplicates, Ag**

Correlation plot for silver values in stream samples and their duplicates is shown in Figure 11.37.

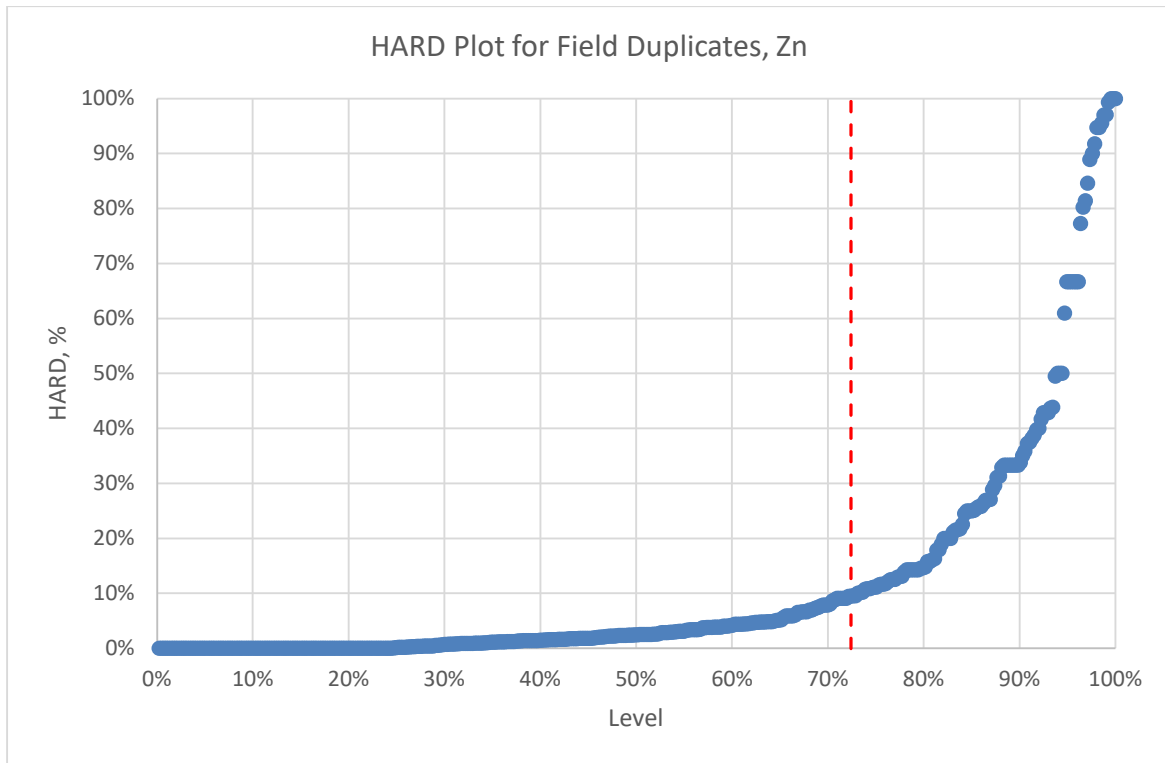
Data for Pb and Zn were provided for 414 pulp duplicates. HARD value is within 10% of precision level for 71.2% and 72.4% samples for lead and zinc respectively. HARD plots for these metals are represented in Figure 11.38 and Figure 11.39.



**Figure 11.37: Field Duplicates Correlation Plot, Ag**

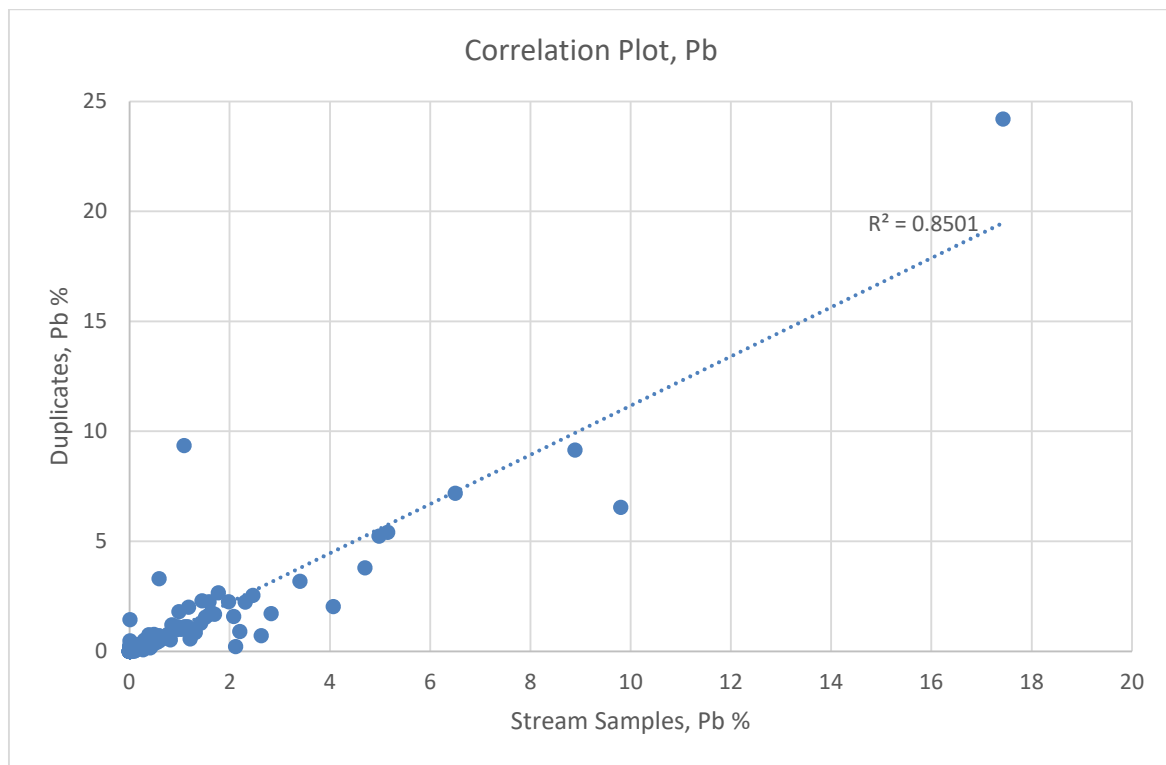


**Figure 11.38: HARD Plot for Field Duplicates, Pb**

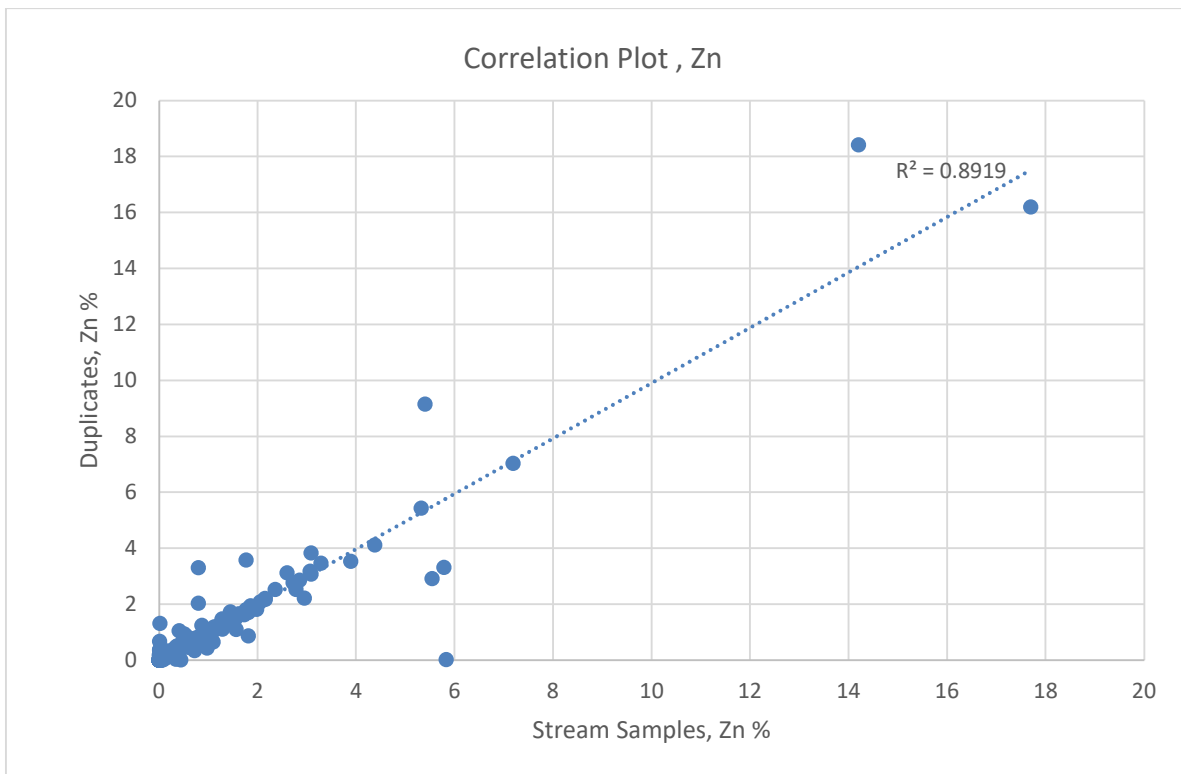


**Figure 11.39: HARD Plot for Field Duplicates, Zn**

Correlation plots for Pb and Zn for stream samples and duplicates are shown in Figure 11.40 and Figure 11.41.



**Figure 11.40: Correlation Plot for Field Duplicates, Pb**



**Figure 11.41: Correlation Plot for Field Duplicates, Zn**

### 11.6.2 Summary of QA/QC Risks

The WAI review of quality control data has identified a number of risks within the sample data. These risks are summarised in Table 11.4. It should be noted that Table 11.4 does not provide a quantitative risk assessment but gives an indication as to where WAI considers the risk lie within the sampling data.

A six-score classification has been employed where:

- 1 - 2 ('low' risk): Little or no perceived risk, or low uncertainty;
- 3 - 4 ('moderate' risk): Risk present which could lead to small material error in the resource model;
- 5 - 6 ('high' risk): This feature could lead to material error in the resource model (high uncertainty).

Sample Type	Risk	Comment
Blanks	5	Blanks assay results for Ag show possible contamination, elevated level of Ag mineralisation within the material, and some evidence of mislabeling. The Ag grade for 21 blank samples was greater than 50g/t. Zinc and lead blank assaying results are considered satisfactory.
CRMs	2	CRM assaying results for Ag are satisfactory, there are some insignificant deviations for Zn and Pb assaying results.
Field Duplicates	2	Precision based on HARD data is at an acceptable level, more than 70% of samples are below error limit of 10%.

Total risk related to the quality of sampling, sample preparation and assaying is considered to be 'moderate' - risk present which could lead to small material error in the resource model. Ultimately, the blank failures are not considered material to the Mineral Resource Estimate as the majority of the recorded values are significantly lower than any economic mineralisation. Notwithstanding, WAI would recommend that the QA/QC procedures to be improved by introduction of quartz sand flush into sample preparation protocol to mitigate the risk of sample contamination, review of blank sample material and possible change to an accredited blank sample material, and that database management and transcribing results are regularly monitored.

## 11.7 Quality Control Analysis – Mangazeisky North

### 11.7.1 Exploration 2009 – 2016.

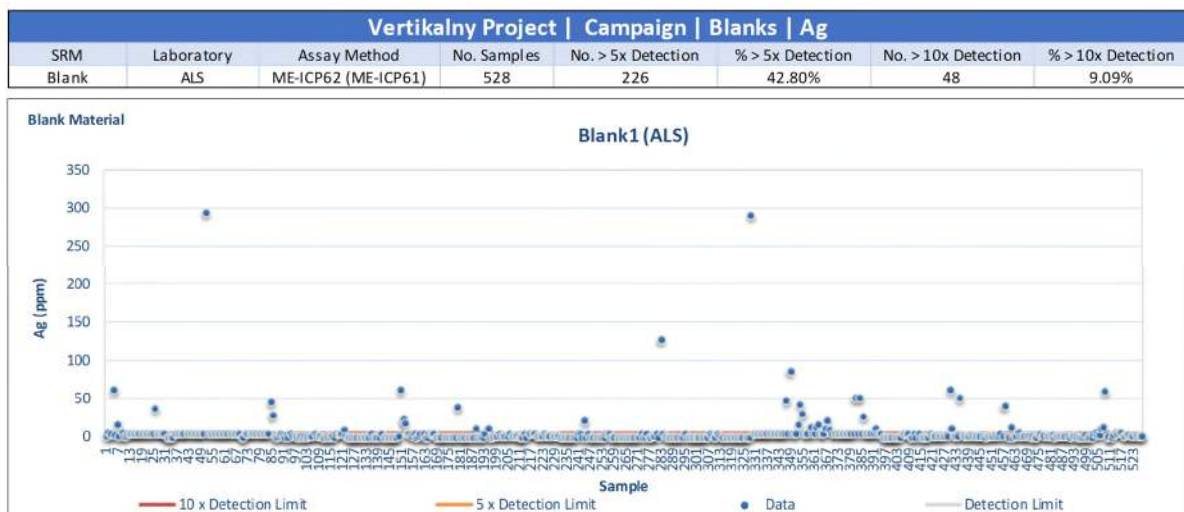
During exploration activities in 2009-2016 on Northern Mangazeisky blank samples and certified reference materials (CRM) were employed for QA/QC purposes, field duplicates of samples were used for internal control. Project geologists oversee the insertion of control samples into the sample stream. Field duplicates and blank samples were inserted before crushing, and CRMs were inserted after samples are ground, labelled and registered in a log.

At the time of this report a total of 3,446 samples (Table 11.5) have been analysed and provided for review and the quality control samples provided consist of analysis for 171 internal CRMs (4.9%), 159 field duplicate samples (4.6%), and 172 blank samples (5.0%).

Type of Control Sample	Total	With Assay Results		
		Ag	Pb	Zn
Stream Samples	3,446	3,443	2,826	3,163
Blank Samples	172	172	83	83
Field Duplicate Samples	159	159	120	148
CRMs	171	171	159	160

### 11.7.1.1 Blanks

As for Vertikalny, a local source of siltstone (aleurolite) was used for blank sample material. A total of 528 blank samples were available for review. It is clear from the results that different detection limits have applied depending on the laboratory and analysis method. For the purpose of this assessment, WAI has selected 0.5ppm as the minimum detection limit. The results of the blank analysis for Ag are shown in Figure 11.42 showing a total of 226 out of 528 blanks samples were found to exceed the 5x detection limit (2.5ppm), and 48 exceeding 10x detection limit (5ppm). However, by applying a detection limit of 5ppm, only 20 samples are >5x detection limit and 11 are >10 detection limit. A total of 11 'blank' samples are >50ppm.



**Figure 11.42: Blank Samples Analysed for Ag on North Mangazeisky**

Pb and Zn were detected in 83 blank samples. Out of them 22 samples returned Pb grade that was twice the accepted detection limit (0.02% Pb), and only 16 samples out of these 55 had Pb grade >0.25%. The results of blank samples analysis for Pb are presented in Figure 11.43

In assays for Zn, 5 sampled returned Zn grade that was twice the accepted detection limit (0.02%Zn), 1 sample out of them had Zn grade >0.25%. The results of blank samples analysis for Zn are presented in Figure 11.44.

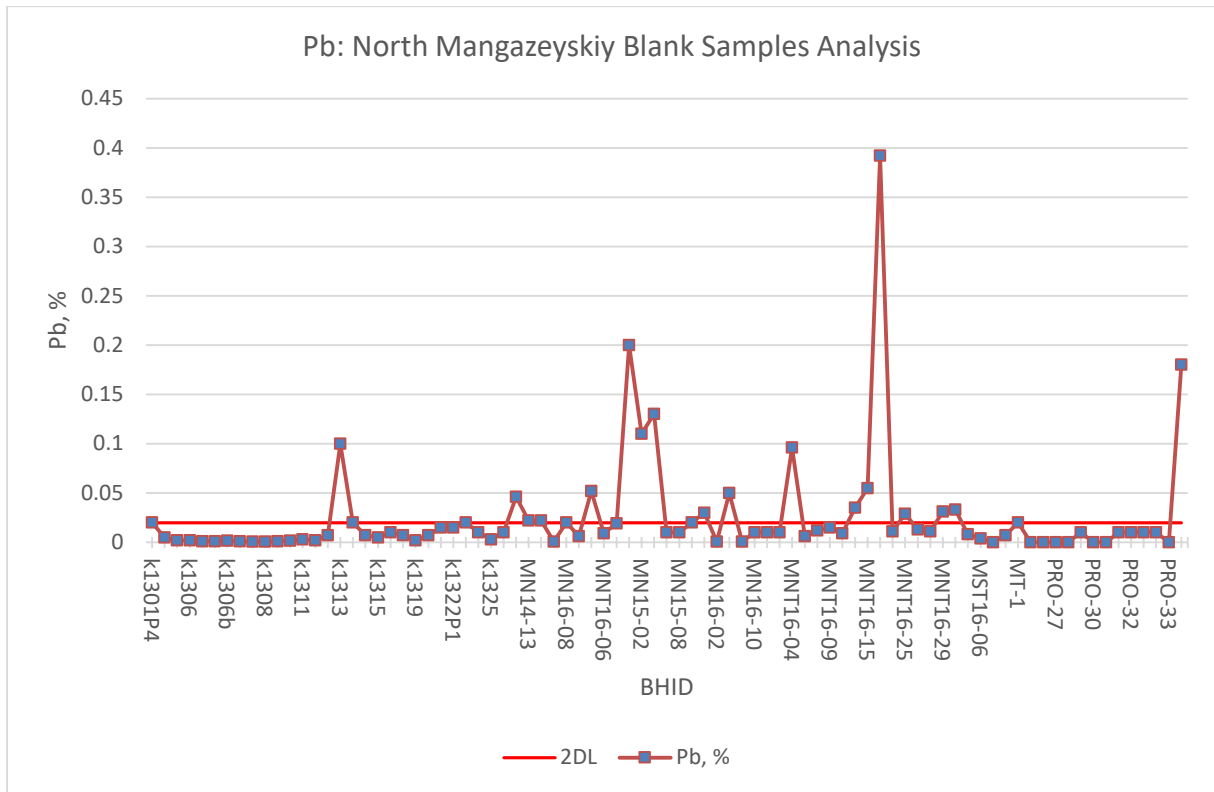


Figure 11.43: Blank Samples Analysed for Pb on North Mangazeyskiy

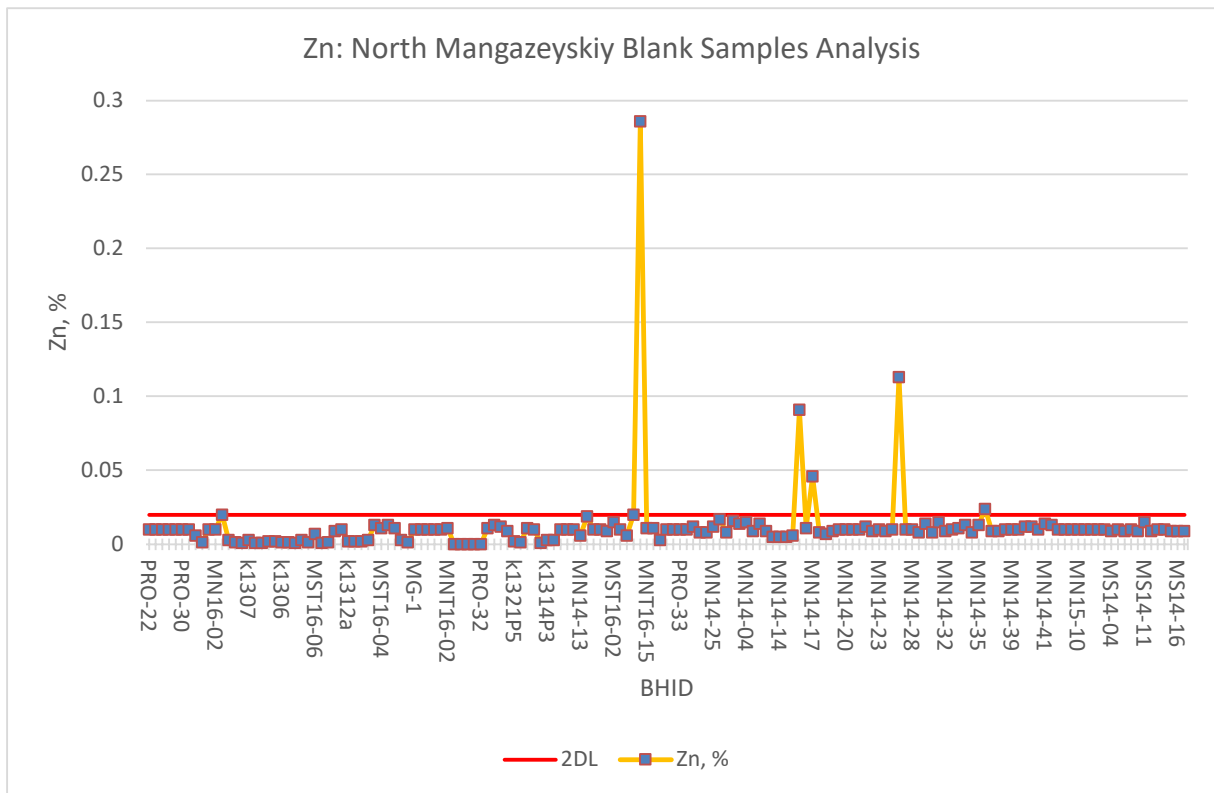


Figure 11.44: Blank Samples Analysed for Zn on North Mangazeyskiy



In general, the blank performance was found to be acceptable. Failures may be due to minor mineralisation within the blank material, rather than poor practice and do not represent material risk to the Project. Notwithstanding, WAI recommends that a true blank material be introduced to mitigate the failure rate and that additional checks are conducted into the analysis method, and detection limit, along with database management.

#### 11.7.1.2 Certified Reference Materials (CRM)

Ten certified reference materials (CRMs) sourced from GEOSTATS Pty Ltd (Australia), STC Minstandard of St Petersburg, and Irgiredmet OJSC of Irkutsk (Table 11.6).

No	CRM	Manufacturer
1	GBM 906-6	GEOSTATS Pty Ltd, Australia
2	GBM 908-8	
3	GBM 913-13	
4	GBM310-16	
5	GBM909-11	
6	GBM913-13	
7	СОП 01-2016 (SOP 01-2016)	Irgiredmet OJSC
8	СОП 02-2016 (SOP 02-2016)	
9	СОП 03-2016 (SOP 03-2016)	
10	MST SG 186	

The recommended values and number of assays for each CRM are listed in Table 11.7. Laboratory certificates have been provided for all but one of the CRMs. CRM limits are provided as permitted allowed absolute error (based on >95% of samples being within that target) rather than the more usual standard deviation limits.

In general, a good precision of the results of laboratory assays for Ag and certified values was noted. The highest deviations are typical for CRMs with low Ag grades (<5g/t) that are close to the assays' detection limits.

The majority of assay results beyond allowed error limits with meaningful zinc contents were shown for GBM 310-16 and GBM 909-13 CRMs generally returning lower Zn grades in comparison with CRMs.

Despite of this, risk for MRE might be considered as insignificant.

**Table 11.7: Summary of CRMs Data for North Mangazeyskiy**

CRM	Metal, Unit	Grade	Standard Deviation	Expanded Uncertainty	Number of CRMs	Beyond Allowed Absolute Error	% of Satisfactory Assays
GBM906-6	Ag, g/t	389.7	21.1		57	1	98.2%
	Zn, g/t	210	14		57	20	64.9%
	Pb, g/t	290	14		57	20	64.9%
GBM908-8	Ag, g/t	12	-		92	-	-
GBM913-13	Ag, g/t	74,1	3.9		16	0	100.0%
GBM310-16	Ag, g/t	314.3	14.9		32	5	84.4%
	Zn, g/t	170,201	6,825		31	5	83.9%
	Pb, g/t	112,603	5,008		32	23	28.1%
GBM909-11	Ag, g/t	25.5	1.7		9	0	100.0%
GBM909-13	Ag, g/t	127.3	6.8		32	0	100.0%
	Zn, g/t	68,362	2363		32	16	50.0%
	Pb, g/t	8,513	327		26	17	34.6%
СОП 01-2016 (SOP 01-2016)	Ag, g/t	3.21		+/- 0.28	7	3	57.1%
	Zn, %	0.129		+/- 0.007	6	1	83.3%
	Pb, %	0.083		+/- 0.004	6	1	83.3%
СОП 02-2016 (SOP 02-2016)	Ag, g/t	73.7		+/- 3.2	6	0	100.0%
	Zn, %	0.86		+/- 0.02	3	0	100.0%
	Pb, %	2.45		+/-0.09	3	0	100.0%
СОП 03-2016 (SOP 03-2016)	Ag, g/t	124.4		+/- 6.2	3	0	100.0%
MST SG 186	Ag, g/t	36		n/d	32		
	Zn, %	0.0053		n/d	10		
	Pb, %	0.035		n/d	10		

There are no data on allowed absolute error for MST SG 186 (6 samples) therefore results for these CRMs were not considered. The results of CRMs analyses are illustrated on Figure 11.45 to Figure 11.62.

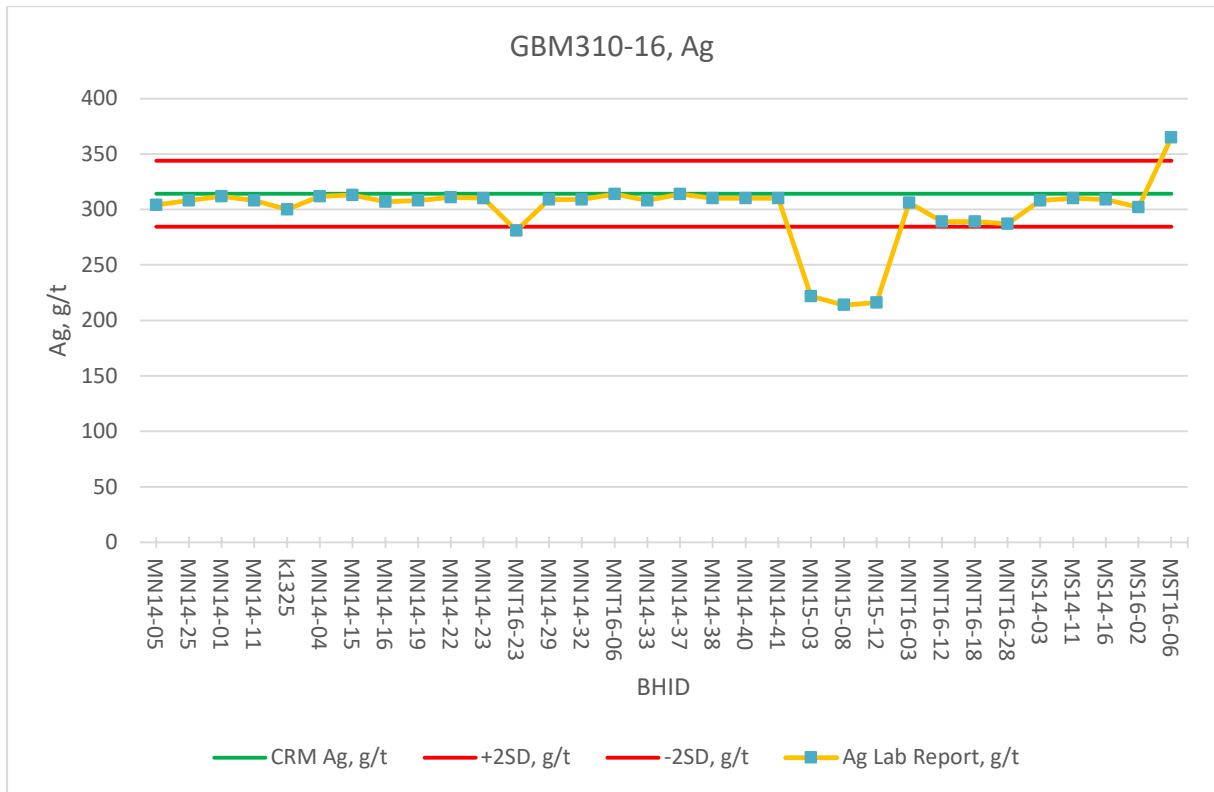


Figure 11.45: GBM 310-16, Ag, CRM Assaying Results

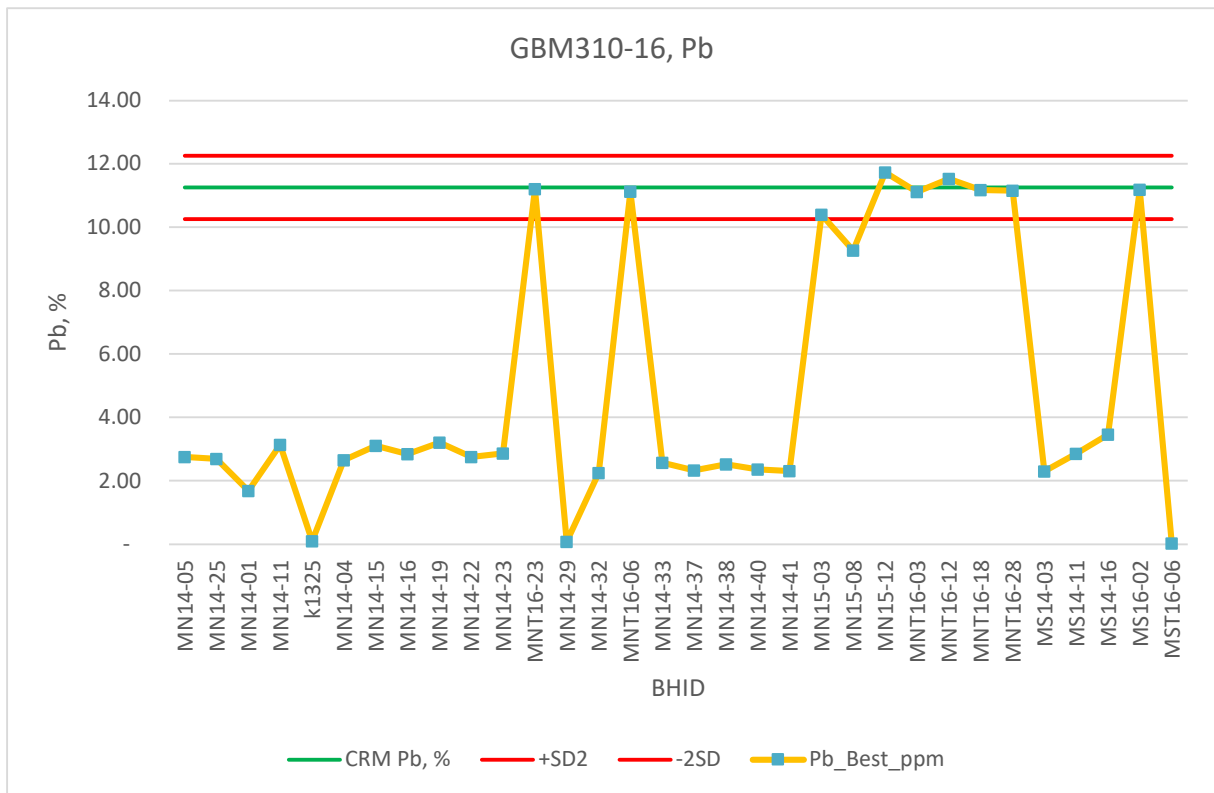


Figure 11.46: GBM 310-16, Pb, CRM Assaying Results

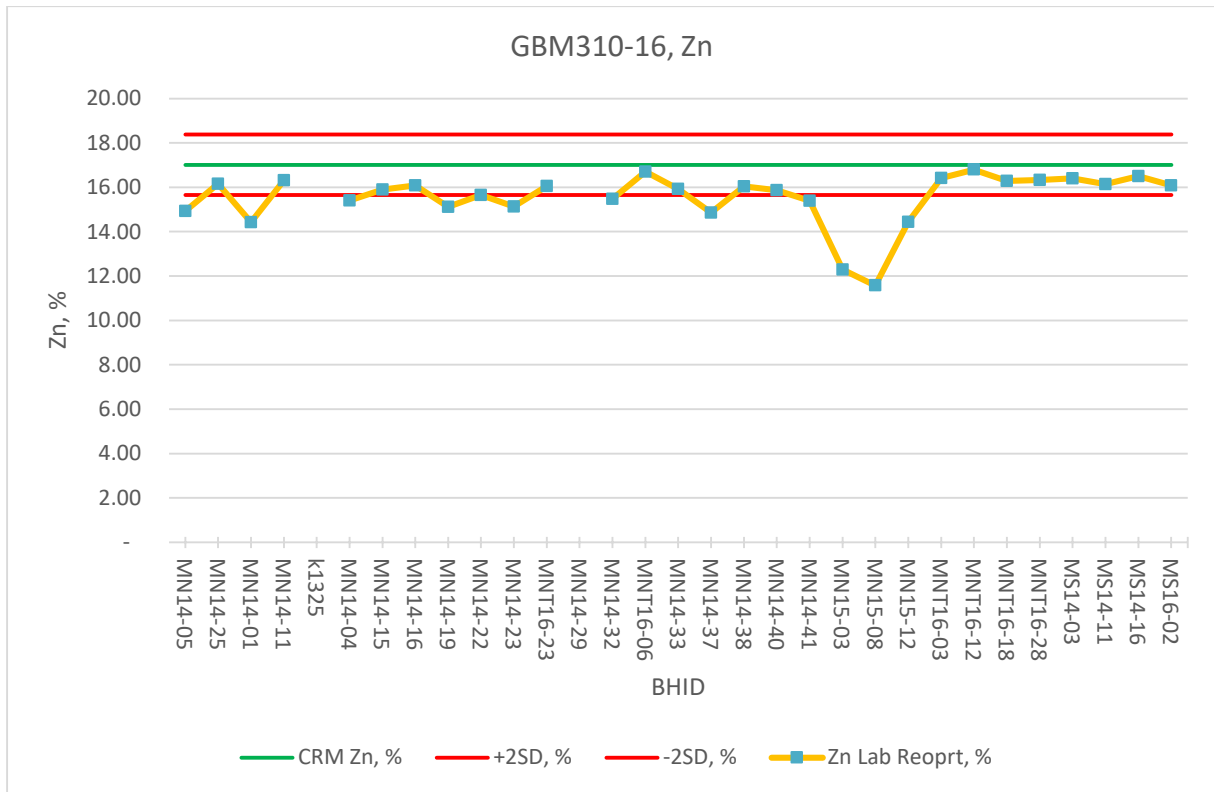


Figure 11.47: GBM 310-16, Zn, CRM Assaying Results

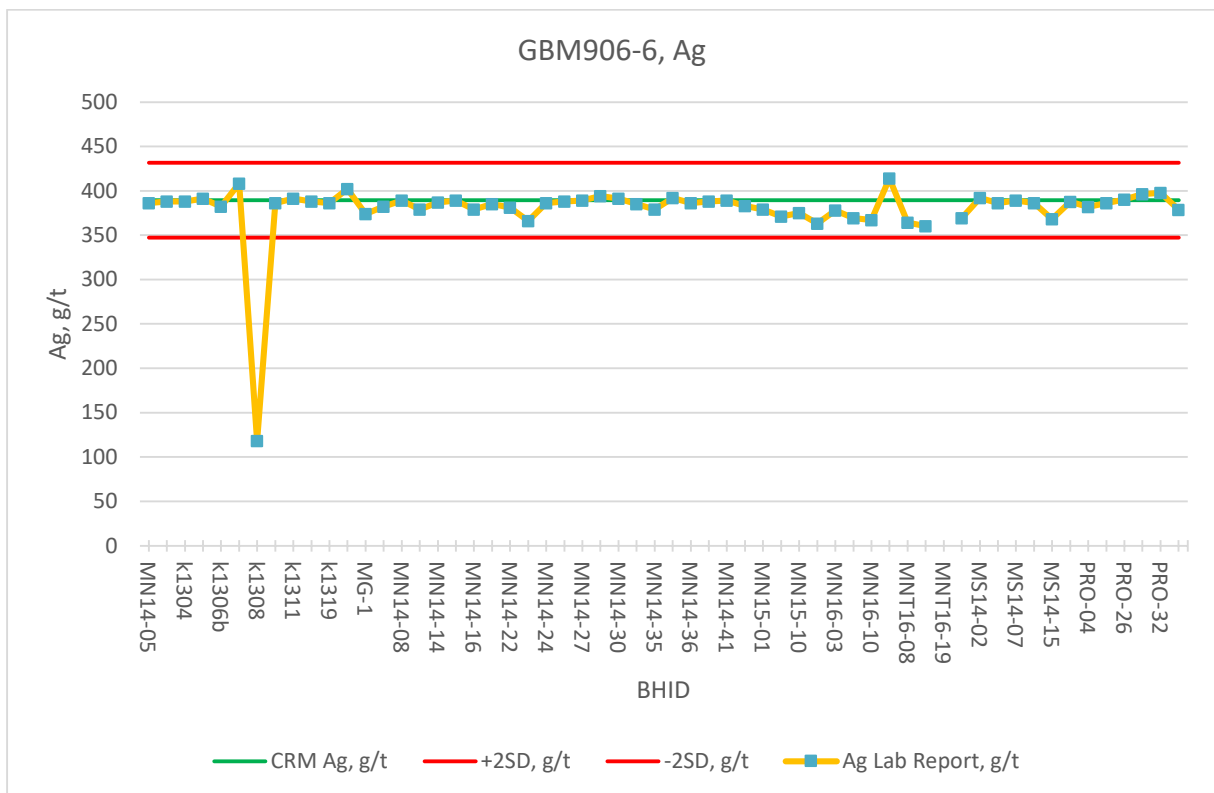


Figure 11.48: GBM 906-6, Ag, CRM Assaying Results

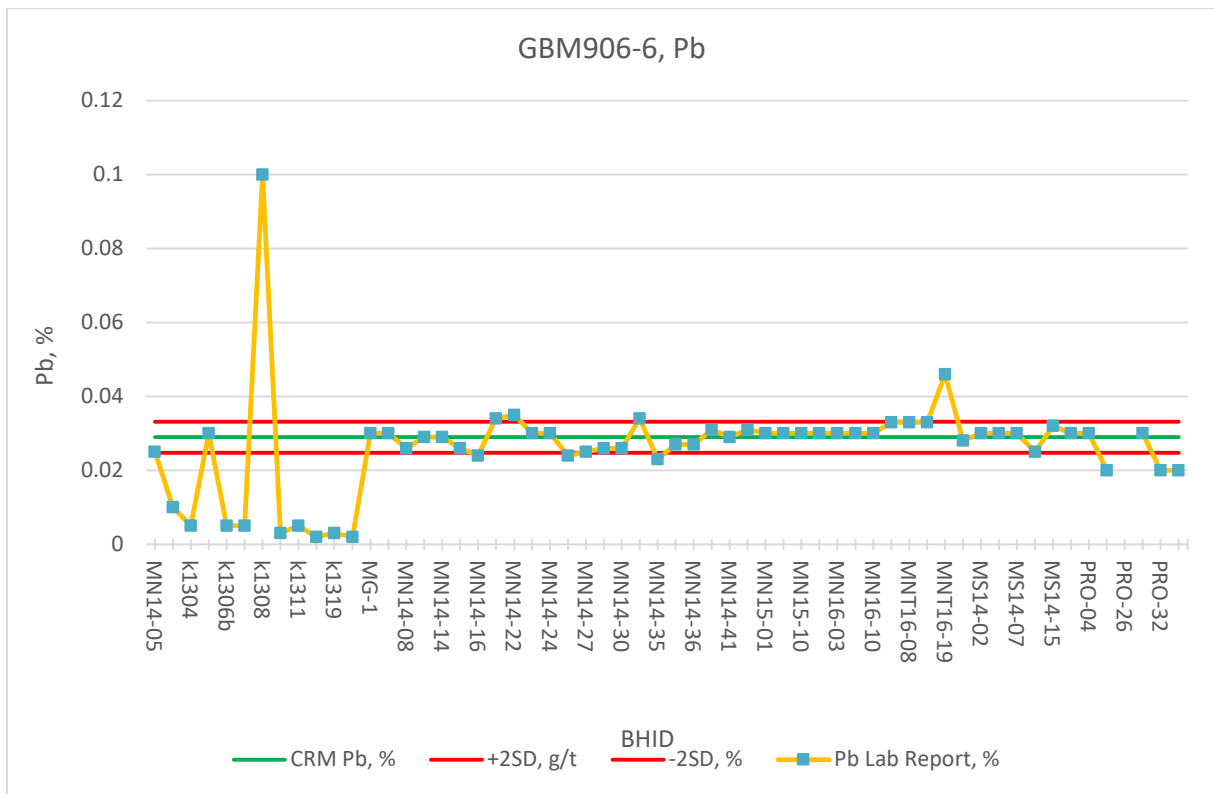


Figure 11.49: GBM 906-6, Pb, CRM Assaying Results

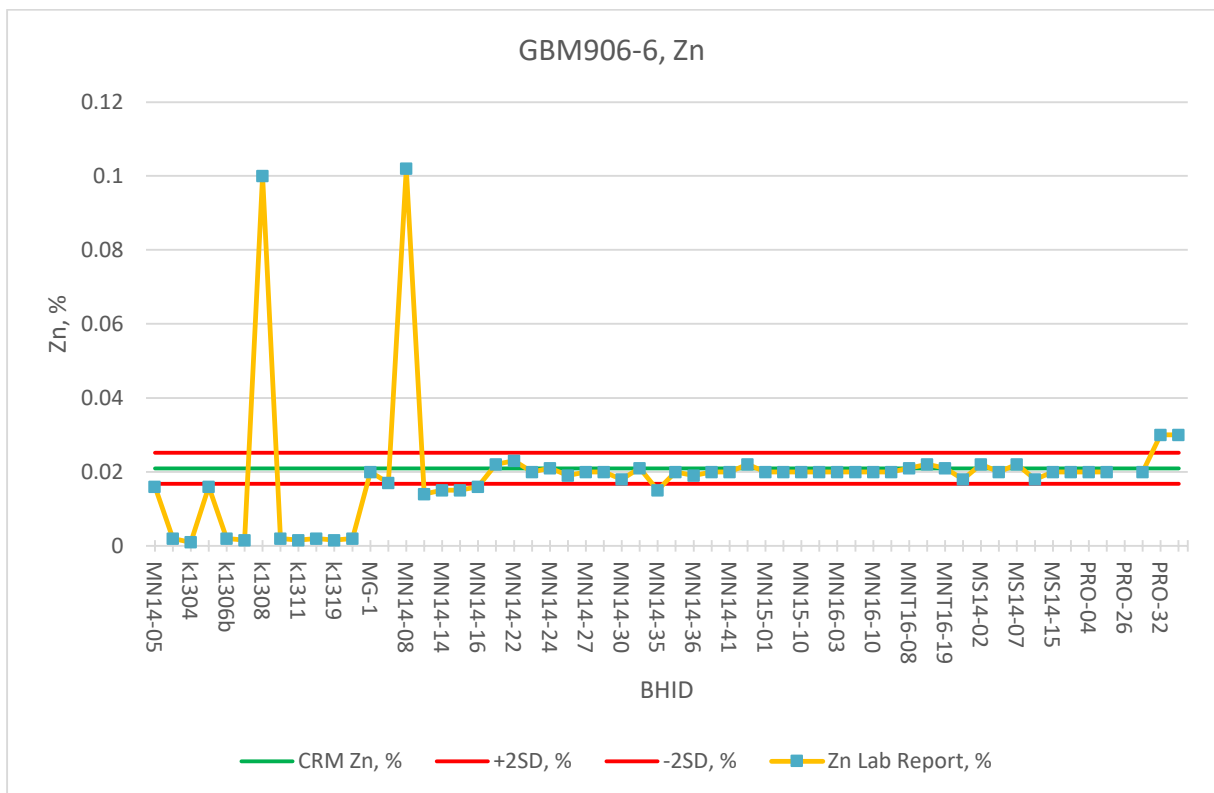
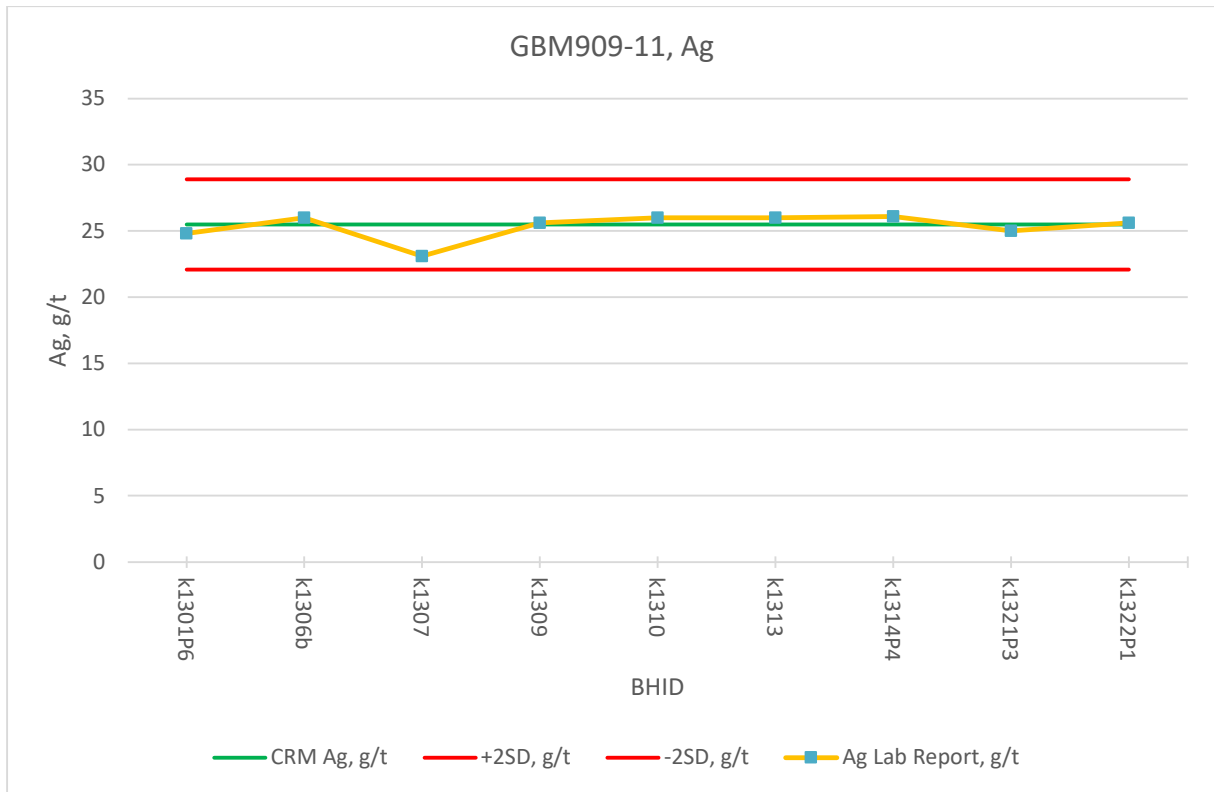
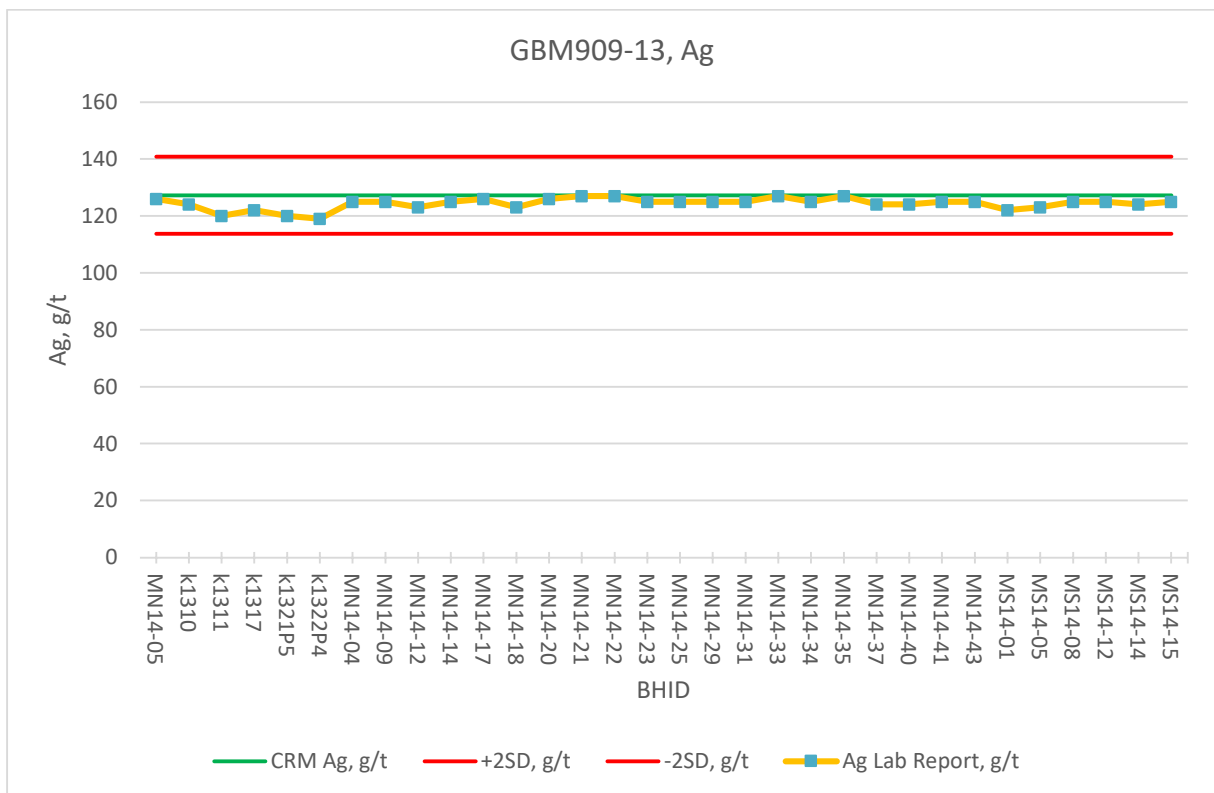


Figure 11.50: GBM 906-6, Zn, CRM Assaying Results



**Figure 11.51: GBM 909-11, Ag, CRM Assaying Results**



**Figure 11.52: GBM 909-13, Ag, CRM Assaying Results**

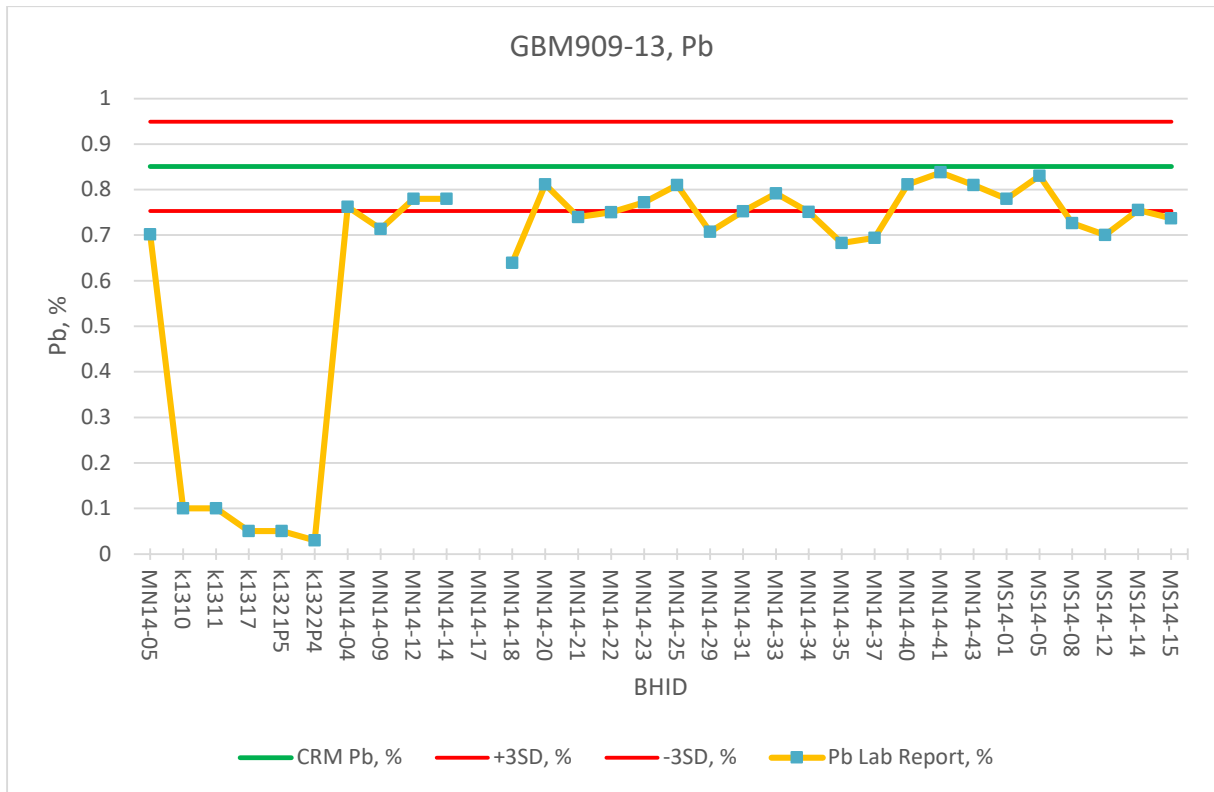


Figure 11.53: GBM 909-13, Pb, CRM Assaying Results

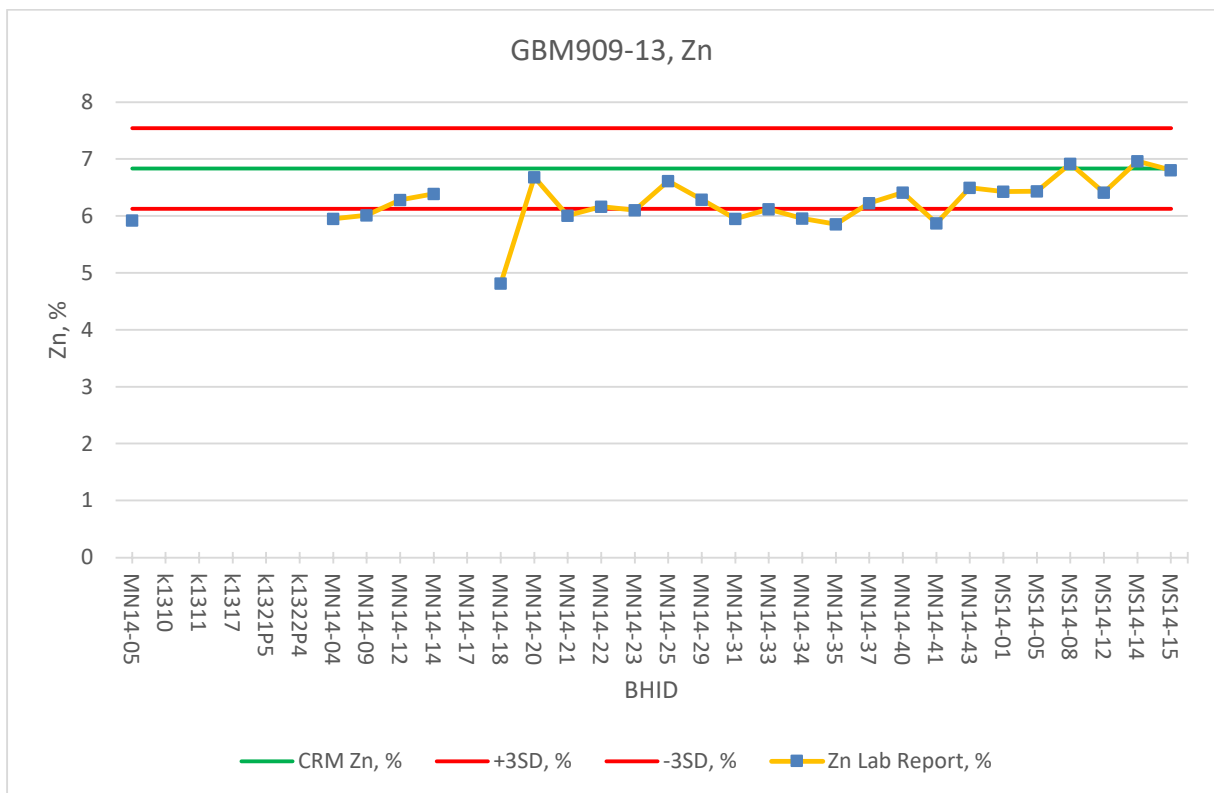
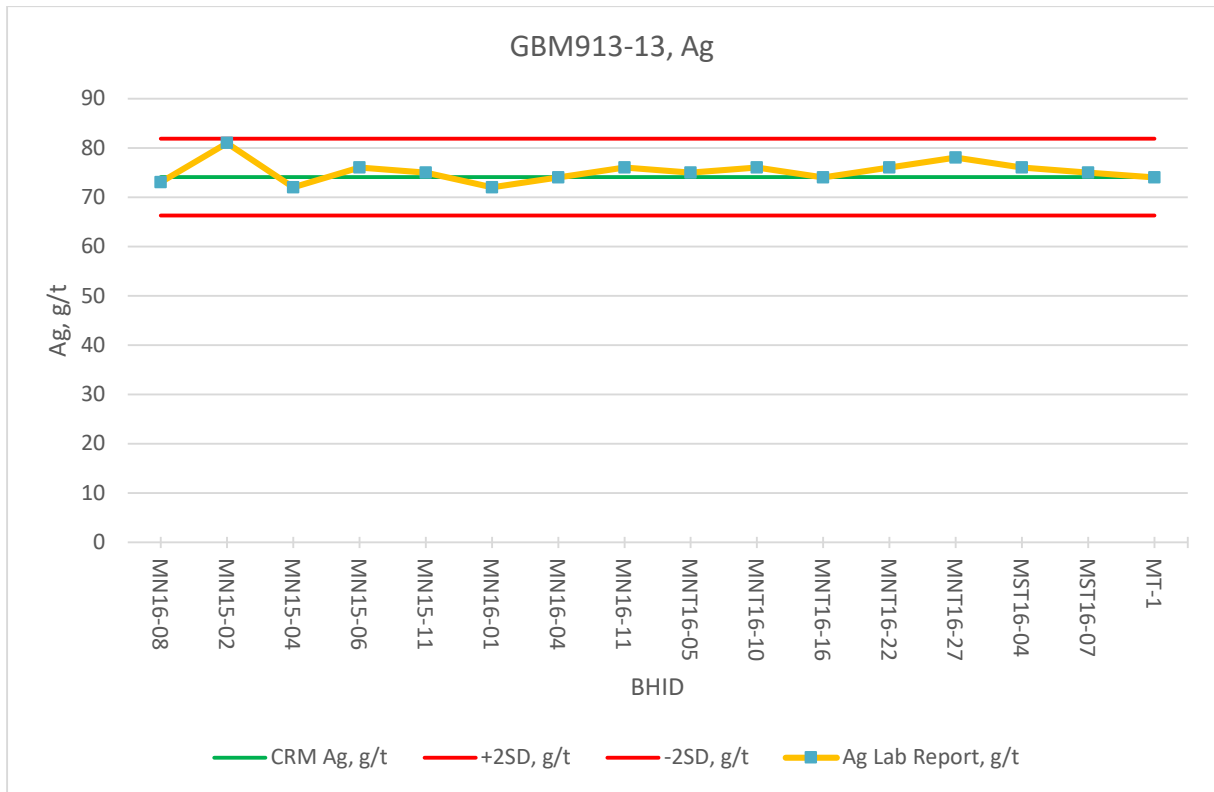
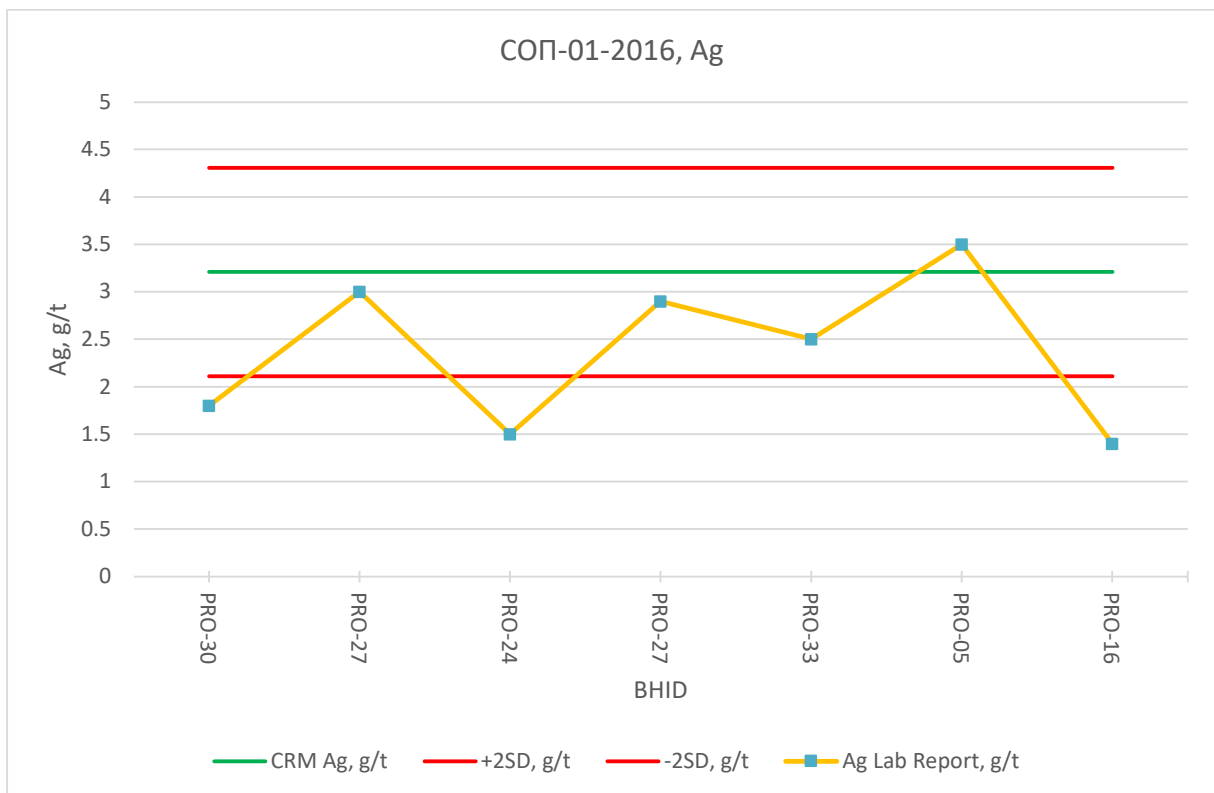


Figure 11.54: GBM 909-13, Zn, CRM Assaying Results

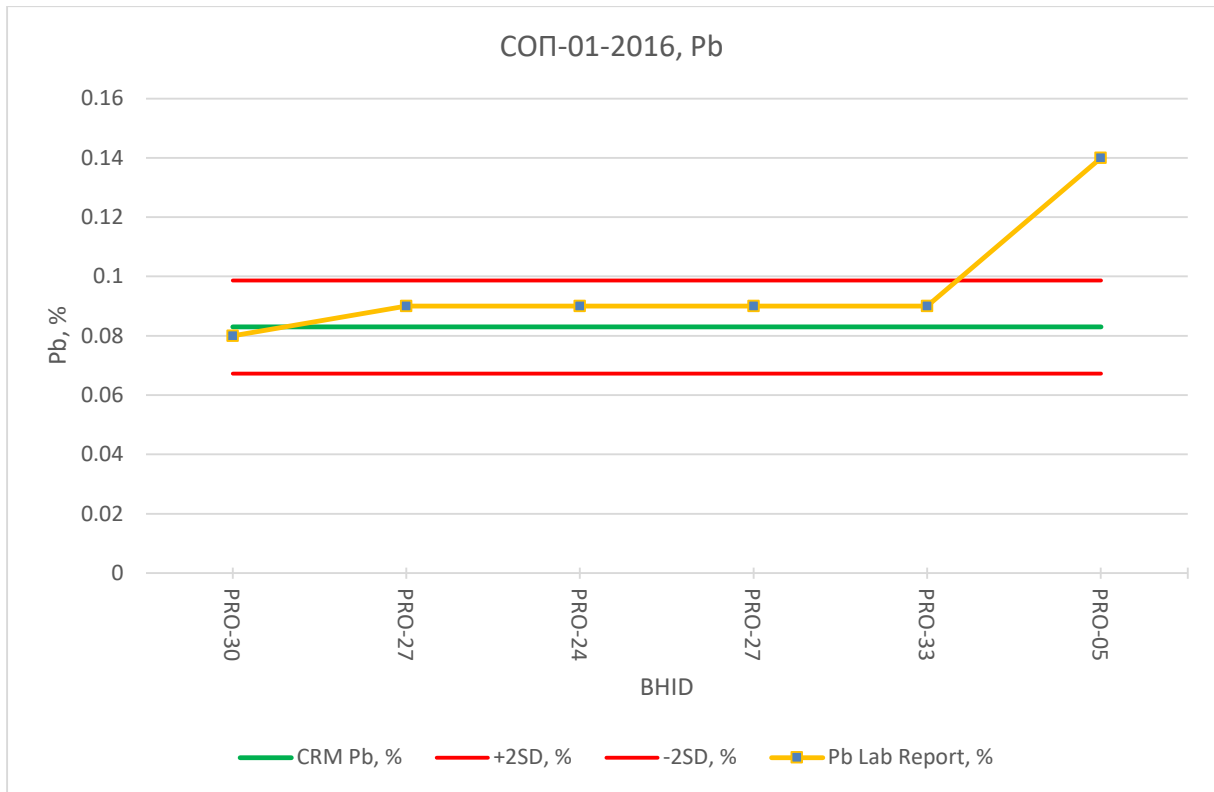


**Figure 11.55: GBM 913-13, Ag, CRM Assaying Results**

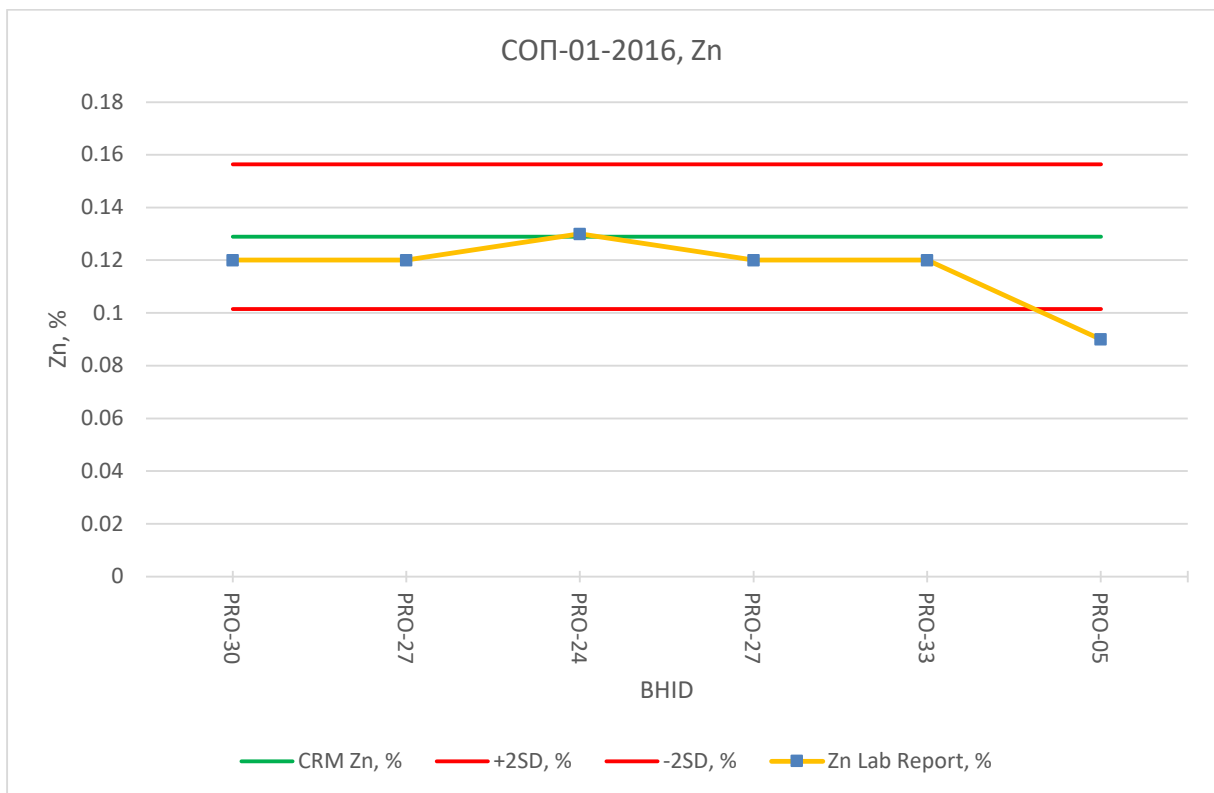


**Figure 11.56: SOP-01-2016, Ag, CRM Assaying Results**

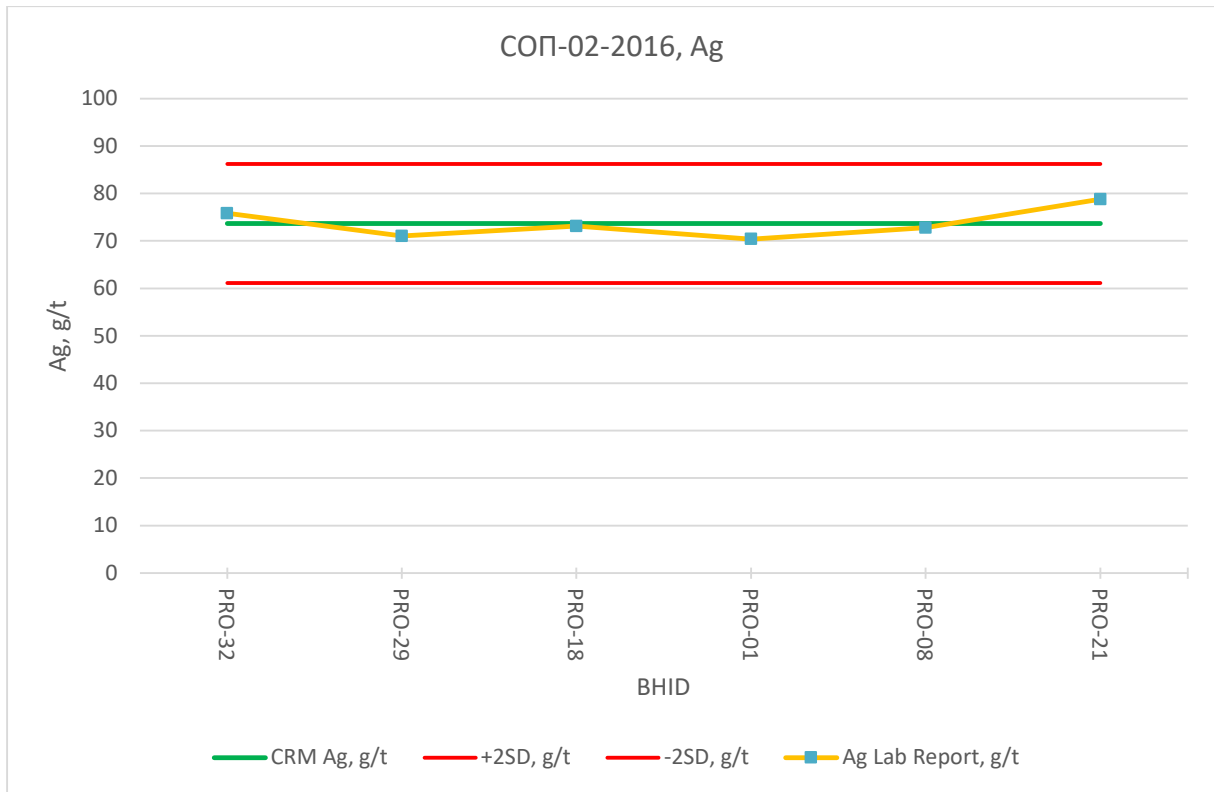




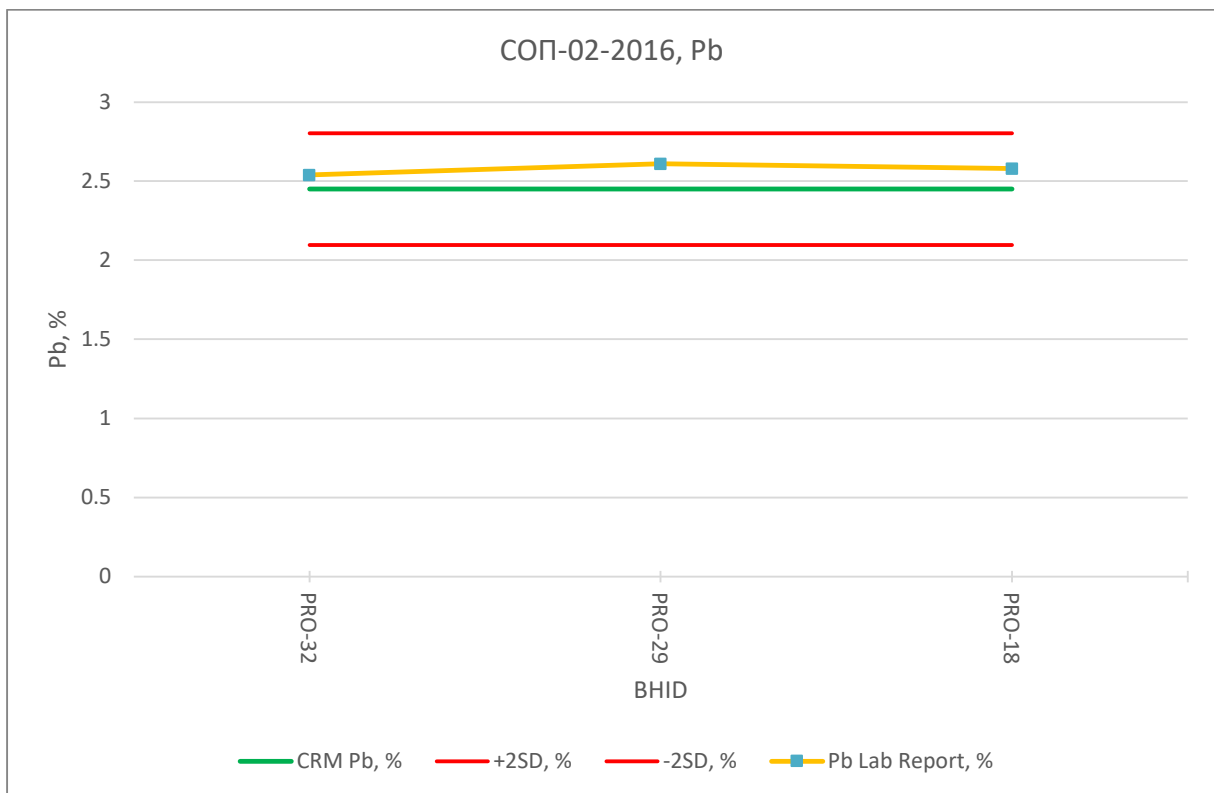
**Figure 11.57: SOP-01-2016, Pb, CRM Assaying Results**



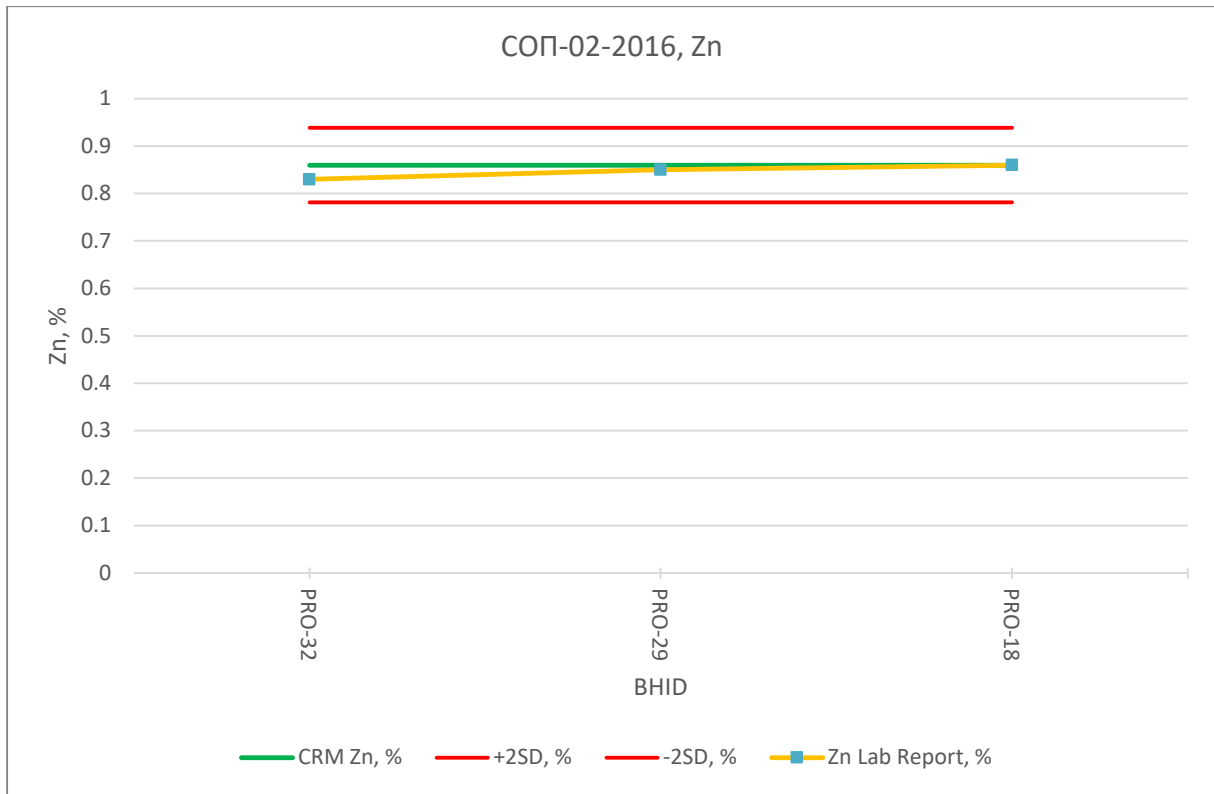
**Figure 11.58: SOP-01-2016, Zn, CRM Assaying Results**



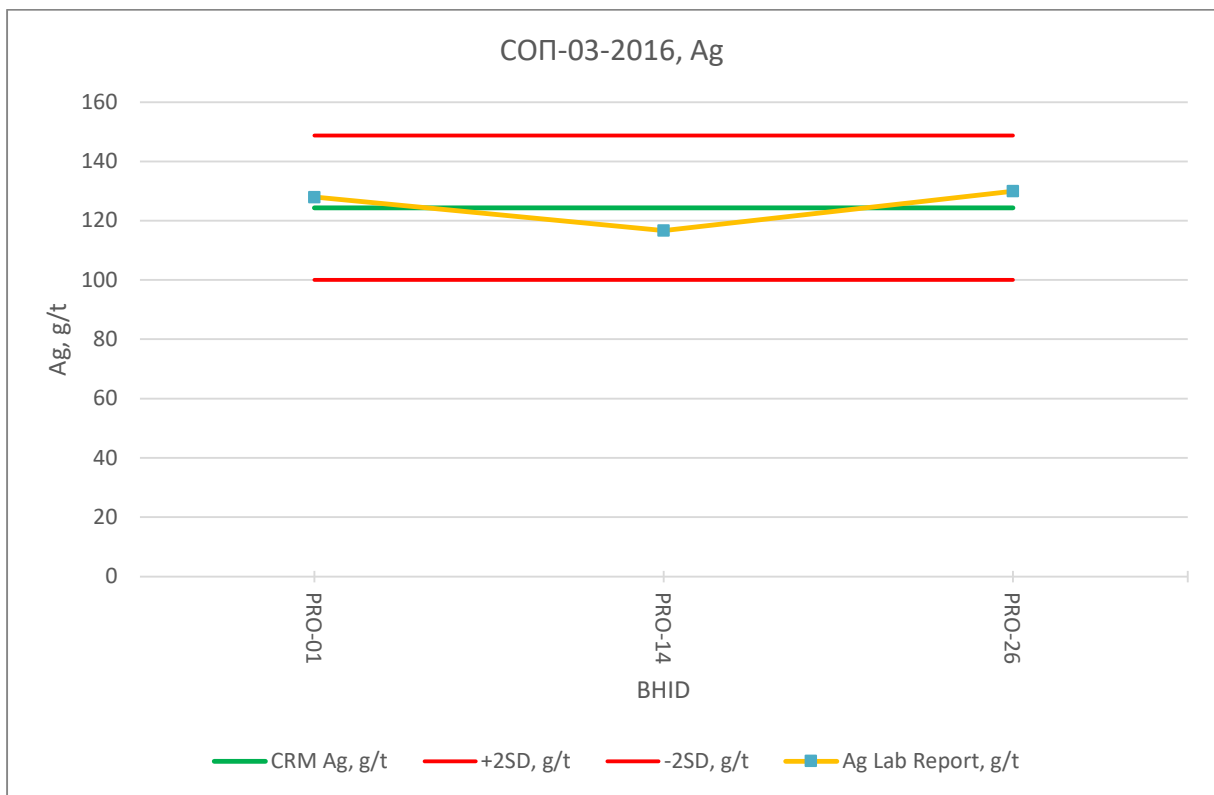
**Figure 11.59: SOP-02-2016, Ag, CRM Assaying Results**



**Figure 11.60: SOP-02-2016, Pb, CRM Assaying Results**



**Figure 11.61: SOP-02-2016, Zn, CRM Assaying Results**



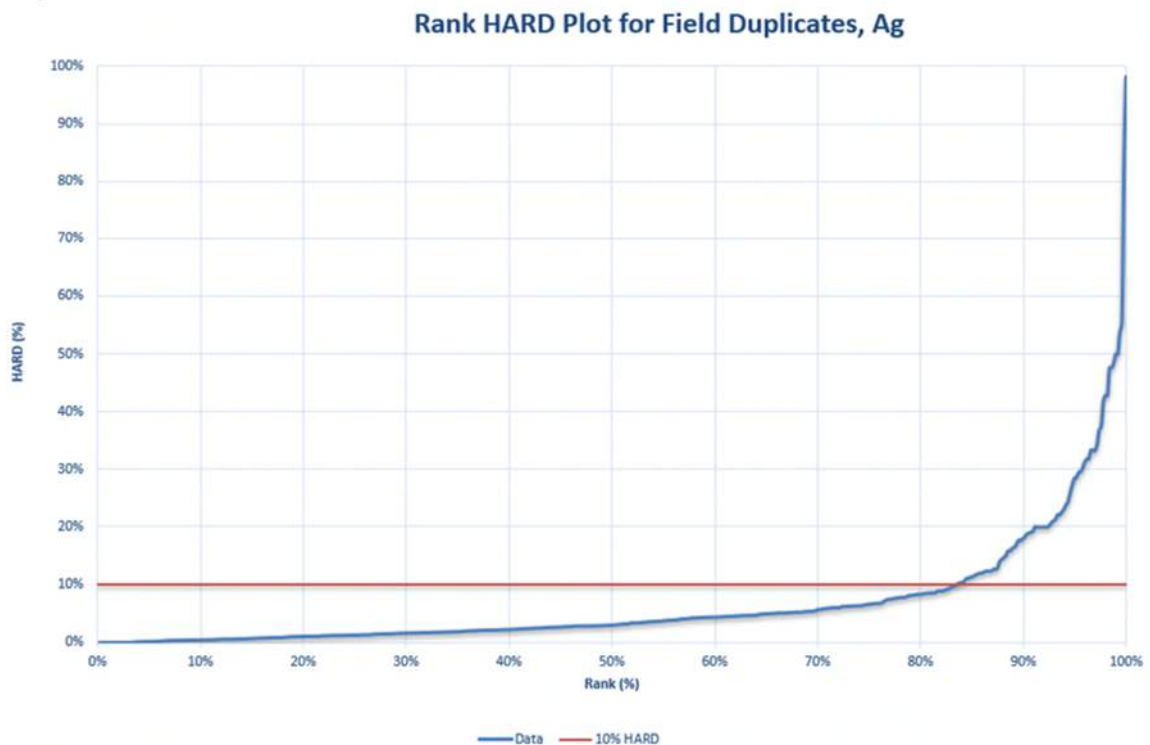
**Figure 11.62: SOP-03-2016, Ag, CRM Assaying Results**

### 11.7.1.3 Field Duplicates

A total of 496 duplicate half core samples were available for the Mangazeisky project. A good correlation was seen between primary and half core samples. However, most of the samples are of low grade, with a mean value of 3.53g/t and 3.50g/t for primary and duplicate samples respectively.

The data show that HARD value for >83% of duplicates are less than 10% HARD criteria, which is considered as satisfactory for precision of primary samples and their field duplicates (Figure 11.63).

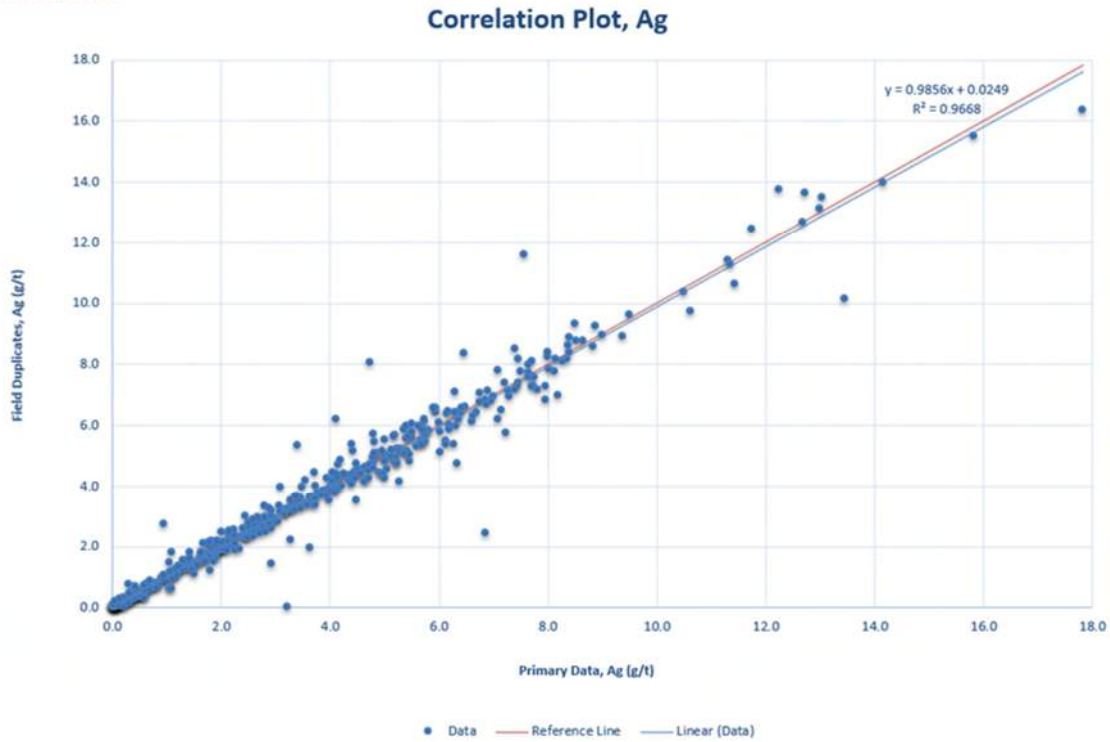
#### Field Duplicates



**Figure 11.63: HARD Plot for Field Duplicates, Ag**

Correlation plot for silver values in stream samples and their duplicates is shown in Figure 11.64.

Field Duplicates



**Figure 11.64: Primary vs Half Core Field Duplicates Correlation Plot, Ag**

Data for Pb and Zn were provided for 120 and 148 field duplicates, respectively. HARD value is within 10% of precision level for 73.3% and 77.7% samples for lead and zinc respectively. HARD plots for these metals are represented in Figure 11.65 and Figure 11.66.

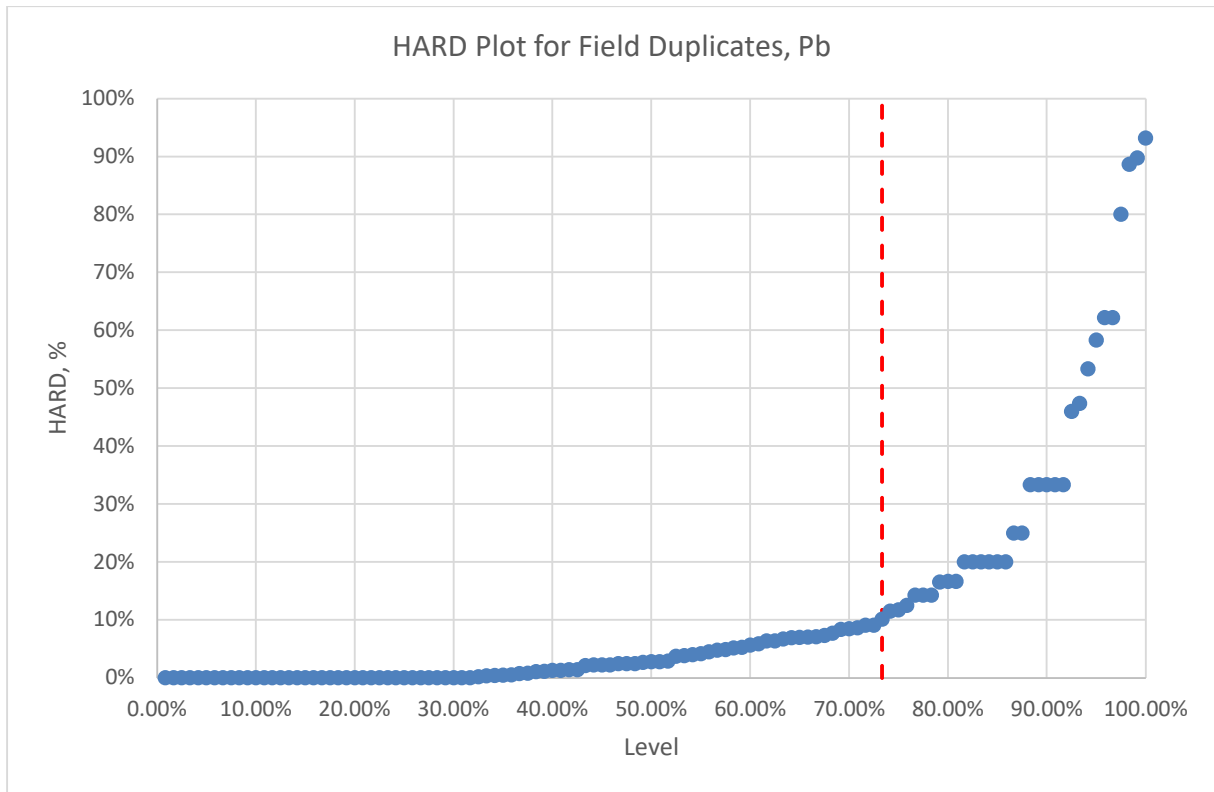


Figure 11.65: HARD Plot for Field Duplicates, Pb

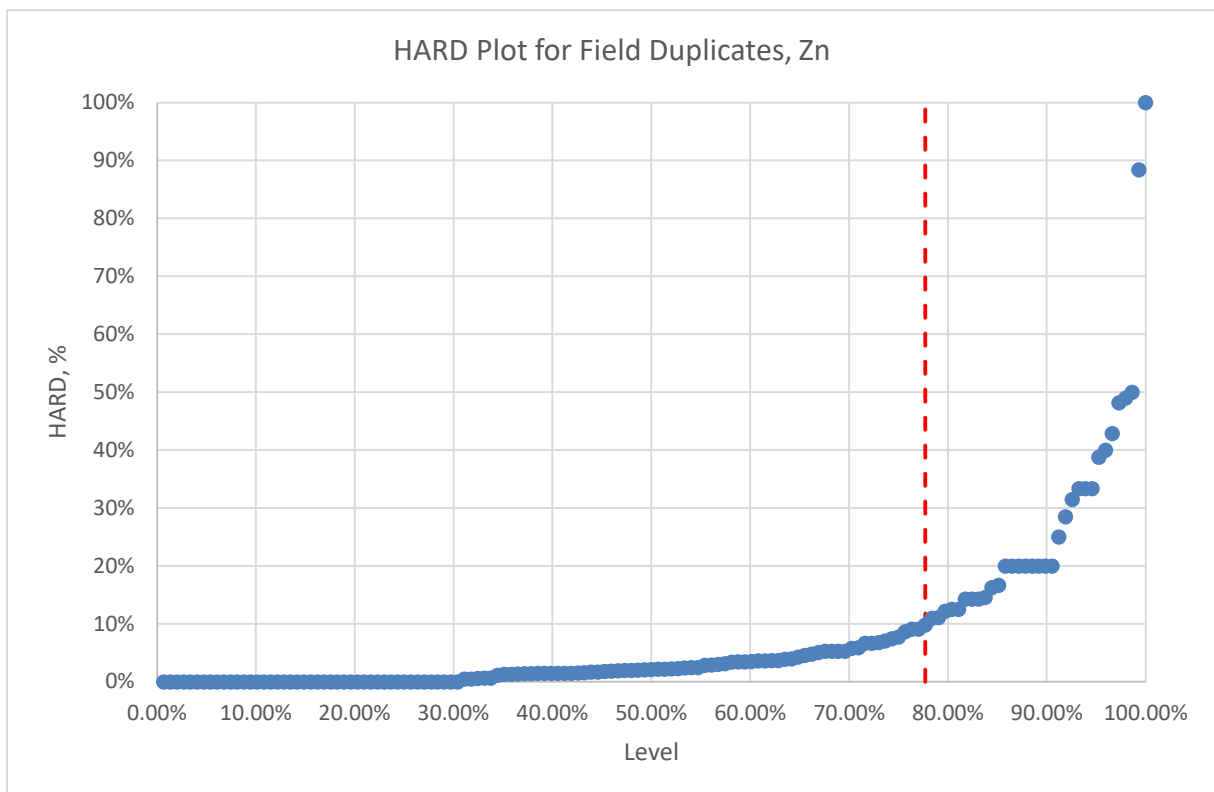


Figure 11.66: HARD Plot for Field Duplicates, Zn

Correlation plots for Pb and Zn for stream samples and duplicates are shown in Figure 11.67 and Figure 11.68.

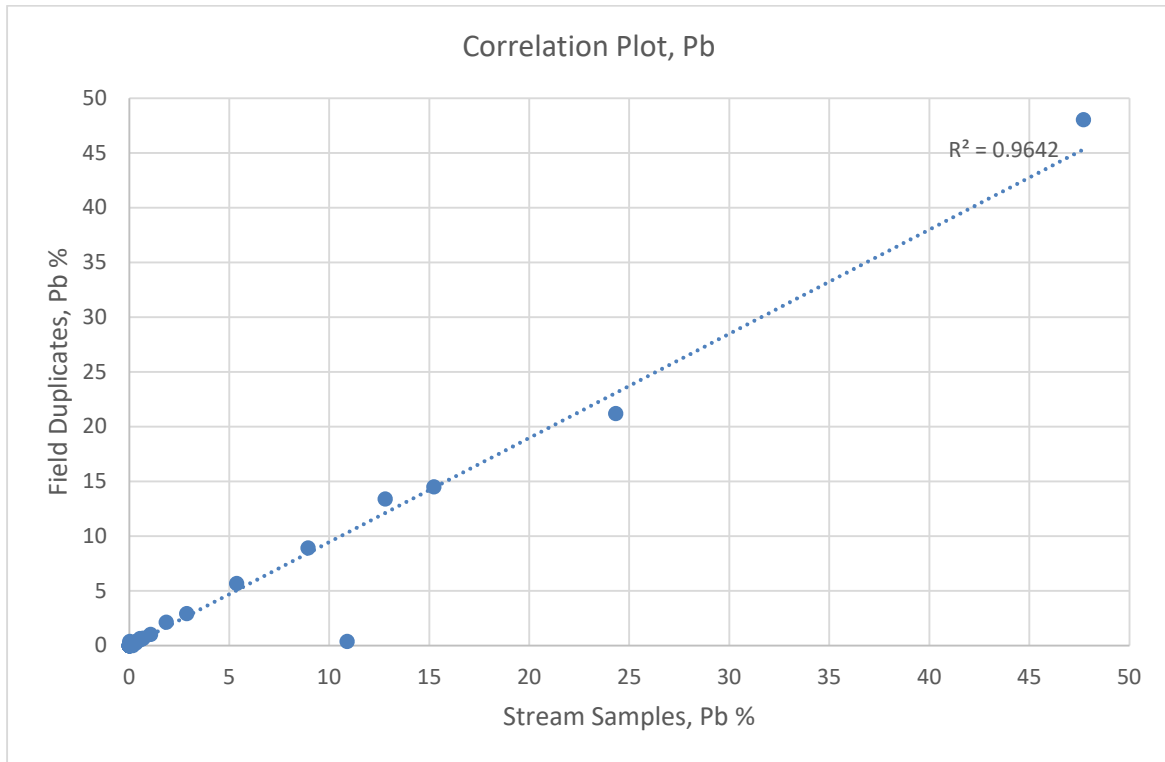


Figure 11.67: Correlation Plot for Field Duplicates, Pb

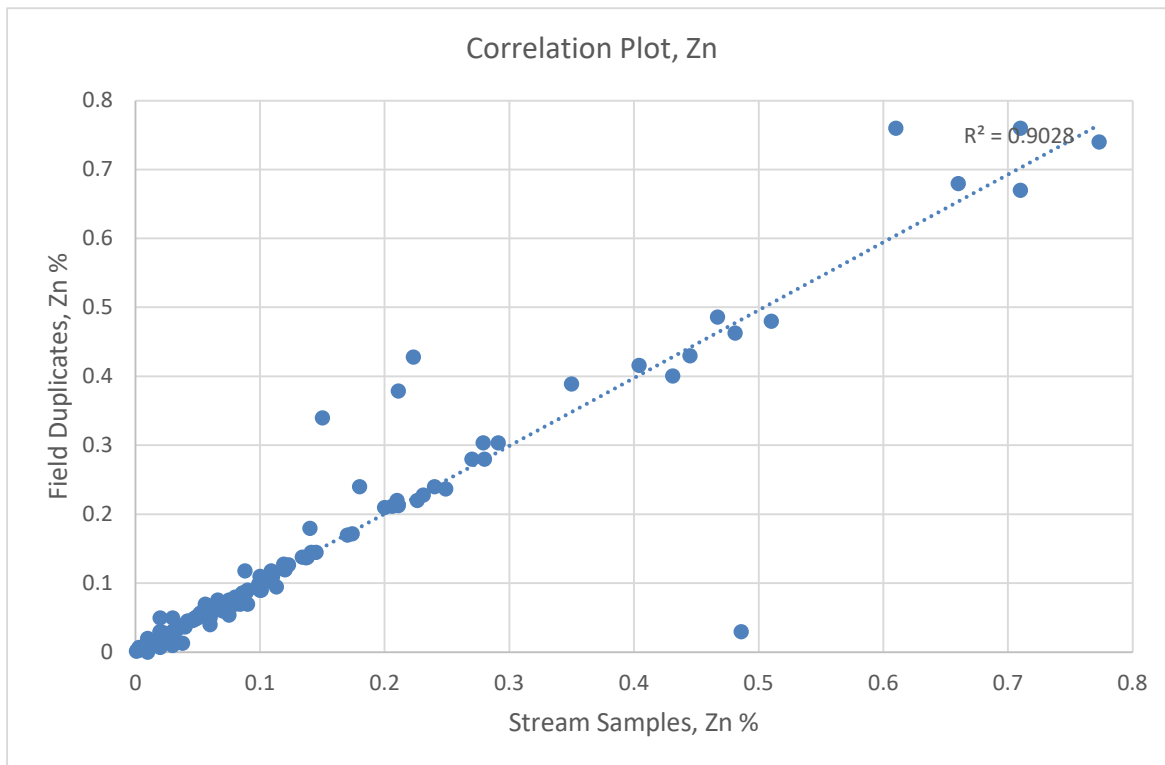


Figure 11.68: Correlation Plot for Field Duplicates, Zn

### 11.7.2 Summary of QA/QC Risks

The WAI review of quality control data has identified a number of risks within the sample data. These risks are summarised in Table 11.8. It should be noted that Table 11.8 does not provide a quantitative risk assessment but gives an indication as to where WAI considers the risk lie within the sampling data.

A six-score classification has been employed where:

- 1 - 2 ('low' risk): Little or no perceived risk, or low uncertainty;
- 3 - 4 ('moderate' risk): Risk present which could lead to small material error in the resource model;
- 5 - 6 ('high' risk): This feature could lead to material error in the resource model (high uncertainty).

Table 11.8: Risk Matrix Verticalny QA/QC Review		
Sample Type	Risk	Comment
Blanks	3	Blanks assay results for Ag show possible contamination, elevated level of Ag mineralisation within the material, and some evidence of mislabeling. Ag grade for more than 10% of blanks from ore sections was higher than 50 g/t – cut-off grade for mineralisation delineation. In general, samples with higher silver grades are preceded by samples with high (more than 100 g/t to first/several thousand g/t) grade of this metal. These failures may be due to minor mineralisation within the blank material, rather than poor practice and do not represent material risk to the project. Zink and lead blanks assaying results are satisfactory.
CRMs	2	CRM assaying results for Ag are satisfactory, there are some insignificant deviations for Zn and Pb assaying results.
Field Duplicates	2	Precision based on HARD data is at an acceptable level, more than 70% of samples are below error limit of 10%.

Total risk related to the quality of sampling, sample preparation and assaying is considered to be 'moderate' - Risk present which could lead to small material error in the resource model. However, WAI would recommend that the QA/QC procedures to be improved by sampling and sample preparation of field duplicates as there is a risk of sample contamination.

WAI would recommend that the QA/QC procedures to be improved by introduction of quartz sand flush into sampling preparation protocol to mitigate the risk of sample contamination, review of blank sample material and possible change to an accredited blank sample material, and that. database management and transcribing results are regularly monitored.



## 12 DATA VERIFICATION

### 12.1 Procedures

WAI completed several checks on the raw data and data entry process to cover a minimum 5% of raw data and understands that recording of data and management of transfer of data from site has been supervised by qualified senior staff.

Logging data in the first instance was recorded by hand to form documentation for each hole that includes collar and down hole survey information and assay information once available. This information was subsequently transferred to an electronic database.

A review of collar locations in the field, review of core logging or review of data from primary assay sheets has not been made at time of writing this report. Significant intersections have not been verified by either independent or alternate company personnel.

No adjustments to assay data have been made.

### 12.2 Location, Spacing, Distribution and Orientation of Data

All data was supplied in the World Geodetic System 1984, Zone 36J Northern Hemisphere (UTM) and it is understood that. Collar positions for all holes were laid out by the on-site surveyor using a differential GPS and then checked again once drilling was completed. Downhole surveys were carried out for all of the diamond drillholes using Reflex Ez-Shot equipment over a nominal interval of 20m in general.

A topographic survey was conducted across the property in 2014. The survey was carried out using Topcon 5GR satellite receiver. The field data was processed using TOPCONTOOLS software package. This survey is used for the current Mineral Resource Estimate. The small differences between the GPS readings and the topographical survey data do not influence the interpreted mineralisation widths.

Data spacing is down to 40m x 40m in the central part of deposit with some area of infill drilling to 25m x 25m. On the flanks the data spacing is more generally between 80m x 80m. Trenching for grade control is developed every 10m on the each 5m bench. This spacing is sufficient to establish geological and mineralisation continuity appropriate for the reporting of Mineral Resources.

Mineral Resources are classified as Measured, Indicated and Inferred in accordance with the guidelines of the JORC Code (2012), and through geostatistical analysis considering the spatial distribution of sample data. Sample compositing was carried out as part of the mineral resource estimation process. The diamond drill and trench data spacing is deemed by the CP to be sufficient to imply/confirm geological and grade continuity, sufficient for the classification of Inferred resources only. The average length of the samples is 0.91m on Vertikalny and 0.85m for North Mangazeisky therefore the composite length of 1.0m was chosen for both datasets.

In general, drilling is carried out so that the intersections of holes with mineralised zones occurs at a high angle which results in limited sample bias. The general strike of mineralisation is to northwest at 310° with sub-vertical steeply dipping mineralisation zone hence drilling is generally inclined at –50-60° towards the strike of the zones. Intercepts are reported as apparent thicknesses except where otherwise stated.

### **12.3 Personal Inspection**

Nikolai Shatkov conducted a site visit to the Property on 30<sup>th</sup> October 2021. At the time of the site visit, the QP inspected the current open pit operations (at Vertikalny), processing plant, inspection of current drilling operations, a visit to the core shed (core cutting and sample preparation), logging facilities, on-site laboratory, sample duplicate/reject storage facilities, and discussions with senior and key geological/technical staff to verify the data collection, sample preparation, and data/sample management procedures.

Core drilling uses modern diamond drilling techniques with double tubed HQ tools and core is transferred directly into purpose wooden core boxes and marked up accordingly (core block between runs and metal tags) before being transferred to the core facility. It was noted that core logging is initially prepared into readymade logging note books before being transcribed into an electronic database, along with data from drilling including coordinates and downhole survey data. It was also noted that sample details for laboratory analysis (including hole ID, sample ID, depth, QC sample type, weight, and analytical method) is also prepared on ready printed sample sheets.

The QP considers that the exploration drilling, sample and data management, and overall Project operation is satisfactory.

### **12.4 Limitations**

Independent verification of drill results has not been performed thus no twin drilling or direct field comparison of sample pairs has been carried out as part of WAI's terms of reference. This has not been felt necessary given adequacy of QA/QC analysis, repeatability of analyses using good industry practices over the course of the project and no reliance on Soviet-era data for evaluation. This situation may need to be reassessed for future exploration and evaluation on Mangazeisky and other deposits.

### **12.5 Opinion on Data Adequacy**

The quality control and assurance data reviewed by the QP indicates the assays are generally within expected limits. The QP is satisfied that data collection, security, spacing and orientation of sample collection is sufficient to support the Mineral Resource classification presented herein. For future exploration work a specific Zn-Pb-Zn CRM may be of benefit, such as OREAS 134a, to add to the CRM list to improve statistical analysis of the Pb/Zn relationship. Further, review of the source and tenor of the blank material used should be undertaken with the possibility of introducing an alternative, verified, blank material.

## 13 MINERAL PROCESSING AND METALLURGICAL TESTWORK

### 13.1 Procedures

The most recent testwork on the sulphide ores for the production of separate lead and zinc concentrates was reported by "NVP-ESTAGEo Centre" LLC in 2018 and the results have been used for pit optimisation in the current work, along with the NSR terms provided by SBR.

### 13.2 Historical Testwork

Historical testwork was completed by TSNIGRI in 2008 and GINTSVETMET in 2011. The main testwork programs for the Feasibility Study were conducted by SGS Vostok in 2014 and TOMS in 2015.

The SGS Vostok testwork program tested a composite sample from the Vertikalny Central zone representing higher-grade oxide ore to be mined in the early years of operation. The TOMS testwork program consisted of leach variability testwork for oxide, transition and primary ore samples, followed by leach optimisation and comminution testwork on a composite primary ore sample, again from the Vertikalny Central zone at greater drill hole depths.

#### 13.2.1 Oxide Ore

Vertikalny ore is characterised as a polymetallic silver-lead-zinc partially oxidised ore, with acanthite as the most abundant silver mineral, but also metallic silver, silver chlorides, silver-rich tetrahedrite, silver-antimony-lead and silver-lead sulphosalts. Diagnostic leaching indicated that approximately 90% of the silver in the oxide sample is amenable to cyanidation at a grind size of 80% passing 75 microns. The ore is moderately hard with a Bond Work Index of 14.3kWh/t.

In summary, the Tetra Tech analysis of the testwork program results indicated that the Vertikalny oxide ore is amenable to standard agitated cyanide leaching, with **design silver recovery of 85%**, although this includes a gravity circuit recovering approximately 8% of the silver with cyanide leaching of the gravity tailings. Testwork clearly indicates that, without the gravity circuit, additional leach residence time with higher cyanide concentration and higher pH is required to maintain leach recovery. The leach residence time increases from approximately 72 hours to 96 hours with and without the gravity circuit respectively, with the pH increasing from 10.5 to 11.5 and the cyanide concentration from 2,000ppm to 5,000ppm respectively.

The TOMS whole ore leach variability results, using leach conditions of 2,000ppm cyanide, pH 11.5, 120 hours residence time and the grind size of 80% passing 75 microns indicated that the oxide sample recovery averaged 82.4%, while the transitional and primary sample recovery decreased significantly to an average of 44.4% and 28.2% respectively.

### 13.2.1.1 *Direct Electrowinning*

Due to the high silver head grades and the remote location of the deposit, Tetra Tech recommended the use of direct electrowinning for the cyanide leached solution, rather than by the conventional Merrill Crowe process. Testwork was conducted by Electrometals LLC in 2014 using a leach solution prepared by SGS Vostok that assayed 798ppm Ag. The results showed that the silver could be depleted to <5 ppm after 2 hours electrowinning. Copper was also depleted to low values, although depletion of the zinc was less efficient, decreasing from approximately 1,900ppm to 1,000ppm. The silver powder collected from the cathode was smelted to produce silver bullion assaying 99.9% Ag. Therefore, based on the completed direct electrowinning test work, Tetra Tech concluded that direct electrowinning technology could be effectively utilised, and this was incorporated into the process design with an assumed electrowinning efficiency of 99%.

### 13.2.2 *Primary Ore*

The primary ore composite tested by TOMS was collected from 27 samples over 11 separate drill holes and with an average silver head assay of 371g/t Ag. The primary ore is significantly harder with a Bond Work Index of 19.0kWh/t.

Initial whole ore leach tests using the same optimised conditions as for the oxide ore leach variability tests returned a low silver recovery of only 29.4%. Under optimised leach conditions obtained by using a finer grind of 80% passing 25 microns and increasing the cyanide concentration to 10,000ppm, then silver recovery of approximately 71% was obtained, with the leach kinetics being extremely slow. Tetra Tech then calculated a design silver recovery of 69.6%, assuming the same use of the direct electrowinning circuit.

Bulk flotation testwork recovered 93.6% of the silver to a concentrate assaying 2,333g/t Ag at a 15% mass pull to concentrate, but unfortunately intensive cyanidation of this concentrate recovered only 26.7% of the silver, even at a fine grind of 80% passing 25 microns and with a cyanide concentration of 30,000ppm.

Further evaluation of the flotation option was not considered by Tetra Tech due to the remoteness of the project and perceived potential difficulties in logistics, with the idea of keeping the operation as simple as possible. It is also stated in the feasibility study that only approximately 10% of the feasibility study ore reserves are primary ore, although this only includes Vertikalny. Therefore, Tetra Tech recommended use of the oxide plant design for sulphide ore processing, but with the necessary modifications to allow for the finer grind and longer leach residence time required at higher cyanide concentrations.

Subsequent to the Tetra Tech feasibility study, further work on the flotation option for primary ore was performed by "NVP-ESTAGEo Centre" LLC in 2018, particularly as the undeveloped Mangazeisky deposit is almost 100% primary ore.

This work focussed on producing separate lead and zinc concentrates with cyanide leaching of the lead circuit middlings. Locked cycle tests were conducted, and primary lead flotation was undertaken at pH 7-9 using A3418 collector and zinc sulphate to depress the sphalerite. A lead concentrate was produced, and tailings scavenged to produce a lead circuit middlings which was cyanide leached and the scavenger tailings which reported to the zinc circuit. Primary zinc flotation was conducted at approximately pH 12 using xanthate collector and copper sulphate for sphalerite activation to produce zinc concentrate. After scavenging the zinc rougher tailings a final tailing was produced and the scavenger concentrate recycled.

The results of this testwork are summarised in Table 13.1.

<b>Table 13.1: Summary of Locked Cycle Flotation Testwork on Primary Ore</b>							
<b>Products</b>	<b>Mass, %</b>	<b>Assays, %</b>			<b>Recovery, %</b>		
		<b>Ag, g /t</b>	<b>Pb</b>	<b>Zn</b>	<b>Ag</b>	<b>Pb</b>	<b>Zn</b>
<b>Flotation</b>							
Pb Concentrate	4.54	10,215	17.1	4.4	66.0	65.9	4.6
Pb-Ag Middlings	6.84	2,357	3.6	5.6	23.0	21.0	8.8
Zn concentrate	8.50	400	0.4	42.3	4.8	3.1	82.2
Tailings	80.12	53.9	0.15	0.24	6.2	10.0	4.4
<b>Initial Sample</b>	<b>100.0</b>	<b>702.0</b>	<b>1.18</b>	<b>4.37</b>	<b>100.0</b>	<b>100.0</b>	<b>100.0</b>

Cyanide leach testwork on the lead middlings product indicated a silver recovery of 68.1% could be achieved. Allowing for direct electrowinning efficiency and solution losses, an overall design silver recovery of 85.4% was calculated for primary ore. This is considered reasonable for pit optimisation studies. The lead and zinc recoveries are **65.9%** and **82.2%** respectively, although the appropriate NSR terms must then be applied. SBR has used indicative metal recoveries in their forecast performance data and, while the silver and zinc recoveries are in line with the above testwork results, the lead recovery at approximately 80% is significantly higher than the 65.9% indicated and the latter has been used for the pit optimisation studies.

The chemical analysis of the concentrates is shown in Table 13.2.

Element	Assay, %	
	Lead Concentrate	Zinc Concentrate
<b>Ag, g/t</b>	<b>10,215</b>	<b>400</b>
<b>Pb</b>	<b>17.06</b>	<b>0.43</b>
<b>Zn</b>	<b>4.38</b>	<b>42.27</b>
Fe	26.16	11.83
S	29.00	22.00
Cu	3.87	0.20
As	1.95	0.81
Cd	<0.02	0.18
Sb	1.01	0.06
In	<0.02	<0.02
Sn	0.19	0.11
SiO <sub>2</sub>	6.53	9.22
NaO	<0.1	<0.1
MgO	0.31	0.55
Al <sub>2</sub> O <sub>3</sub>	1.67	3.71
K <sub>2</sub> O	0.87	1.40
CaO	0.26	0.62
TiO <sub>2</sub>	0.11	0.19
P <sub>2</sub> O <sub>5</sub>	0.03	0.06
MnO	0.97	1.22
Cl	0.06	0.04
Cr	<0.02	0.08

The lead concentrate at only 17% Pb is very low compared to typical lead concentrates grading 50% - 70% Pb. However, the silver content is very high at 10,215g/t Ag and so the concentrate is likely to be marketable to an Asian smelter. High levels of arsenic and antimony are indicated which could incur penalties. The copper and zinc in the lead concentrate are unlikely to be payable.

As advised by SBR, a Net Smelter Return (NSR) of **84%** for both the lead and silver has been used for the pit optimisation studies. In due course, a quotation should be sourced based on the concentrate analysis shown in Table 13.2. In addition, the concentrate should be assayed for cobalt, mercury and selenium which are also potential penalty elements.

The zinc concentrate assaying 42.2% Zn is likely to be marketable as a zinc concentrate to a western smelter, with a typical required minimum grade of approximately 45% Zn. High levels of arsenic and silica are indicated which could incur penalties.

Further discussion on concentrate quality and realisation of products is discussed in Section 18.1 of this report.

As advised by SBR, a Net Smelter Return (NSR) of **45%** for both the zinc and silver has been used for the pit optimisation studies.

### **13.3 Limitations**

In due course, a quotation should be sourced based on the concentrate analysis shown in Table 13.2. In addition, the concentrate should be assayed for fluorine, mercury and selenium which are also potential penalty elements.

The figure of 45% for NSR recovery appears a little conservative but should be confirmed with an official quotation and full concentrate elemental analysis to determine the impact of any deleterious elements.

### **13.4 Opinion on Data Adequacy**

It is WAI's opinion that the previous metallurgical testwork provided a scoping level of accuracy for the basis of developing the process flowsheet and 'reglament'.

## **14 MINERAL RESOURCE ESTIMATION**

### **14.1 Mineral Resource Estimation - Vertikalny**

#### **14.1.1 General Methodology**

The following sections describes the process of Mineral Resource estimation for the Vertikalny silver mine. The estimate has been prepared in accordance with the guidelines of the JORC Code (2012).

The Mineral Resource Estimate (MRE) was carried out using a 3D block modelling approach using Datamine Studio 3 software (Datamine). Exploration data were imported and verified before wireframe modelling. In addition, digital terrain model (DTM) surfaces, surveys of mined-out areas, surfaces of overlapping sediments and boundaries of oxide and primary mineralisation were imported and/or created. Sample data were selected using the geological and mineralisation wireframes and selected samples were assessed for outliers. The wireframe envelopes were used as the basis for a volumetric block model based on a parent cell size of 10m x 10m x 10m. Variogram models were constructed based on composite data and used for grade estimation by ordinary kriging and inverse distance weighting methods. The resultant estimated grades in the block model were validated against the input sample and composite data. Resource classification was undertaken in accordance with the guidelines of the JORC Code (2012) and incorporated an assessment of the geological continuity and complexity, data quality, spatial grade continuity and overall quality of the resource estimation. Mineral Resources were limited based on an expectation of eventual economic extraction by being constrained within an optimised open pit shell generated using Datamine's NPV Scheduler software and underground stopes generated using Datamine's Mineable Shape Optimiser in Studio 5D Planner and appropriate economic and technical parameters.

#### **14.1.2 Software**

The MRE has relied on several software packages for the various stages of the process. However, the main data preparation and validation, wireframe modelling, statistical and geostatistical analysis, block modelling, estimation and validation were performed in Datamine Studio 3 version 3.22.84.0 and Snowden Supervisor version 8.9.0.2.

#### **14.1.3 Data Transformations**

All data are stored using the same local co-ordinate system and the same unit convention based on the WGS84 system. Therefore, transformations of drillhole or other data were not required.

##### **14.1.3.1 Sample Database**

Sample data is contained in two databases. The first comprises the exploration database which includes all exploration drilling (drill core) from 2006 to 2015 and exploration trenching (also from 2006 to 2015). The second comprises the grade control trench sample database used for short-term mine planning using 10m spaced trenches (5m high benches).



The grade control database is from 2007 to 2018. The exploration and grade control databases were provided by the Client in Microsoft® Access and Excel format and consisted of the files shown in Table 14.1 and Table 14.2, respectively.

<b>Table 14.1: Exploration Database Files</b>					
<b>Collar File</b>		<b>Assay File</b>		<b>Survey File</b>	
<b>Column</b>	<b>Explanation</b>	<b>Column*</b>	<b>Explanation</b>	<b>Column</b>	<b>Explanation</b>
Project	Site	Project	Site	Project	Site
Hole	Working Number	Hole	Working Number	Hole	Working number
Length	Depth/length of working	From_m	Interval from	Depth	Measured depth
UTM_Grid	Coordinate system	To_m	Interval to	Dip	Dip angle
UTM_East	Collar easting	DHSample	Sample number	Measured_Azimuth	Working azimuth
UTM_North	Collar northing	Sample_Type	Sample type	<b>Lithology File</b>	
UTM_Elevation	Collar elevation	Primary_Sample	Original sample number for duplicate sampling	Project	Site
Azimuth	Azimuth of drilling	Au_OL_ppm	Au, g/t	Hole	Working Number
Dip	Angle of drilling	Ag_OL_ppm	Agg/t	From_m	Interval from
Hole_Type	Type of working	Cu_OL_pct	Cu, %	To_m	Interval to
Drill_Rig	Drill rig model	Pb_OL_pct	Pb, %	Lith1	Code of rock
Timestamp	Completion date	Zn_OL_pct	Zn, %	Lith1_Oxidation	Degree of oxidation
* assays for 32 elements are not included in the estimate					

<b>Table 14.2: Grade Control Database Files</b>					
<b>Collar File</b>		<b>Assay File</b>		<b>Survey File</b>	
<b>Column</b>	<b>Explanation</b>	<b>Column*</b>	<b>Explanation</b>	<b>Column</b>	<b>Explanation</b>
Project	Site	Project	Site	Hole_id	Working number
Hole	Working Number	Trench	Working Number	From	Measured depth
Length	Depth/length of working	Sample	Sample number	Azimuth	Working azimuth
UTM_Grid	Coordinate system	From_m	Interval from	Dip	Dip angle
UTM_East	Collar easting	To_m	Interval to	<b>Lithology File</b>	
UTM_North	Collar northing	Length	Sample length	Project	Site
UTM_Elevation	Collar elevation	Mass_sample	Sample weight	Trench	Homep working number
Azimuth	Azimuth of drilling	Ag, g/t	Ag grade	From_m	Interval from
Dip	Angle of drilling	Cu, %	Cu grade	To_m	Interval to
End	Data closed	Pb, %	Pb grade	Litocod	Code of rock
		Zn, %	Zn grade	Sample_Type	Sample type
		Sample_Type	Sample type		
* assays for the key elements using AA and ICP					

#### 14.1.3.2 Database Review

A review of the sample databases was undertaken by WAI. The database includes data for core drillholes and trenches which were carried out during exploration campaigns and grade control trenches. The drilling and trenching was carried out in 2006-2018. The number of assayed samples split by type of developments and periods are shown in Table 14.3.

Year	Type	Number of Assays			Comments
		Ag	Pb	Zn	
2006-2009	Trench	1,851	1,818	1,818	
2007	Drillhole	3,271	3,271	3,271	
2008	Drillhole	4,500	4,454	4,453	
2009	Drillhole	2,650	1,968	1,968	
2011	Drillhole	704	704	704	
2012	Drillhole	120	120	120	
2013	Drillhole	525	525	525	
2014	Drillhole	436	436	436	
2014	Trench	144	144	144	
2015	Drillhole	1,001	1,001	1,001	
2017	Drillhole	352			Metallurgical Holes
2018	Drillhole	174	4	4	Grade Control
2018	Trench	4,058	1,015	1,015	Grade Control
<b>Total</b>		<b>19,786</b>	<b>15,460</b>	<b>15,459</b>	

Prior to 2011, analysis was carried out at Russian certified Chemical Laboratory of the State Enterprise Aldangeologiya (Aldan Lab), located in Yakutia, Russia. Analysis for 2012, 2013, 2014, and 2015 campaigns were completed by International Organization for Standardization (ISO)/International Electrotechnical Commission (IEC) 17025 accredited laboratory ALS Chemex in Chita, Russia.

Prior to 2011, the samples sent for fire assay were analysed in duplicate for silver. All samples were sent for fire assay. Samples with significant silver grades, determined from spectral analysis were also analysed for silver, copper, lead, and zinc using atomic absorption (AA). Samples sent for spectral analysis were analysed for 36 elements, including tin, lithium, titanium, cobalt, mercury, and vanadium.

From 2011 onwards, analyses were completed using a four-acid sample digestion of 0.25g, followed by inductively coupled plasma (ICP) finish and reporting of 33 elements (laboratory code ME-ICP62). Where values of silver, lead or zinc exceeded the respective upper detection limits, further four acid digestion analyses were carried out of 0.4g, followed by ICP finish (laboratory code ME-OG62).

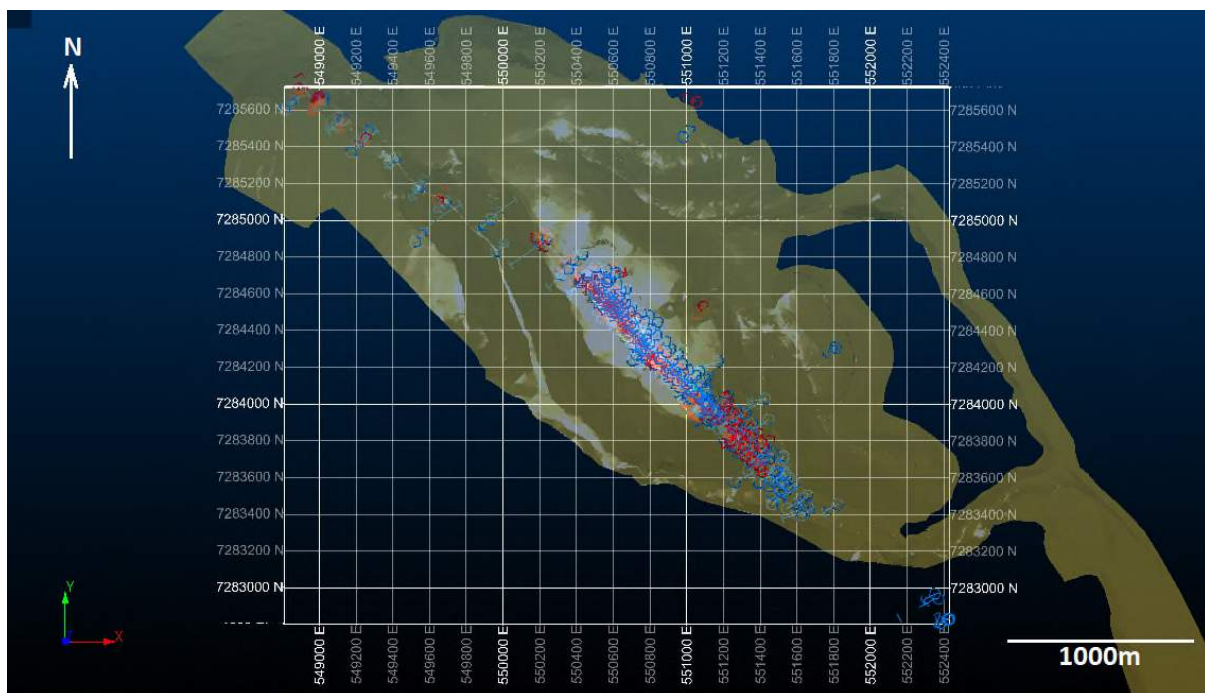
Where values of silver exceeded the upper detection limit for ME-OG62 (1,500g/t), a 50g sample was taken for fire assay analyses with a gravimetric finish (laboratory code Ag- GRA22).

A selection of the samples was identified by the Prognoz geologists for gold assaying. This was undertaken via fire assaying with an AA finish using a 50g sample (laboratory code Au-AA24).

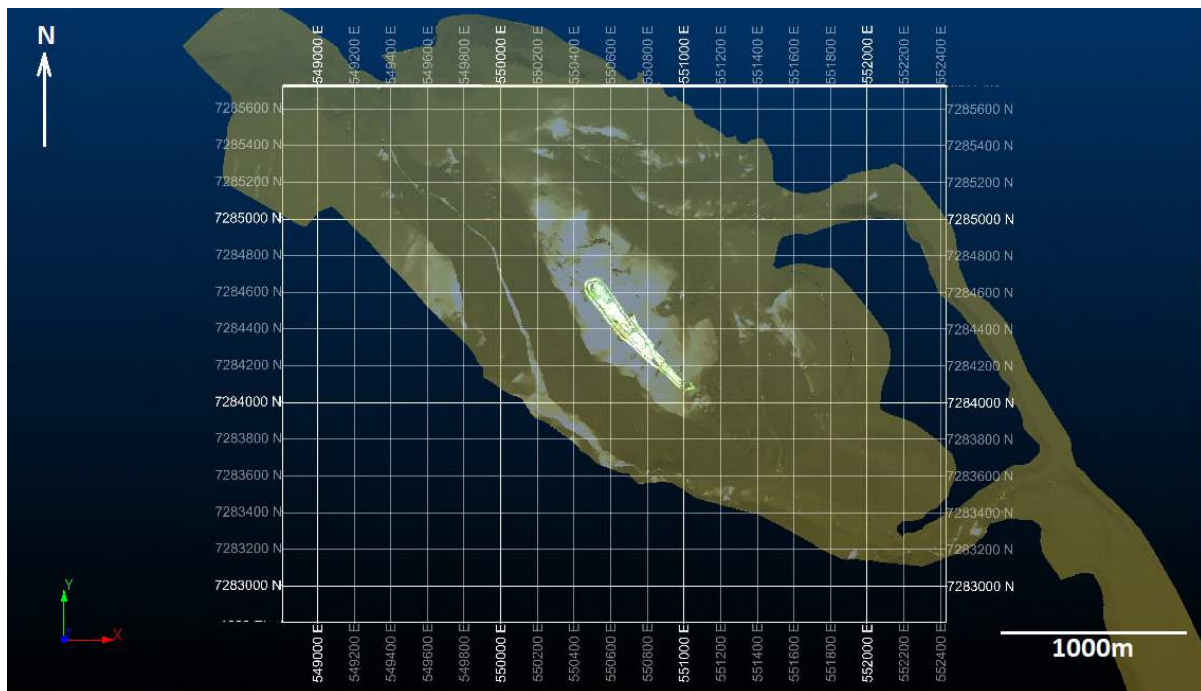
No replacement was done for samples with absent assay data or with zero assay value. The detection limit data was replaced with half of detection limit value for such samples.

#### 14.1.3.3 Database Import

The database was imported by WAI into Datamine© software and desurveyed using the HOLES3D process. Where minor validation errors were discovered in terms of overlapping intervals these were subsequently corrected by WAI. The location of the drillholes / trench samples contained in the database is shown in Figure 14.1 while the location of the open pit is shown in Figure 14.2.



**Figure 14.1: Location of Drillholes (blue) and Trenches (red) at Vertikalny**



**Figure 14.2: Location of Open Pit at Vertikalny Central Area as of May 2019**

#### 14.1.3.4 Data Verification

Data verification was undertaken by WAI following import of the database. A summary of the data verification procedures is detailed below:

- Comparison of historical drillhole logs with the drillhole database;
- Comparison of geological cross sections with the drillhole database;
- Check the presence of blank duplicate and Certified Reference Material in the database;
- Verification that collar coordinates coincide with topographical surfaces;
- Verification that downhole survey azimuth and inclination values display consistency;
- Evaluation of minimum and maximum grade values;
- Evaluation of minimum and maximum sample lengths;
- Assessing for inconsistencies in spelling or coding (typographic and case sensitive errors);
- Ensuring full data entry and that a specific data type (collar, survey, lithology and assay) is not missing and assessing for sample gaps or overlaps;
- Copper and gold were not considered by WAI in the MRE as the reported values are not considered to have economic potential;
- A statistical analysis of grades from the different sample types (drillholes, exploration trenches and grade control trenches) was undertaken by WAI and is summarised in the following section.

#### 14.1.3.5 Final Database

A summary of the exploration database for Vertikalny is shown in Table 14.4. The database contains data for surface core drillholes, exploration trenches and grade control trenches.

<b>Table 14.4: Final Database</b>		
<b>Type of Working</b>	<b>Number</b>	<b>Total Length (m)</b>
Drillholes – exploration	304	44,059.82
Trenches – exploration	76	2,380.88
Trenches – grade control	210	4,383.26
<b>Total</b>	<b>590</b>	<b>50,823.96</b>

#### 14.1.4 Geological Interpretation and Wireframe Modelling

##### 14.1.4.1 Introduction

CJSC Prognoz has provided a topographical pit survey DTM as of May of 2019. Topographical survey DTM in AutoCAD format prior start of mining was also provided to WAI.

The summarised results of metallurgical mapping to assess oxide/primary mineralisation boundary was also provided as a vertical long section through Vertikalny deposit.

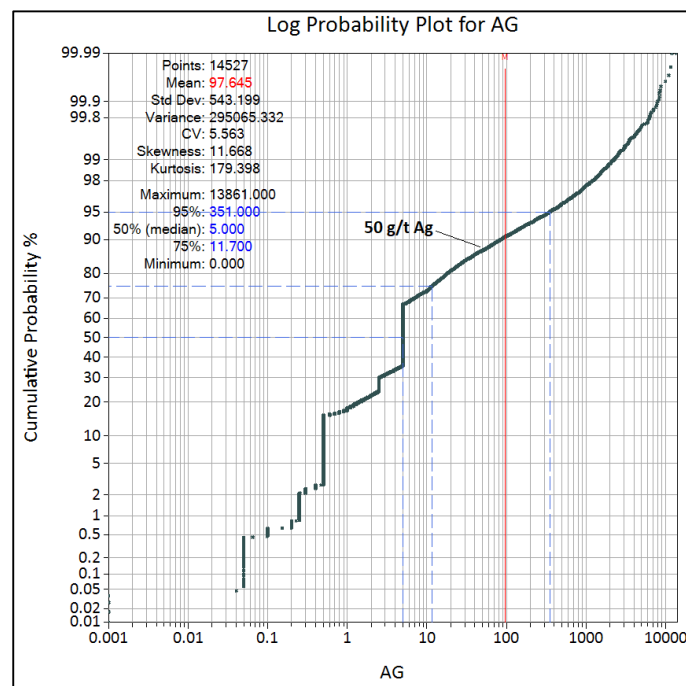
Also, WAI has modelled a DTM of the overburden material using geological logging data from drillholes.

##### 14.1.4.2 Geological Interpretation

The Vertikalny deposit consists of a hydrothermal vein type deposit containing silver, lead and zinc mineralisation in economic quantities with minor copper and gold. Mineralisation is strongly structurally controlled and is hosted within a main fault structure which strikes northwest and extends for 3.5km. Three main zones (Zones 1 to 3) are found within the overall structure. The zones dip sub-vertically and mineralisation has been defined to a depth of 800m. The thickness of the zones is generally less than 4m. Zone 1 comprises the central area (current open pit) whilst Zone 2 and Zone 3 comprise the south-eastern and north-western areas, respectively. Some additional minor mineralised structures (Zones 4 to 9) propagate from Zones 1 and Zone 2, however the tonnages contained in these propagating structures are less significant.

##### 14.1.4.3 Mineralisation Wireframe modelling

The wireframes were constructed using a cut-off grade of 50g/t Ag. This cut-off is considered by WAI to reflect a “natural” cut-off grade for the deposit and corresponds to an inflexion in the population of Ag grades as shown in Figure 14.3.



**Figure 14.3: Log Probability Plot of Ag grades for Sample Data**

Wireframes of the mineralisation contained within the nine structural zones were produced by WAI using the exploration database and grade control database to guide the interpretation.

A minimum sample thickness (interval) of 1m and a maximum waste interval of 3m was used by WAI during construction of the mineralised zones. In order to maintain mineralised continuity, and/or to avoid unnecessary splitting of the mineralised intervals, there was some flexibility permitted in the parameters during wireframe modelling.

The nine mineralised zones defined by WAI at Vertikalny (Figure) including three largest zones – Zone 1 (central area), Zone 2 – (south-east area) and Zone 3 (north-west area). The remained zones are being apophysis of the Zones 1 and 2 have a short strike length and traced in 2-3 up to 5 neighbouring exploration profiles. The general mineralisation strike is north-west at 320-325° with sub-vertical dip. A plan view showing the location of the zones within the main fault structure is shown in Figure 14.4. An isometric view showing the zones of central area in more detail is shown in Figure 14.5 and Figure 14.6.

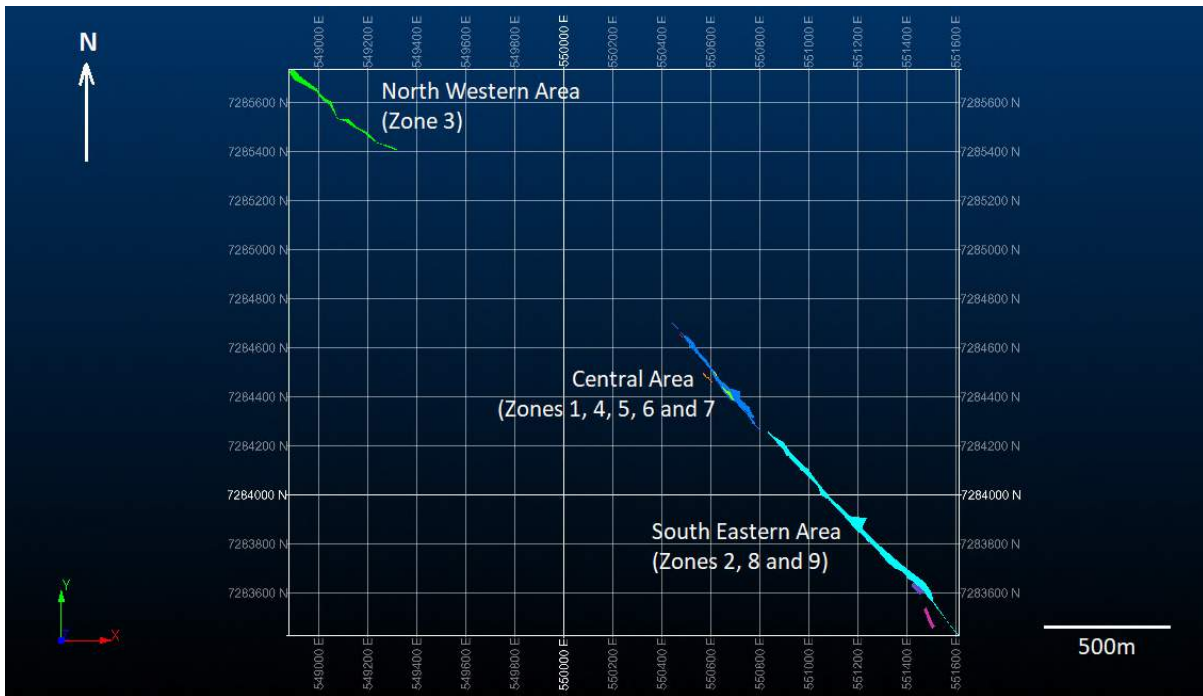


Figure 14.4: Plan View Showing Location of Mineralised Zones

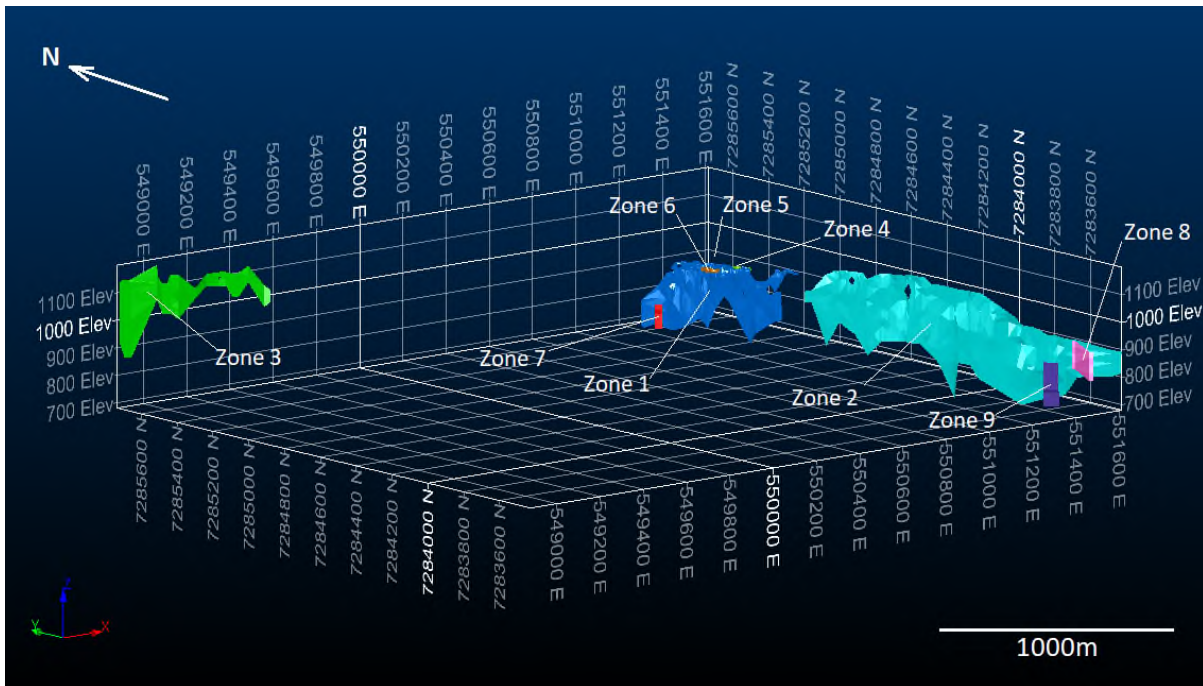
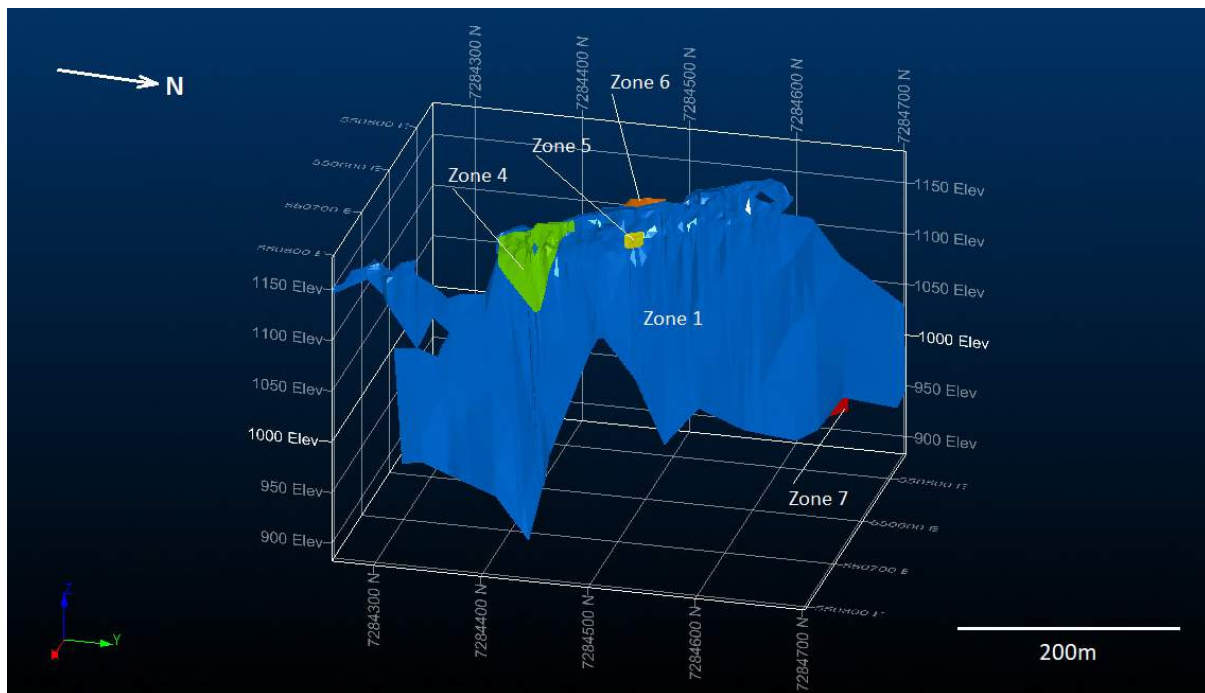


Figure 14.5: Isometric View of Mineralised Zones



**Figure 14.6: Isometric View of Central Area Only Showing Mineralised Zones**

WAI considers the cut-off grade parameters used to be appropriate for the mineralisation at Vertikalny and are also appropriate for an open pit mining scenario. WAI considers that sufficient continuity of mineralisation is exhibited at this cut-off upon which to define the mineralised zones.

**i) Oxidation**

Oxide and primary mineralization is present at Vertikalny. A semi-oxide (mixed) type of mineralization was also distinguished, however, direct cyanide leaching of this mineralisation is characterized by generally low silver recoveries, similar to the primary mineralisation. As a result, all semi-oxidised mineralisation is therefore considered as primary.

The degree of oxidation can be determined visually during geological logging of mine workings. To confirm the identified types of mineralisation, additional phase analyses were carried out to assay for total sulphur and sulphur sulfide. The degree of oxidation was determined based on the sulphur sulfide to sulphur total proportion:

- < 50% sulphur sulphide – oxide ores; and
- ≥50% sulphur sulphide – primary ores (including semi-oxide).

In 2014-2015, the degree of oxidation was determined from proportion of iron oxide and iron total:

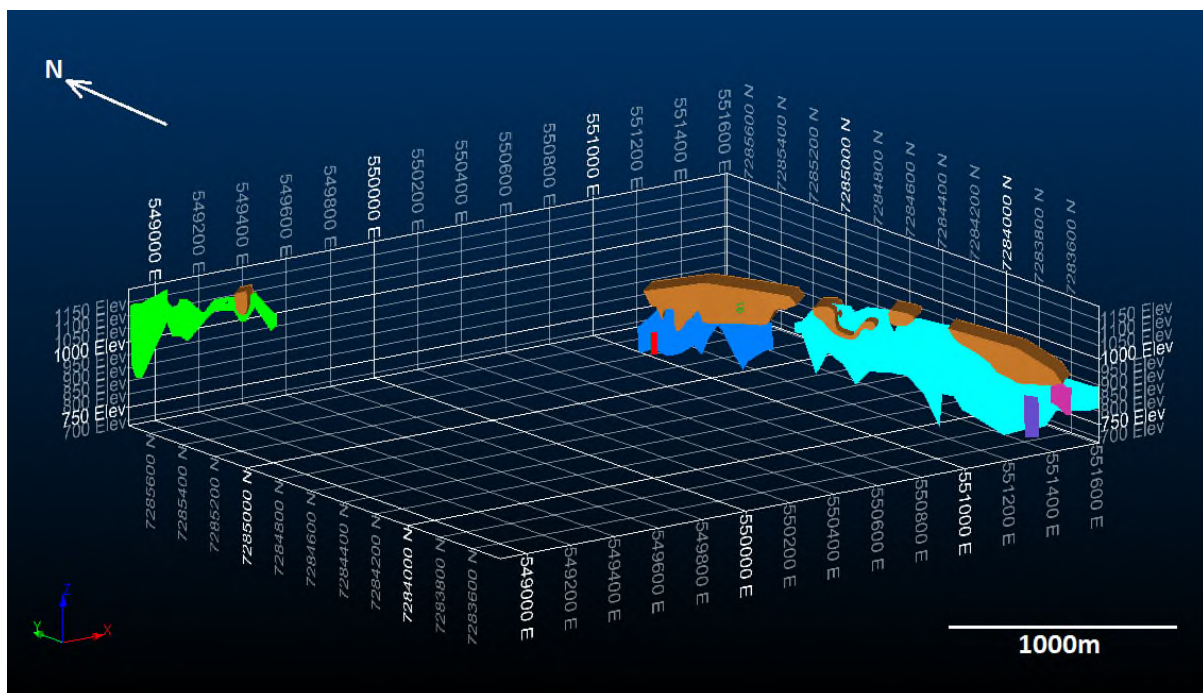
- 90% iron oxide to iron total – oxide ores;
- < 90% - semi-oxide and primary ores.



Additional studies on flotation concentration following a single processing flowsheet were carried out in 2017-2018 on samples taken based on visual assessment of the degree of oxidation.

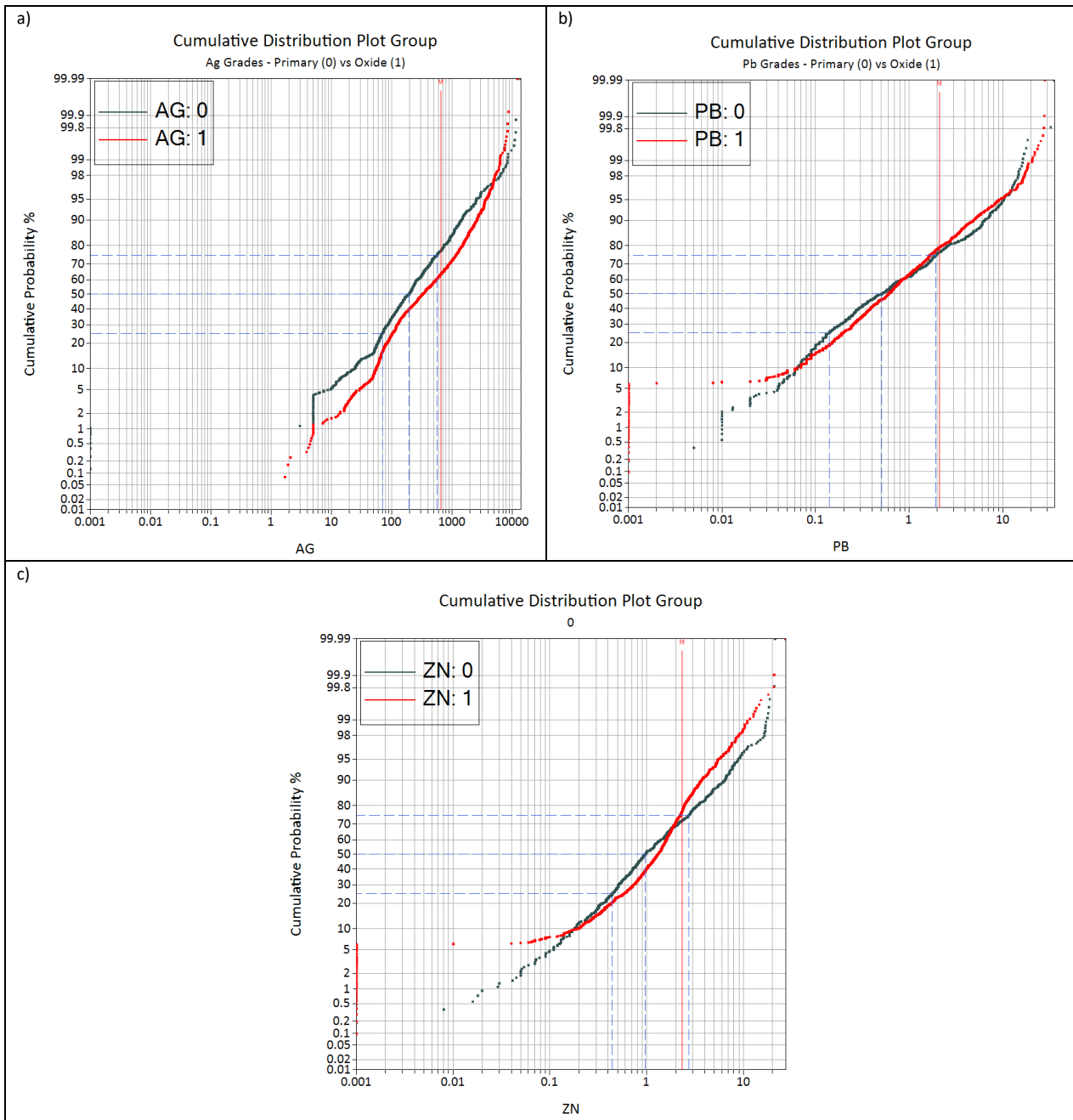
Based on the oxidation data, geological-metallurgical mapping was undertaken by the Client to determine the boundaries of the oxidation zone. The results were represented as a vertical section at Vertikalny. The zone of oxidation is seen to have a complicated morphology. The bulk of oxide mineralisation is confined to near-surface areas, although the depth of the oxidation zone is occasionally over 100m below the surface. At the same time, primary ores locally outcrop. The greatest depth of the oxidation zone is confined to the center of the deposit.

A wireframe solid depicting the zones of oxidation was created by WAI and is shown in Figure 14.7.



**Figure 14.7: Modelled Zones of Oxidation at Vertikalny**

A statistical analysis was undertaken by WAI to compare the oxide and sulphide grades to assess the need for separate domaining. Log probability plots for silver, lead and zinc were produced by WAI and are shown in Figure 14.8. A slightly higher-grade population for silver is potentially seen to be associated with the oxide mineralisation, while slightly higher zinc grades appear to be associated with the primary mineralisation. The lead grades appear consistent between the oxide and primary. Overall, the grade populations observed in the oxide and primary mineralisation are considered to be relatively similar, however due to the slight differences seen in the silver and zinc grades, WAI has elected to consider the oxide and sulphide mineralisation as separate domains.



**Figure 14.8: Log Probability Plots Comparing Grades for Oxide and Primary Mineralisation for a) Ag, b) Pb and c) Zn**

**ii) Lithology**

As it was mentioned above, mineralisation of Vertikalny is associated with steeply dipping mineralized tectonic zones of north-west strike. The zones are composed of quartz-carbonate-sulphide material. The host rock is represented by interbedding of aleuolite, sandstone and argillite. The sub-surface area is covered by diluvial sediment with thickness of the overburden material of first meters.

A wireframe surface of the overlying sediments based on the drillhole logging data was constructed by WAI and incorporated in the resource model. No further domaining based on lithology was undertaken by WAI.

### 14.1.5 Drillhole Data Processing

Drillhole samples from the verified database were selected within the mineralised zone wireframes and were further sub-divided based on oxide/primary mineralisation types. To preserve the integrity of the assay sample lengths, the drillhole files containing only assay data were used (rather than assay and lithology combined). The final selected samples were coded by the principal domains and formed the basis of the Mineral Resource Estimate. A summary of the sample data contained in each domain is shown in Table 14.5.

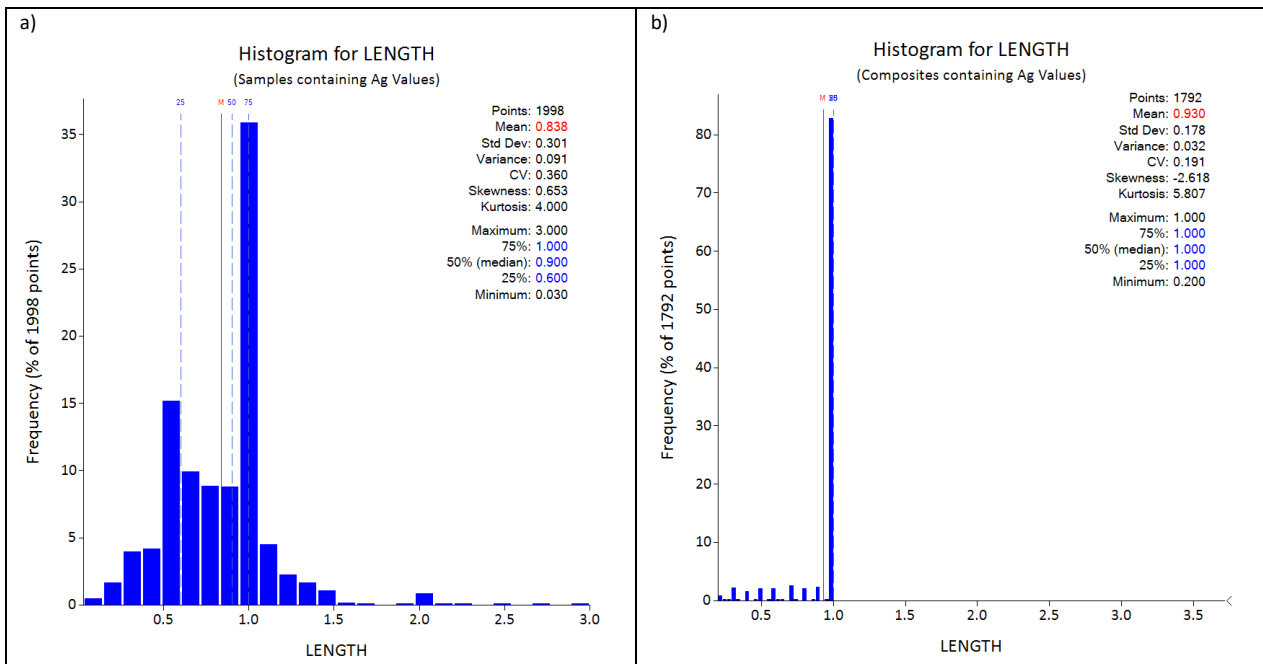
<b>Zone</b>	<b>Type</b>	<b>Workings*</b>	<b>Samples**</b>	<b>Total (m)</b>	<b>Ave Length (m)</b>
1	Oxide	214	993	976.30	0.98
1	Primary	43	200	148.60	0.74
2	Oxide	42	130	105.90	0.81
2	Primary	112	499	439.39	0.88
3	Oxide	1	1	1.40	1.40
3	Primary	17	63	59.35	0.94
4	Oxide	21	87	71.50	0.82
4	Primary	5	17	16.00	0.94
5	Oxide	6	11	11.30	1.03
6	Oxide	18	32	30.80	0.96
7	Primary	1	4	4.30	1.08
8	Primary	2	9	5.05	0.56
9	Primary	4	10	7.10	0.71
<b>Total for Oxide</b>		<b>302</b>	<b>1,254</b>	<b>1,197.2</b>	<b>0.95</b>
<b>Total for Primary</b>		<b>184</b>	<b>802</b>	<b>679.79</b>	<b>0.85</b>
<b>Total</b>		<b>486</b>	<b>2,056</b>	<b>1,876.99</b>	<b>0.91</b>
* the total number of workings is 590, some workings do not access the mineralization; moreover, some workings intersect more than one mineralised zone					
** not all samples contain recorded assay values					

A statistical analysis of Ag, Pb and Zn grades by domain is shown in Table 14.6.

Table 14.6: Statistical Analysis of Selected Samples								
Type	ZONE	No. of Samples	Minimum	Maximum	Mean	Variance	Standard Deviation	Coefficient of Variation
<b>Ag (g/t)</b>								
Oxide	1	972	1.7	12,247.70	1,021.54	2,104,823	1,451	1.42
	2	129	5	7,476.00	604.55	1,363,705	1,168	1.93
	3	1	224	224.00	224.00	-	-	-
	4	87	4.55	3,530.00	547.62	520,060	721	1.32
	5	11	55.24	530.00	237.24	16,345	128	0.54
	6	32	35	3,054.00	436.45	416,248	645	1.48
	7	-	-	-	-	-	-	-
	8	-	-	-	-	-	-	-
	9	-	-	-	-	-	-	-
Primary	1	191	5	13,861.00	1,256.66	6,752,610	2,599	2.07
	2	484	0	7,147.00	461.85	618,495	786	1.70
	3	61	5	2,768.00	452.75	347,265	589	1.30
	4	16	80	3,991.73	842.16	1,076,388	1,037	1.23
	5	-	-	-	-	-	-	-
	6	-	-	-	-	-	-	-
	7	4	3	1,590.00	746.75	394,521	628	0.84
	8	8	106.77	589.00	260.85	37,577	194	0.74
	9	10	87	769.50	209.99	37,181	193	0.92
<b>Pb (%)</b>								
Oxide	1	804	0	28.29	2.02	15.79	3.97	1.97
	2	116	0.045	22.00	1.63	9.43	3.07	1.88
	3	1	1.4	1.40	1.40	-	-	-
	4	74	0	27.70	1.42	11.99	3.46	2.43
	5	7	0	3.22	1.00	1.67	1.29	1.29
	6	28	0	18.90	3.71	34.42	5.87	1.58
	7	-	-	-	-	-	-	-
	8	-	-	-	-	-	-	-
	9	-	-	-	-	-	-	-
Primary	1	143	0.01	35.60	1.92	27.21	5.22	2.71
	2	321	0.01	15.98	1.86	8.08	2.84	1.53
	3	44	0.005	16.50	4.81	23.01	4.80	1.00
	4	16	0	7.67	1.28	4.27	2.07	1.61
	5	-	-	-	-	-	-	-
	6	-	-	-	-	-	-	-
	7	4	0.01	0.19	0.13	0.00	0.07	0.55
	8	8	0.359	14.85	4.55	37.36	6.11	1.34
	9	5	0.07	4.48	1.17	2.80	1.67	1.43
<b>Zn (%)</b>								
Oxide	1	804	0	13.61	1.82	3.42	1.85	1.01
	2	116	0.06	27.22	1.67	17.73	4.21	2.53
	3	1	0.37	0.37	0.37	-	-	-
	4	74	0	14.59	2.63	9.57	3.09	1.17
	5	7	0	2.48	1.18	0.53	0.72	0.61
	6	28	0	3.89	1.67	1.30	1.14	0.68
	7	-	-	-	-	-	-	-
	8	-	-	-	-	-	-	-
	9	-	-	-	-	-	-	-
Primary	1	143	0.016	20.90	2.08	10.19	3.19	1.53
	2	321	0.03	21.22	2.39	10.12	3.18	1.33
	3	44	0.029	18.10	2.78	26.35	5.13	1.85
	4	16	0	17.70	3.40	29.79	5.46	1.61
	5	-	-	-	-	-	-	-
	6	-	-	-	-	-	-	-
	7	4	0.008	0.47	0.28	0.03	0.17	0.61
	8	8	0.38	4.86	2.85	2.77	1.66	0.58
	9	5	0.19	3.14	0.96	1.24	1.11	1.16

### 14.1.5.1 Compositing

A histogram of the lengths of the selected samples which contain Ag values is shown in Figure 14.9. The majority of sample lengths are 1m or less with relatively few samples greater than 1m. A 1m composite interval was therefore selected by WAI. Compositing was carried out within each domain and composites were coded by these domains. A minimum composite interval of 0.20m was used by WAI to prevent excessively small composites being generated. Composites less than this length were rejected. Only relatively few samples are greater than 1m, therefore WAI considers that decompositing of these samples to 1m length will not have a significant impact on the MRE.



**Figure 14.9: a) Histogram of Lengths of Selected Samples, b) Histogram of Composite Lengths**

### 14.1.5.2 Statistical Analysis by Sample Type

Statistical analysis of the grades for drillholes exploration trenches and grade control trenches for Vertikalny is in Table 14.7. The average grade of silver and lead from grade control trenches is higher than the grade from exploration workings. The average zinc grade is in general the same in grade control and exploration developments.

Type of Working	Metal	Qty of composites	Grade		
			Min	Max	Average
Exploration drillholes	Ag (g/t)	866	3	11,832.50	664.11
Exploration trenches	Ag (g/t)	127	23.05	3,800.11	473.71
Grade control trenches	Ag (g/t)	799	4.2	8,801.00	950.49
Exploration drillholes	Pb (%)	620	0.01	26.30	1.68
Exploration trenches	Pb (%)	111	0	19.83	1.89
Grade control trenches	Pb (%)	689	0	28.29	2.12
Exploration drillholes	Zn (%)	620	0.01	20.75	2.25
Exploration trenches	Zn (%)	111	0	21.18	0.96
Grade control trenches	Zn (%)	689	0	17.70	1.79

WAI has carried out statistical analysis of the grades from drillholes, exploration trenches and grade control trenches located within the area of the open pit is shown in Table 14.8. The average silver grades from the exploration drillholes and grade control trenches are almost identical, while lower silver grades report from the exploration trenches, however these are based on the fewest number of samples. The average lead grade is generally higher in the grade control trenches while the average zinc grades are slightly higher in the exploration drillholes. Overall, no significant bias is evident between the different sample types.

Type of Working	Metal	Qty of composites	Grade		
			Min	Max	Ave
Exploration drillholes	Ag (g/t)	72	5	4,920.72	925.78
Exploration trenches	Ag (g/t)	35	25.85	2,574.04	561.72
Grade control trenches	Ag (g/t)	721	4.2	8,801.00	929.36
Exploration drillholes	Pb (%)	45	0.055	18.90	1.40
Exploration trenches	Pb (%)	25	0	19.83	1.64
Grade control trenches	Pb (%)	611	0	24.89	2.01
Exploration drillholes	Zn (%)	45	0.35	8.03	2.41
Exploration trenches	Zn (%)	25	0	1.75	0.62
Grade control trenches	Zn (%)	611	0	17.70	1.82

In general, it can be expected that silver grade will decrease with the depth while lead and zinc grade will be on the same level.

#### 14.1.5.3 Top Cutting

Top cuts were applied to the composites to ensure that anomalously high-grade samples did not bias the grade estimation of the domain. Where outliers were identified, the grade of these composites was reduced to the top cut level. A summary of the top cut levels is shown in Table 14.9. The number of samples which were capped is shown in brackets.

Type	ZONE	Ag (g/t)	Pb (%)	Zn (%)
Oxide	1	None	20 [6]	None
	2	4,000 [2]	15 [2]	15 [3]
	3	None	None	None
	4	None	8 [1]	None
	5	None	None	None
	6	2,000 [1]	17 [2]	None
	7	-	-	-
	8	-	-	-
	9	-	-	-
Primary	1	10,000 [4]	20 [2]	None
	2	4,000 [1]	15 [1]	15 [2]
	3	2,000 [1]	14 [2]	5 [4]
	4	None	None	15 [2]
	5	-	-	-
	6	-	-	-
	7	None	None	None
	8	None	None	None
	9	None	None	None

NB - Number of capped samples shown in brackets

The need for top cutting and the selection of the top cut values was assessed by WAI using quantile analysis of grades and probability plots and are discussed in the following sections.

**i) Quantile Analysis**

Quantile analysis is a recognized rule of thumb to analyze the outliers and determine the appropriate top cutting value. The quantile analysis provides for the samples to be ordered by grades and then the grade values are determined for the first 10% samples, then 20%, 30% etc. The topmost quantile is also checked in percentiles, since it is often required to be analyzed in more detail. Checks on increased quantity and proportion of metal in each quantile and percentile provides an indication if outlier values are present. In general, if the upper quantile (90-100%) contains more than 25-30% of the accumulated metal, then top cutting may be required. If the top 2 or 3 percentiles contain more than 10% of the total accumulated metal, it is recommended that either top cutting be carried out or these values should be isolated as separate high-grade zones. The quantile analysis results for Zone 1 show that 45.47% of Ag metal is contained in the top quantile whilst the accumulated metal in the top percentile exceeds 9%. WAI therefore considers that there is a need to top cut these outlier composites. The results of all quantile analysis are contained in Appendix 1.

**ii) Probability Plots**

Probability plots were used by WAI to further assess the presence of outlier grades and to select appropriate top cut values. Example log probability plots showing the top cut levels selected for Ag in Zone 1, Zone 2, Zone 3 and Zone 6 are shown in Figure 14.10, Figure 14.11 and Figure 14.12, respectively.

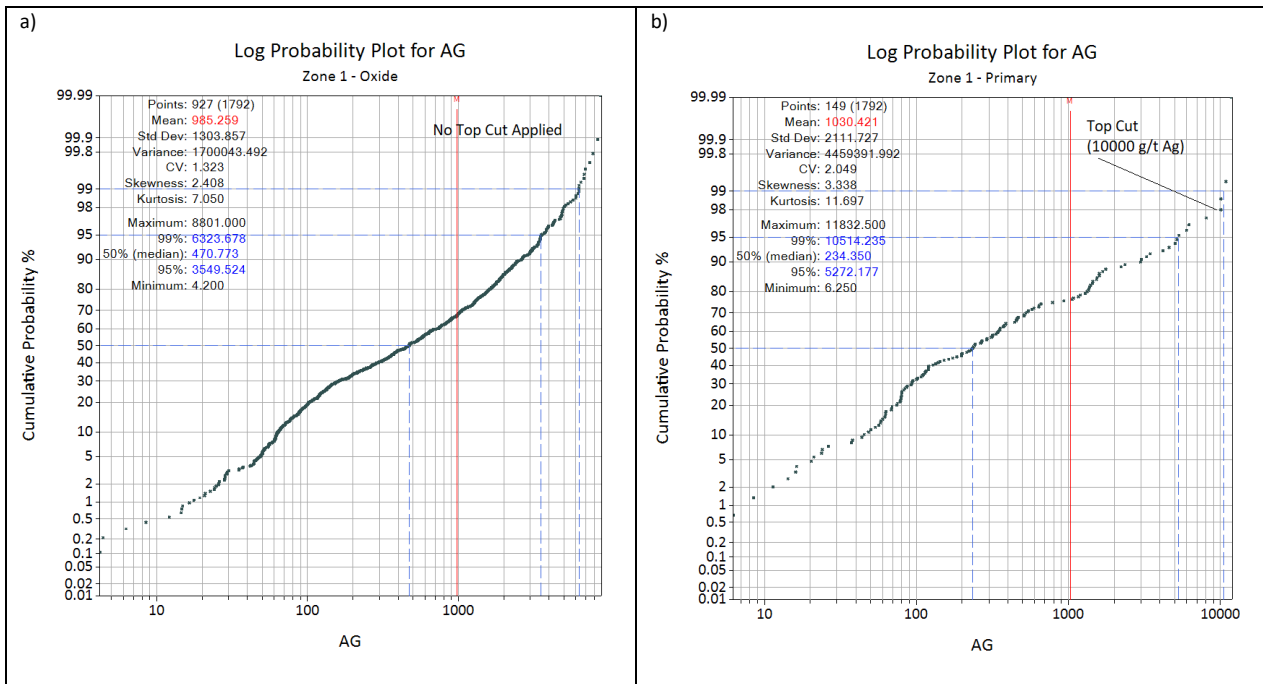


Figure 14.10: Log Probability Plots Showing Top Cut Levels for Ag for Zone 1 - a) Oxide, b) Primary

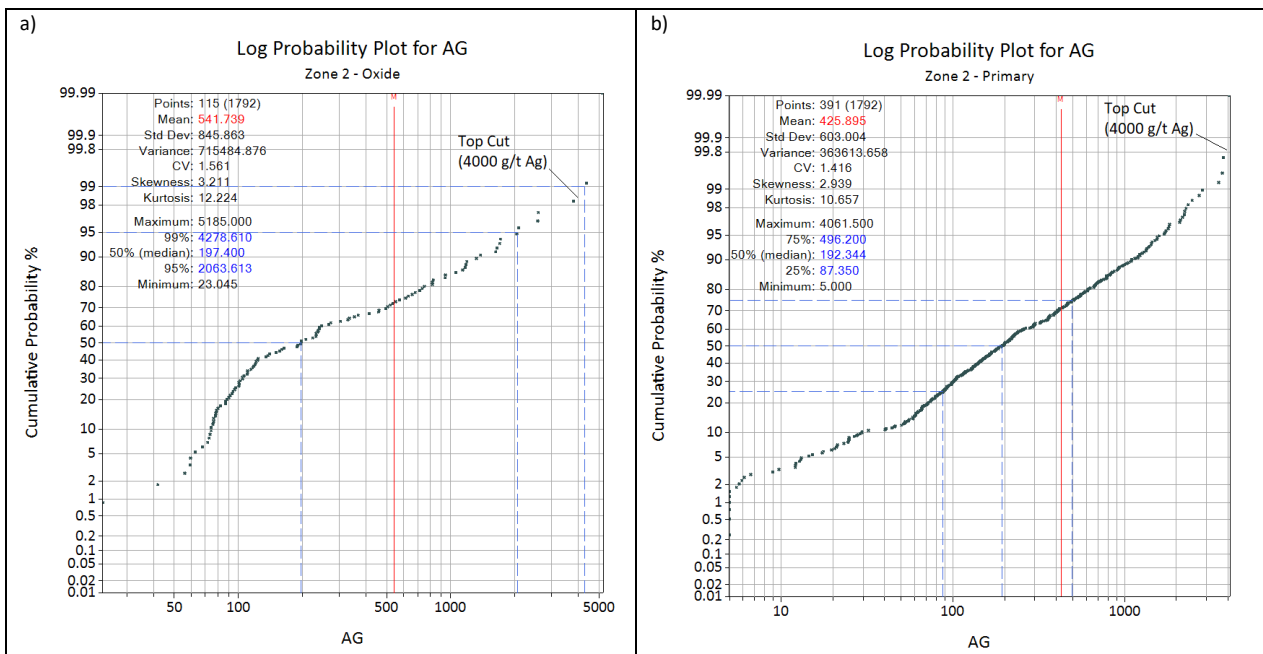
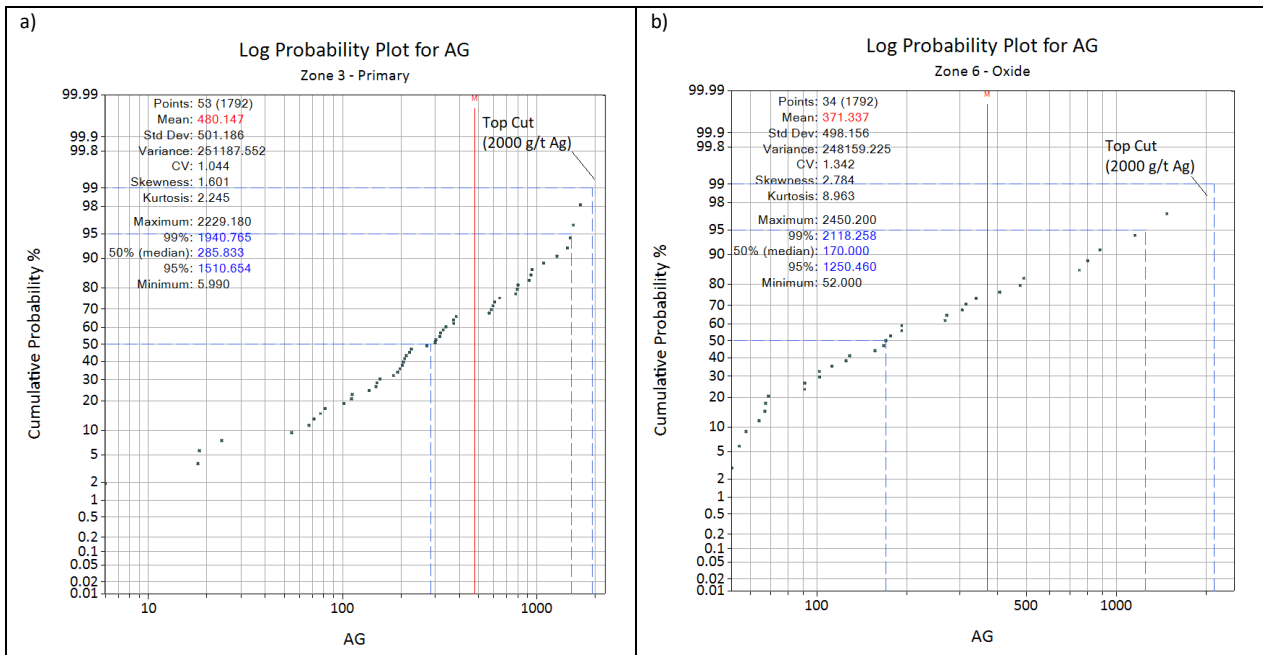


Figure 14.11: Log Probability Plots Showing Top Cut Levels for Ag for Zone 2 - a) Oxide, b) Primary





**Figure 14.12: Log Probability Plots Showing Top Cut Levels for Ag for: a) Zone 3 - Primary, b) Zone 6 - Oxide**

**14.1.5.4 Final Composites**

Statistical analysis by domain of the final composites (after top cutting) is shown in Table 14.10. Overall, no significant effect on the mean grade is observed as a result of compositing or top cutting.

**Table 14.10: Statistical Analysis of Composites**

Type	ZONE	No. of Samples	Minimum	Maximum	Mean	Variance	Standard Deviation	Coefficient of Variation
<b>Ag (g/t)</b>								
Oxide	1	927	4.2	8,801.00	985.26	1,698,210	1,303	1.32
	2	115	23.045	4,000.00	528.28	602,620	776	1.47
	3	2	224	224.00	224.00	-	-	-
	4	75	4.55	2,727.12	497.26	283,525	532	1.07
	5	13	80.74	530.00	257.10	18,908	138	0.53
	6	34	52	2,000.00	358.10	191,593	438	1.22
	7	-	-	-	-	-	-	-
	8	-	-	-	-	-	-	-
	9	-	-	-	-	-	-	-
Primary	1	150	6.25	10,000.00	1,004.53	4,029,859	2,007	2.00
	2	405	0	4,000.00	411.02	355,101	596	1.45
	3	53	5.99	2,000.00	475.82	232,294	482	1.01
	4	15	80	2,839.94	896.32	801,608	895	1.00
	5	-	-	-	-	-	-	-
	6	-	-	-	-	-	-	-
	7	5	3	1,590.00	646.16	356,090	597	0.92
	8	5	106.77	589.00	276.59	32,891	181	0.66
	9	8	87	87	769.50	226.74	45,073	212
<b>Pb (%)</b>								
Oxide	1	754	0	20.00	1.89	11.70	3.42	1.81
	2	106	0.06	15.00	1.66	7.47	2.73	1.65
	3	2	1.4	1.40	1.40	-	-	-
	4	64	0	8.00	1.15	2.42	1.56	1.36
	5	9	0.01	3.22	1.19	1.82	1.35	1.13
	6	32	0	17.00	3.13	28.34	5.32	1.70
	7	-	-	-	-	-	-	-
	8	-	-	-	-	-	-	-
	9	-	-	-	-	-	-	-
Primary	1	111	0.01	20.00	1.47	13.11	3.62	2.46
	2	271	0.01	15.00	1.76	5.85	2.42	1.37
	3	42	0.005	14.00	4.42	18.17	4.26	0.96
	4	15	0	6.43	1.22	2.87	1.69	1.39
	5	-	-	-	-	-	-	-
	6	-	-	-	-	-	-	-
	7	5	0.01	0.19	0.13	0.00	0.06	0.48
	8	5	0.359	14.85	5.32	28.11	5.30	1.00
	9	5	0.07	4.48	1.17	2.80	1.67	1.43
<b>Zn (%)</b>								
Oxide	1	754	0	13.26	1.77	2.71	1.65	0.93
	2	106	0.0616	15.00	1.39	8.51	2.92	2.10
	3	2	0.37	0.37	0.37	-	-	-
	4	64	0	12.78	2.63	8.51	2.92	1.11
	5	9	0.416	2.48	1.28	0.36	0.60	0.47
	6	32	0	3.89	1.63	1.17	1.08	0.66
	7	-	-	-	-	-	-	-
	8	-	-	-	-	-	-	-
	9	-	-	-	-	-	-	-
Primary	1	111	0.017	12.14	1.90	6.61	2.57	1.35
	2	271	0.034	15.00	2.22	6.97	2.64	1.19
	3	42	0.029	5.00	1.31	1.78	1.34	1.02
	4	15	0	15.00	3.88	27.06	5.20	1.34
	5	-	-	-	-	-	-	-
	6	-	-	-	-	-	-	-
	7	5	0.008	0.47	0.28	0.02	0.15	0.55
	8	5	0.38	4.53	2.93	2.76	1.66	0.57
	9	5	0.19	3.14	0.96	1.24	1.11	1.16

### 14.1.6 Variography

The top-cut composites were used for modelling of experimental semi-variograms. To provide sufficient sample pairs, WAI elected to combine the oxide and primary mineralisation during the variogram analysis. Robust variogram models were produced for Ag at Zone 1 and Zone 2. Robust variogram models were also produced for Pb and Zn at Zone 2. Due to a low number of composites, and/or their irregular spacing, it was not possible to model robust variograms for the remainder of the zones and metals. Examples of the along strike and down-dip modelled variograms for Ag at Zone 2 is shown in Figure 14.13 and Figure 14.14. The parameters of all modelled variograms are presented in Table 14.11.

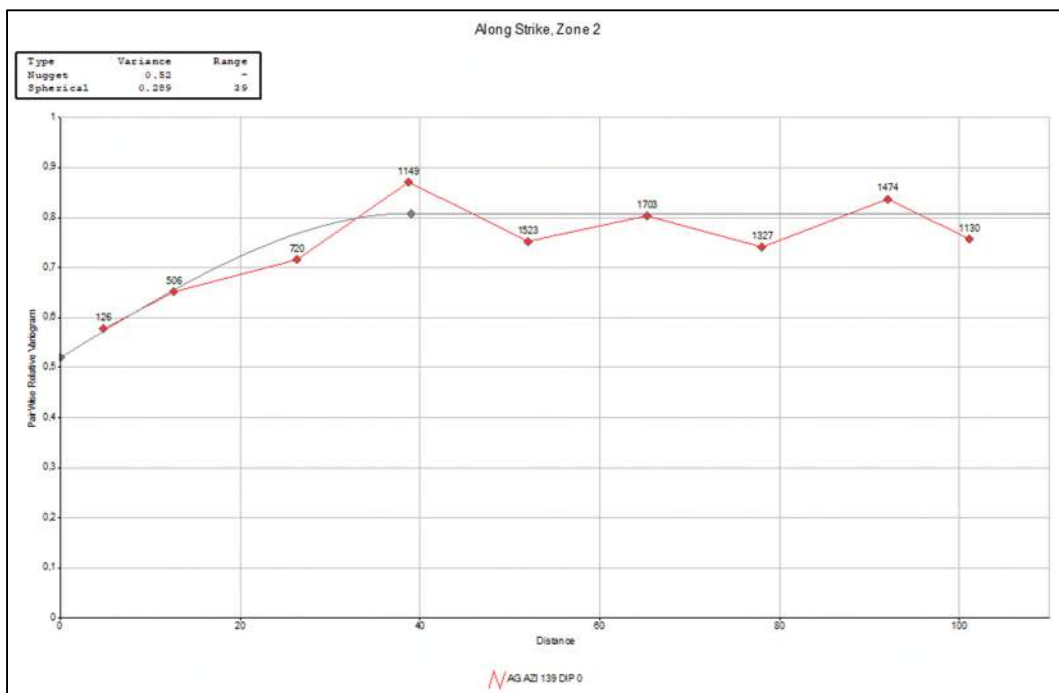


Figure 14.13: Ag Modelled Variogram, Zone 2, Along Strike

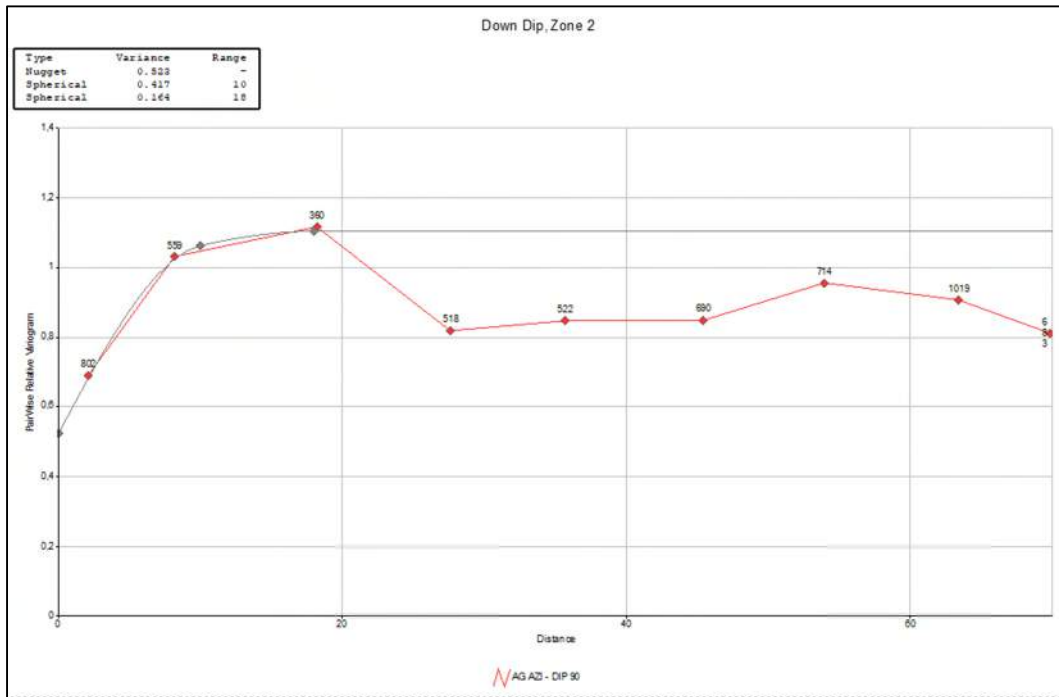


Figure 14.14: Ag Modelled Variogram, Zone 2, Down-Dip

Table 14.11: Parameters of Modelled Variograms

Parameter	Along Strike				Down-Dip				Across Strike			
	Ag	Ag	Pb	Zn	Ag	Ag	Pb	Zn	Ag	Ag	Pb	Zn
Zone	1	2	2	2	2	1	2	2	1	2	2	2
File	z1wcomp	z2tcomp	z2tcomp	z2tcomp	z2tcomp	z1tcomp	z2tcomp	z2tcomp	z1tcomp	z2tcomp	z2tcomp	z2tcomp
Lag	14	13	18	16	9	8	20	20	2	2	3	3
Nlag	8	8	8	8	8	10	8	8	8	8	6	6
HorAng	20	50	30	50	50	20	60	50	30	30	60	50
VerAng	20	50	30	50	50	20	60	50	30	30	60	50
CylRad	50	80	20	20	80	20	90	40	50	50	90	40
Ang1	139	139	139	139	49	49	49	49	49	49	49	49
Ax1	3	3	3	3	3	3	3	3	3	3	3	3
Ang2	-	-	-	-	90	90	90	90	-	-	-	-
Ax2	-	-	-	-	1	1	1	1	-	-	-	-
VarType	RV	RV	RV	RV	RV	RV	RV	RV	RV	RV	RV	RV
MoRefNo	2	3	8	11	4	5	9	12	6	7	10	13
Nugget	0.03	0.52	0.36	0.191	0.52	0.509	0.485	0.035	0.325	0.256	0.267	0.133
R1	19.9	38.7	91.2	49.5	9.6	10.2	43.3	71.2	2.5	2.2	3.3	6.2
C1	0.362	0.289	0.48	0.324	0.42	0.231	0.165	0.354	0.228	0.359	0.325	0.411
S1	0.391	0.809	0.84	0.515	0.94	0.74	0.651	0.39	0.553	0.615	0.592	0.544
R2	55.8	-	-	-	18.3	31.7	65.6	99.7	4.2	6	5.9	-
C2	0.044	-	-	-	0.16	0.114	0.11	0.494	0.355	0.369	0.317	-
S2	0.436	-	-	-	1.1	0.854	0.761	0.884	0.907	0.984	0.909	-

The large range for silver from Zone 1 is associated with strike direction. For Zone 2 the ranges along strike and down dip are similar and have 38.7 and 31.7m. The range for lead is 91.2m along strike and 65.6m down dip. For zinc down dip range is 99.7m whereas along strike is 49.5m. The across strike

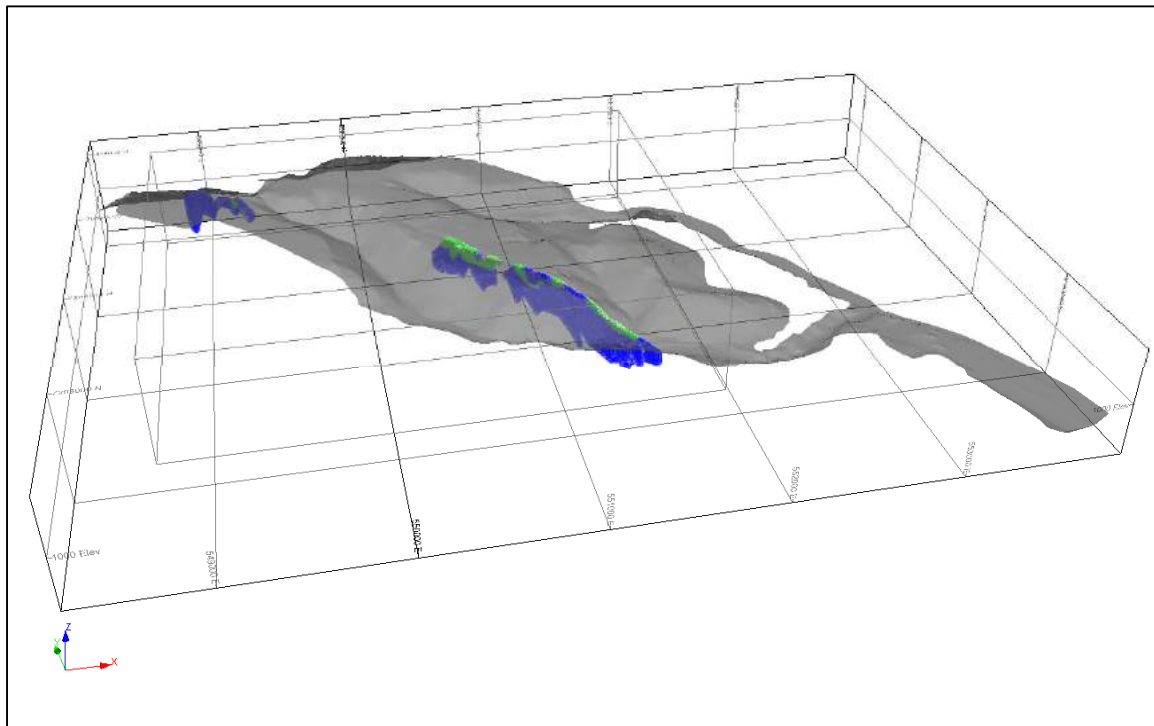
ranges for all metals are similar with the length being around the first meters. The nugget value is relatively high with covariance from 0.2 to 0.5.

**14.1.7 Block Modelling**

The block model was constructed using Datamine with a parent cell size of 10m x 10m x 10m (along strike, across strike and vertical), sub-celling was allowed down to 1.0m x 1.0m x 2.0m. The block model was created within the individual zone wireframes. The block model also reflects the DTM surface before mining and depleted volume as of May 2019. In addition, the model comprises oxide and primary ores, also outlines the blocks corresponding to unconsolidated sediments overlying the bedrock. No rotation has been applied to the model. A summary of the parameters used in the model prototype is shown in Table 14.12.

Table 14.12: Block Model Prototype			
Parameters		Direction	Size
Model Origin		X	548,685
		Y	7,283,257
		Z	667
Model Parameters	Parent Block Size	X	10
		Y	10
		Z	10
	Number of Blocks	X	667
		Y	330
		Z	269

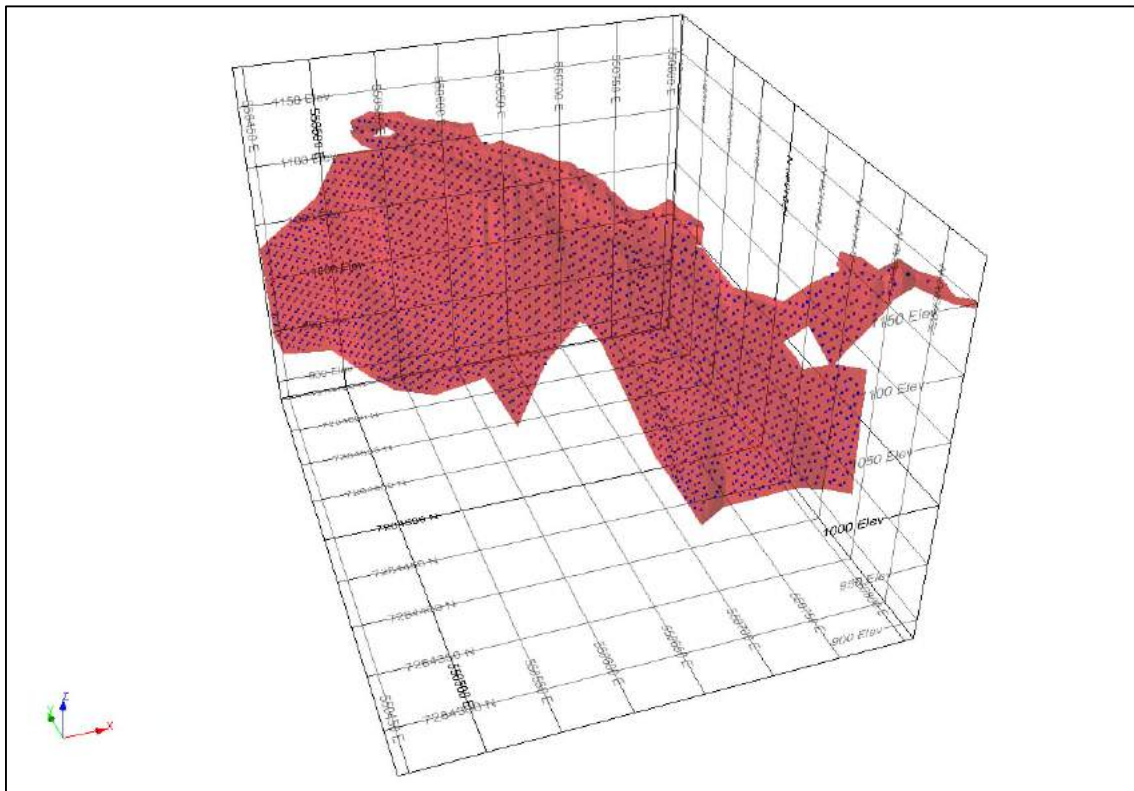
The block model with outlined oxide and primary mineralisation is shown in Figure 14.15.



**Figure 14.15: Block Model of Mineralisation - Green: oxide, Blue: primary**

Parameters of dynamic anisotropy showing the true dip angle and azimuth were interpolated into the blocks of each individual zone of mineralisation. In order to produce the points with true dip angle and azimuth WAI modelled wireframes corresponding with the axial surfaces of mineralized zones. Points with true dip angles and azimuth corresponded with the centers of triangles of these wireframes.

An example of the points used for dynamic anisotropy for Zone 1 is shown in Figure 14.16.



**Figure 14.16: Wireframe Model of Zone 1 with Points Used to Determine Dynamic Anisotropy**

#### 14.1.8 Density

Density of rocks and ores was studied on 173 samples taken from the core of the 2004-2012 drillholes. It was determined on site and field duplicates were analyzed in State Unitary Mining and Geological Laboratory Yakutskgeology, Republic of Sakha (Yakutia). The summarized data on 144 samples with assays and referenced to the drillholes depths are shown in Table 14.13.

<b>Table 14.13: Density Data for Samples taken in 2004-2012</b>			
<b>Type of Ore</b>	<b>Average Density for 144 determinations (g/cm<sup>3</sup>)</b>		
	<b>In-House Lab</b>	<b>Yakutskgeology</b>	<b>Average</b>
Primary + mixed	3,575	3,594	3,584
Oxide	3,125	3,206	3,166

In 2012, a total of 88 samples were taken for primary ores in Drillhole V12-198A of 74m deep to determine the density; the average value amounted to 3.50t/m<sup>3</sup>.

As part of the processing studies of ores undertaken by TOMS Engineering LLC in 2015 a total of 53 samples were taken to determine the ore density. The laboratory testwork resulted in the following density values:

- Oxide ores – 3.17g/cm<sup>3</sup>
- Mixed ores – 3.38g/cm<sup>3</sup>
- Primary ores – 3.59g/cm<sup>3</sup>

Investigation of the correlation relationship between the grades of elements of interest (silver, lead, and zinc) with regard to all the previous studies showed a weak dependence between the metal/s grades and density (the correlation coefficient is 0.08 to 0.19). No tendency to decrease/increase in density with depth was determined.

Determination of natural moisture content was carried out both at exploration and development of the deposit. The average value of moisture content based on the mining data from June to December 2018 was 5.6%.

Currently, ZAO Prognoz is using the following density values for development of Vertikalny:

- Oxide mineralisation – 3.13t/m<sup>3</sup>
- Primary and mixed mineralisation – 3.56t/m<sup>3</sup>
- Host rocks – 2.75t/m<sup>3</sup>

The mixed zone at Vertikalny is not significant, therefore no separate mixed zone has been included by WAI in the resource model. The MRE is based on the ZAO Prognoz values for density.

#### **14.1.9 Grade Estimation**

Grade estimation was performed only on mineralised material defined within each mineralised zone with oxide and sulphide mineralisation estimated separately. The domains were treated as hard boundaries and composites from an adjacent domain could not be used in the grade estimation of another domain. Ordinary Kriging (OK) and inverse distance weighting to power 3 (IDW<sup>3</sup>) estimations were undertaken.

##### **14.1.9.1 Grade Estimation Plan**

Grade estimation was undertaken for Ag, Pb and Zn. The estimates were run in a nine-pass plan, with each consecutive pass using progressively larger search radii to enable the estimation of blocks un-estimated on the previous pass. The search parameters were derived from the variography. The first search distances corresponded to the distance at 1/3<sup>rd</sup> of the variogram range, the second search corresponded to the distance at 2/3<sup>rd</sup>s of the variogram range with the third search distance up to the variogram range. The remaining searches were used to ensure that all blocks contained within the domains were estimated.

The OK method was used as the principal estimation method for all domains. Variogram model parameters for Zone 1 were used for the estimation of Ag for all domains in which no suitable variograms could be derived. Variogram model parameters for Zone 2 were used for the estimation



of Pb and Zn all domains in which no suitable variograms could be derived. Sample weighting during grade estimation was determined by variogram model parameters. The IDW<sup>3</sup> method was also used for all domains as a secondary (check) estimation method.

Grade estimation was carried out using a parent block size of 10m x 10m x 10m. Sub-cells received the same grade as the parent cell. Block discretisation was set to 3 x 3 x 3 to estimate block grades. Search ellipse orientations were controlled by dynamic anisotropy. A summary of the grade estimation plan is shown in Table 14.14.

Zone	Metal	Search Distance (m)				Composites		Minimum Octants
		Search	Down Dip	Along Strike	Across Strike	Minimum	Maximum	
Zone 1 and Zones 3 to 9	Ag	1 <sup>st</sup>	6.1	18.6	1.4	2	8	2
		2 <sup>nd</sup>	12.2	37.2	2.8	2	8	2
		3 <sup>rd</sup>	18.3	55.8	4.2	2	8	2
		4 <sup>th</sup>	36.6	111.6	8.4	2	8	2
		5 <sup>th</sup>	73.2	223.2	16.8	2	8	2
		6 <sup>th</sup>	109.8	334.8	25.2	2	8	2
		7 <sup>th</sup>	146.4	446.4	33.6	2	8	1
		8 <sup>th</sup>	292.8	892.8	67.2	1	15	1
		9 <sup>th</sup>	549	1674	126	1	15	1
Zone 2	Ag	1 <sup>st</sup>	10.6	12.9	2.0	2	8	2
		2 <sup>nd</sup>	21.1	25.8	4.0	2	8	2
		3 <sup>rd</sup>	31.7	38.7	6	2	8	2
		4 <sup>th</sup>	63.4	77.4	12	2	8	2
		5 <sup>th</sup>	126.8	154.8	24	2	8	2
		6 <sup>th</sup>	190.2	232.2	36	2	8	2
		7 <sup>th</sup>	253.6	309.6	48	2	8	1
		8 <sup>th</sup>	507.2	619.2	96	1	15	1
		9 <sup>th</sup>	951	1161	180	1	15	1
All Zones	Pb	1 <sup>st</sup>	21.8	30.0	2.0	2	8	2
		2 <sup>nd</sup>	43.7	60.0	3.9	2	8	2
		3 <sup>rd</sup>	65.8	90	5.9	2	8	2
		4 <sup>th</sup>	131	180	11.8	2	8	2
		5 <sup>th</sup>	262	360	23.6	2	8	2
		6 <sup>th</sup>	393	540	35.4	2	8	2
		7 <sup>th</sup>	524	720	47.2	2	8	1
		8 <sup>th</sup>	1048	1440	94.4	1	15	1
		9 <sup>th</sup>	1965	2700	177	1	15	1
All Zones	Zn	1 <sup>st</sup>	33.2	16.5	2.1	2	8	2
		2 <sup>nd</sup>	66.5	33.0	4.1	2	8	2
		3 <sup>rd</sup>	99.7	49.5	6.2	2	8	2
		4 <sup>th</sup>	199.4	99	12.4	2	8	2
		5 <sup>th</sup>	398.8	198	24.8	2	8	2
		6 <sup>th</sup>	598.2	297	37.2	2	8	2
		7 <sup>th</sup>	797.6	396	49.6	2	8	1
		8 <sup>th</sup>	1595.2	792	99.2	1	15	1
		9 <sup>th</sup>	2991	1485	186	1	15	1

Note – Maximum (MAXKEY) of 4 composites per drillhole

#### 14.1.9.2 Validation of Grade Estimate

Following grade estimation, a statistical and visual assessment of the block model was undertaken to 1) assess successful application of the estimation passes 2) to ensure that as far as the data allowed, all blocks within mineralisation domains were estimated and 3) the model estimates performed as expected. The model validation methods carried out included:

- On-screen visual assessment of composite and block model grades;
- SWATH plot (model grade profile) analysis; and
- Mean grade check.

##### i) On-Screen Check

An on-screen visual assessment of drill hole, composite and block model grades was carried out as shown in Figure 14.17. Visually the model was considered to spatially reflect the composite grades.

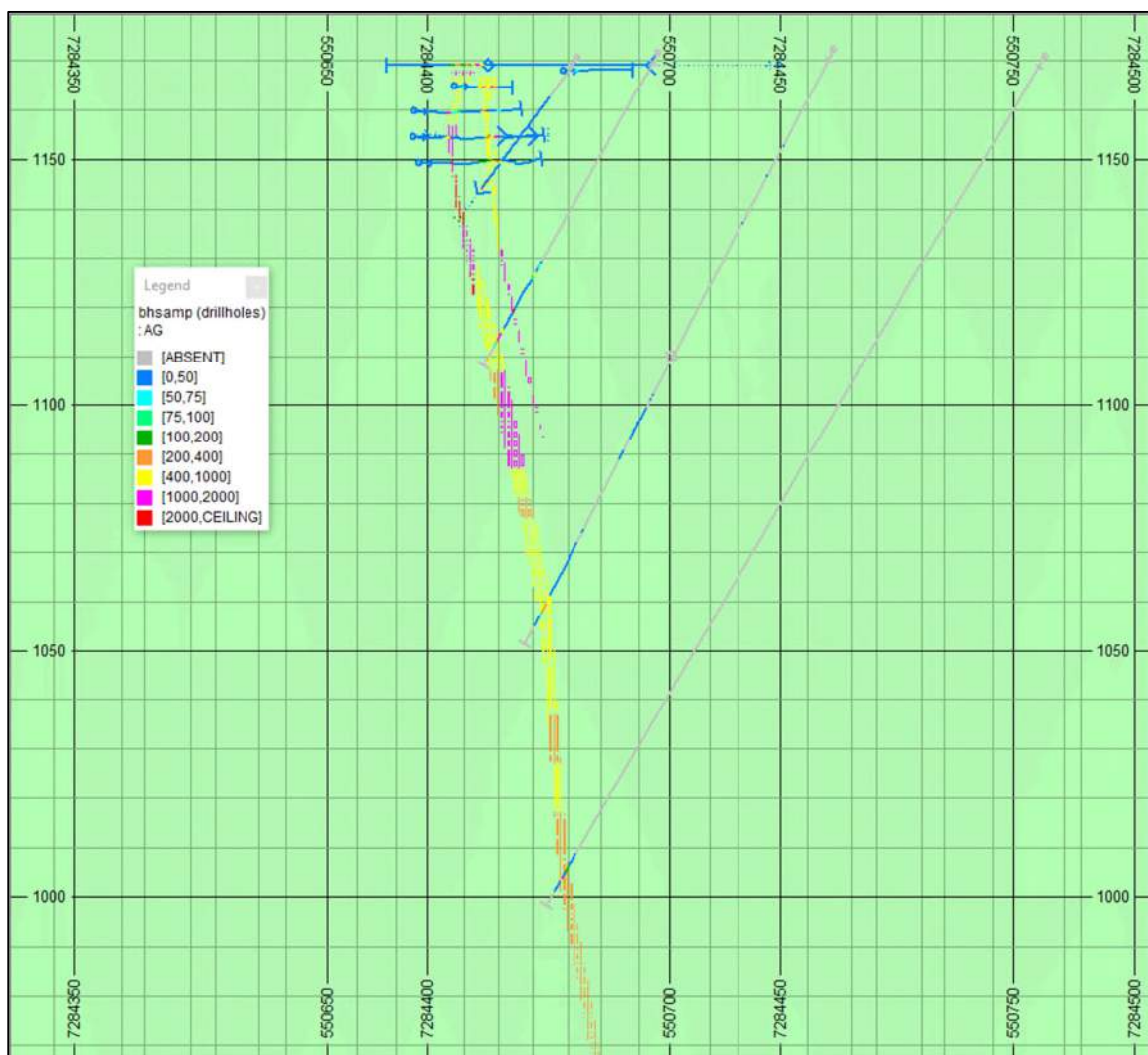
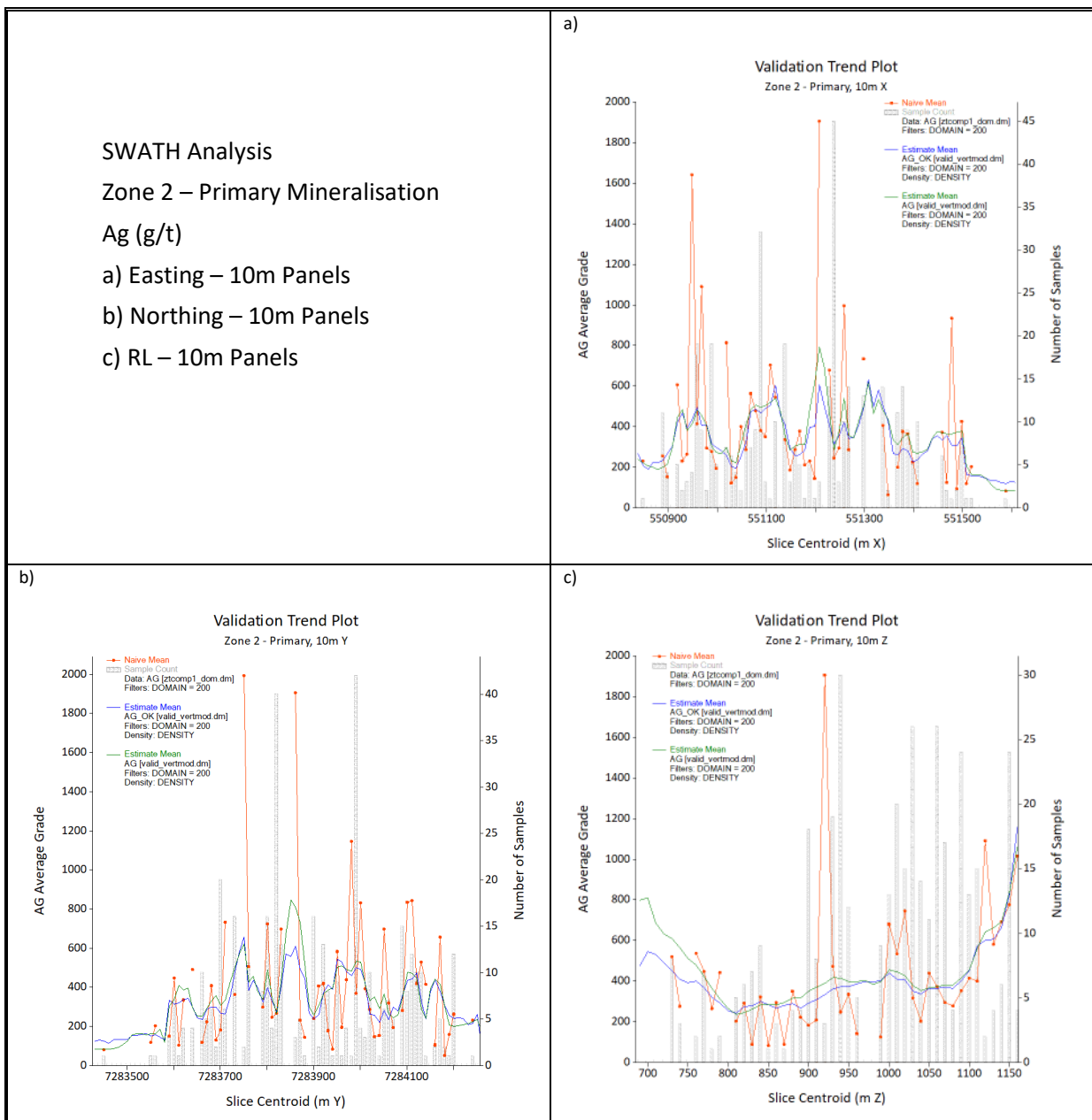


Figure 14.17: Example Cross-Section Comparing Drillhole and Block Model Ag Grades

ii) **SWATH Analysis**

Swath plots were generated from the model by averaging composites and blocks along panels. Swath plots were generated for all estimation methods and should exhibit a close relationship to the composite data upon which the estimation is based. An example Swath analysis for Ag for the primary mineralisation at Zone 2 is shown in Figure 14.18. The relationship between composite and block grades across the model is considered by WAI to be acceptable. Some deviations between the composite and estimated block grade occur at the edges of the deposit where reduced tonnages accentuate the differences in grade. Differences in grade also become more apparent in lower grade areas. These lower grade areas are typically where the density of drilling decreases and a few composites can have a disproportionate effect on the estimated grades.



**Figure 14.18: Example SWATH Analysis for Zone 2 - Primary Mineralisation**

**iii) Mean Grade Check**

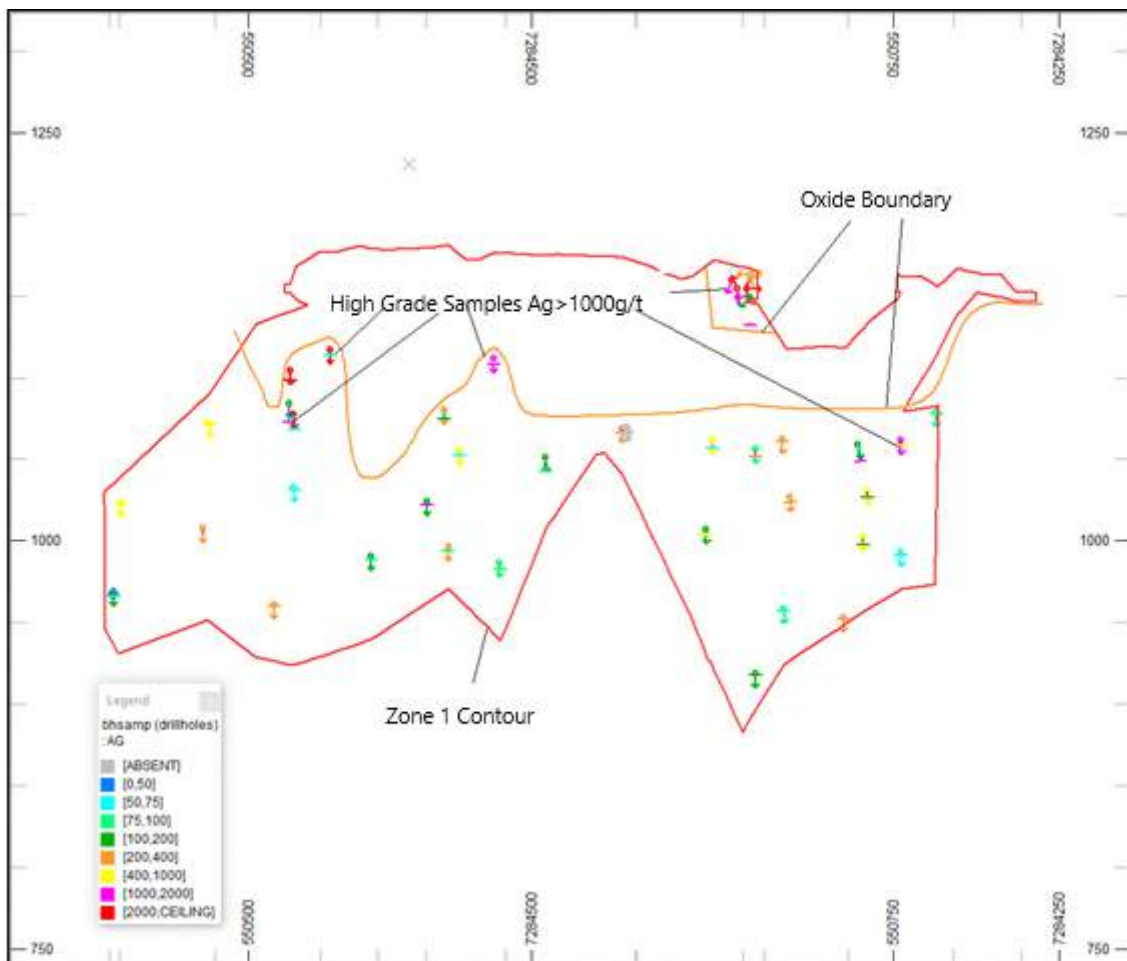
Statistical analysis of the block model was carried out for comparison against the composited drillhole data. This analysis provides a check on the reproduction of the mean grades of the composite data against the model over the global domain. Typically, the mean grade of each domain should not be significantly greater or less than the composites from which it has been derived. A comparison of the mean block model grades and mean composite grades for all domains is shown in Table 14.15. Where discrepancies between the composite mean grades and block model mean grades were observed, these were checked by WAI and seen to result from the spatial distribution of the data rather than errors in the grade estimation. Overall, WAI considers the composite grades and block model grades to be sufficiently comparable.

Type	ZONE	Tonnes (t)	Composites		Block Model
			No. of Samples	Mean	Mean
<b>Ag (g/t)</b>					
Oxide	1	298,217	927	985.26	955.03
	2	129,757	115	528.28	425.64
	3	8,313	2	224.00	224.00
	4	15,331	75	497.26	650.28
	5	908	13	257.10	365.57
	6	3,925	34	358.10	374.32
	7	-	-	-	-
	8	-	-	-	-
	9	-	-	-	-
Primary	1	379,435	150	1,004.53	660.38
	2	1,385,502	405	411.02	363.44
	3	371,952	53	475.82	485.34
	4	4,931	15	896.32	1,141.79
	5	-	-	-	-
	6	-	-	-	-
	7	14,617	5	646.16	610.17
	8	54,472	5	276.59	270.17
	9	34,941	8	226.74	241.96
<b>Pb (%)</b>					
Oxide	1	298,217	754	1.89	1.63
	2	129,757	106	1.66	1.27
	3	8,313	2	1.40	1.40
	4	15,331	64	1.15	1.21
	5	908	9	1.19	1.11
	6	3,925	32	3.13	2.89
	7	-	-	-	-
	8	-	-	-	-
	9	-	-	-	-
Primary	1	379,435	111	1.47	1.40
	2	1,385,502	271	1.76	1.95
	3	371,952	42	4.42	4.80
	4	4,931	15	1.22	1.88
	5	-	-	-	-
	6	-	-	-	-
	7	14,617	5	0.13	1.12
	8	54,472	5	5.32	5.46
	9	34,941	5	1.17	1.46
<b>Zn (%)</b>					
Oxide	1	298,217	754	1.77	1.73
	2	129,757	106	1.39	2.44
	3	8,313	2	0.37	0.37
	4	15,331	64	2.63	3.09
	5	908	9	1.28	1.15
	6	3,925	32	1.63	1.86
	7	-	-	-	-
	8	-	-	-	-
	9	-	-	-	-
Primary	1	379,435	111	1.90	2.02
	2	1,385,502	271	2.22	2.34
	3	371,952	42	1.31	1.36
	4	4,931	15	3.88	5.72
	5	-	-	-	-
	6	-	-	-	-
	7	14,617	5	0.28	1.50
	8	54,472	5	2.93	2.20
	9	34,941	5	0.96	1.95
Note – Block model grades based on OK estimates					

#### iv) Validation Summary

The comparison of composite and block model average grades shows significant difference between for Zone 1. Average silver grade for block model is 660.38g/t whereas average composite grade gives 1,004.53g/t.

The detailed analysis of data for primary mineralisation at Zone 1 shows the predominant locations of the high-grade intersections (i.e. above 1,000g/t) occurs on the relatively restricted area in the upper part of mineralization nearby oxide/primary mineralization boundary (Figure 14.19).



**Figure 14.19: Location of the High Grade Silver Composites (>1000g/t) for Primary mineralisation, Zone 1**

At the same time, the majority of the drillholes below the oxide boundary have grades of 350-400g/t. During grade interpolation into the block model the influence of the 'rich' samples is blocked by nearest relatively low-grade intersections.

Globally no indications of significant over or under estimation were apparent in the model nor were any obvious interpolation issues identified. From the perspective of conformance of the average model grade to the input data, WAI considers the model to be a satisfactory representation of the sample data used and an indication that the grade interpolation performed as expected. The Mineral Resource Estimate was based upon the OK grade estimation.

**14.1.10 Selective Mining Units**

No selective mining unit was applied at the resource stage. A minimum block size of 1m x 1m x 1m was however applied during block model construction. Mining selectivity, including mining dilution (planned and unplanned) and mining losses was incorporated during the mining study.

**14.1.11 Depletion of Mined-Out Resources**

Mineral resources were depleted by WAI based on an open pit mine survey supplied by the Client and dated 31 May 2019.

**14.1.12 Reconciliation**

CJSC Prognoz provided grade control and actual mining data for the period from November 2018 to July 2019 inclusive. In addition, the open pit survey data as of late October 2018 and late July 2019 was also provided. The grade control data was used by WAI for comparison with the WAI model. The WAI model was limited to the open pit surfaces as of October 2018 and July 2019 and the result of the comparison is given in Table 14.16.

<b>Table 14.16: Block Model vs Grade Control Data from October 2018 to July 2019 – Vertikalny</b>			
<b>Source</b>	<b>Tonnes, t</b>	<b>Grade, g/t</b>	<b>Silver, kg</b>
Grade control model	66,339.90	877.83	58,235.46
WAI model	61,024.72	996.78	60,828.42
<b>Absolute difference</b>	<b>5,315.18</b>	<b>-118.95</b>	<b>-2,592.95</b>
<b>Relative difference, %</b>	<b>109%</b>	<b>88%</b>	<b>96%</b>

Overall, the grade control model and the WAI model compare well with slightly higher tonnes and lower grades reporting from the grade control model. The difference in contained silver metal between the two models is approximately 4%.

**14.1.13 Mineral Resource Classification**

The Mineral Resource classification for the Vertikalny deposit was undertaken by WAI in accordance with the Australasian Code for Reporting of Exploration Results, Mineral Resources and Ore Reserves [JORC Code (2012)]. The principles governing the operation and application of the JORC Code are Transparency, Materiality and Competence:

- Transparency requires that the reader of a Public Report is provided with sufficient information, the presentation of which is clear and unambiguous, to understand the report and not be misled by this information.
- Materiality requires that a Public Report contains all the relevant information that investors and their professional advisers would reasonably require, and reasonably expect to find in the report, for the purpose of making a reasoned and balanced judgement regarding the Exploration Results, Mineral Resources or Ore Reserves being reported.
- Competence requires that the Public Report be based on work that is the responsibility of suitably qualified and experienced persons who are subject to an enforceable professional code of ethics.

#### *14.1.13.1 Considerations for Vertikalny Resource Classification*

To classify the Vertikalny deposit, WAI has taken into account the following indicators:

- Geological Continuity and Complexity;
- QAQC Results - Quality of Data;
- Spatial Grade Continuity - Results of Geostatistical Analysis; and
- Quality of Block Model.

WAI considers that silver, lead and zinc mineral resources can be classified as Measured, Indicated and Inferred.

#### **ii) Geological Continuity and Complexity**

With the current drill hole/trench spacing, geological continuity between exploration profiles both along strike and down dip is evident. The current drill hole spacing allows for interpretation of continuous zones of mineralisation based on the cut-off grade of 50g/t Ag.

#### **iii) Data Quality**

QA/QC results of exploration data show acceptable results when measuring accuracy, precision and contamination. This data can be used for estimation of mineral resources.

#### **iv) Spatial Grade Continuity**

An assessment of spatial grade continuity is important when assigning classification to a Mineral Resource. The confidence that can be placed in the variogram parameters is a major consideration when determining classification. The data used in geostatistical analysis resulted in reasonably robust along strike and down dip variogram structures for silver, lead, and zinc allowing the determination of the most appropriate search parameters.



**v) Block Model Veracity**

Validation of the block model has shown the estimated grades to be a good reflection of the input composite grades. Visual and statistical checks reveal no evidence of major under or over estimation.

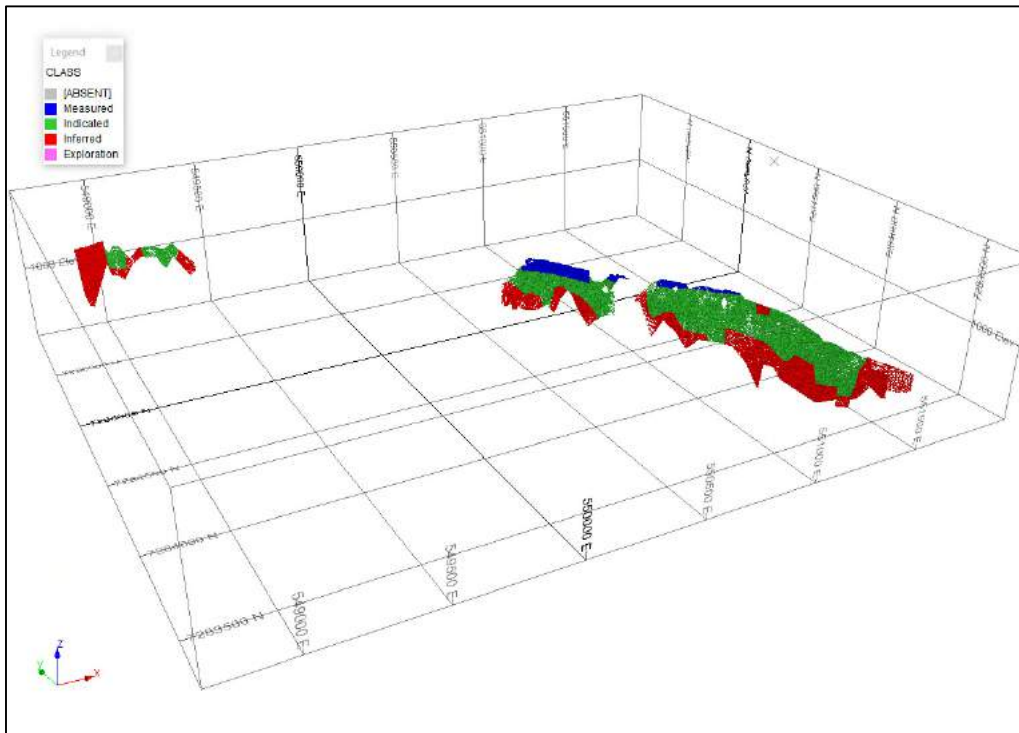
*14.1.13.2 Final Classification*

WAI considers that the Vertikalny Mine has been sufficiently explored to assign Measured, Indicated, and Inferred Mineral Resources as defined by JORC Code (2012).

Based on the geostatistical studies, and achieved drillhole spacing, the following criteria was used to define resource categories at Vertikalny.

- **Measured Mineral Resources** – belong to the interpreted principal mineralised zone, based on a drill grid of 40m by 40m along strike and down dip, where grade continuity is confirmed.
- **Indicated Mineral Resources** – belong to the interpreted principal mineralised zone, based on a drill grid of 80m by 80m along strike and down dip; the grade continuity can be confirmed.
- **Inferred Mineral Resources** – belong to the interpreted principal mineralised zone, based on a drill grid of >80m by 80m along strike and down dip; the grade continuity can be confirmed.

An isometric view of the block model Mineral Resource classification is shown in Figure 14.20.



**Figure 14.20: Unconstrained Block Model Classification**

**14.1.14 Reasonable Prospects for Economic Extraction**

For a deposit, or portion of a deposit, to be classified as a Mineral Resource there must be reasonable prospects for eventual economic extraction (the JORC Code [2012]). The model classified as described above was therefore further limited by economic parameters as described in this section.

The prospects for eventual economic extraction were tested by running an open pit optimisation using Datamine’s NPV Scheduler software and using the parameters listed in Table 14.17.

<b>Table 14.17: Optimisation Parameters for Constraining Open Pit Mineral Resources</b>			
<b>Parameter</b>	<b>Unit</b>	<b>Value</b>	<b>Comments</b>
Annual production rate – Mining and Processing	kt	115	SBR data
Operational costs for:			SBR data
<i>Ore mining</i>	US\$/t	2.53	SBR data
<i>Oxide ore processing</i>	US\$/t	72.91	SBR data
<i>Primary ore processing</i>	US\$/t	46.97	SBR data
G&A	US\$/t	60	SBR data
Metal Recovery	%	95	Tetra Tech data
Dilution	%	30	Tetra Tech data
Discount rate	%	8	WAI Estimate
Slope angle	Hanging wall	56	SRK data
Slope angle	Foot wall	48	SRK data
<i>Note – Processing cost includes cost processing cost itself and G&amp;A cost</i>			

Parameters used to constrain Mineral Resources for underground mining are given in Table 14.18 and the NSR calculation is shown in Table 14.19.

**Table 14.18: Parameters used to Constrain Underground Mineral Resources**

Parameter	Unit	Value	Comments
Operational costs for:			
<i>Ore mining</i>	US\$/t of ore	55	SBR data
<i>Processing of primary ore (tonnage of oxide ores is insignificant, the major type of mineralisation for underground is primary ore)</i>	US\$/t of ore	46.97	SBR data
G&A	US\$/t of ore	60	SBR data
NSR	US\$/t of ore	162	WAI estimate

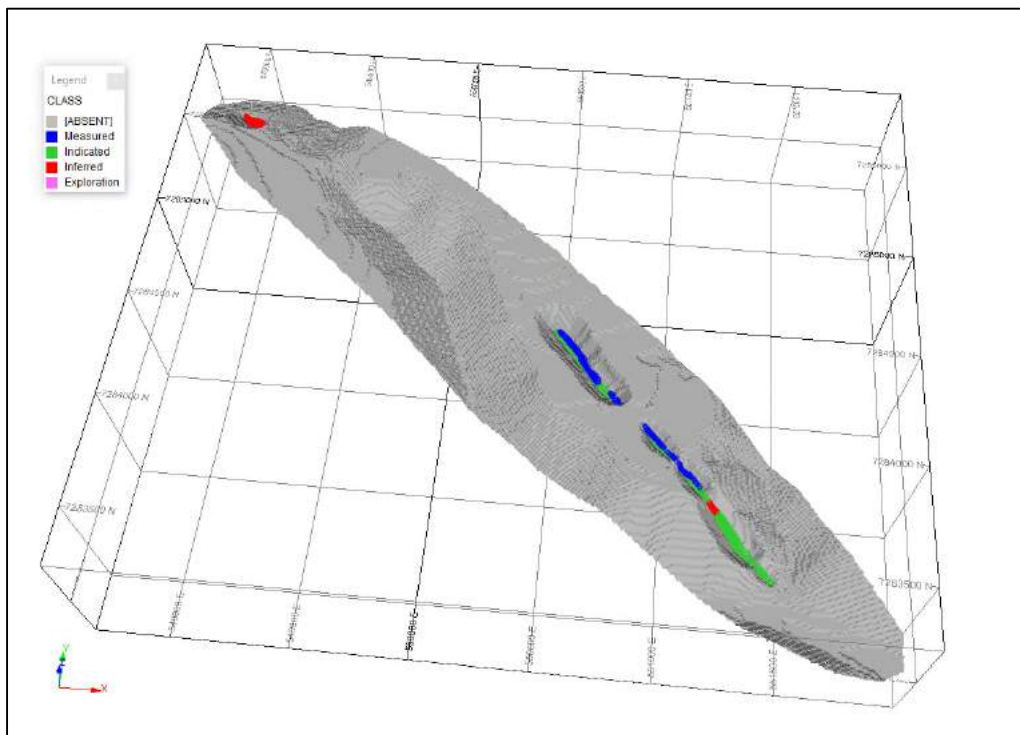
**Table 14.19: Data for NSR Calculation**

Parameter	Unit	SULPHIDE			OXIDE	Comment
		Zn Concentrate	Lead Concentrate	Pb/Ag Middlings		
Metal Prices						1.15x spot prices 27.08.19
Ag	US\$/oz	20.42	20.42	20.42	20.42	
Pb	US\$/t	2,379.35	2,379.35	2,379.35	2,379.35	5
Zn	US\$/t	2,589.80	2,589.80	2,589.80	2,589.80	0
Mill Recovery						SBR
Ag	%	4.7	65.0	15.6	85	
Pb	%	0	65.9	0	0	
Zn	%	82.2	0	0	0	
Concentrate Assay						SBR
Ag	g/t	Variable	Variable			
Pb	%	0.00	17.1			
Zn	%	42.3	0.00			
Moisture Content	%	0	0			Assumed 0%
Smelter Payment						SBR - Pb/Zn payability WAI Estimate - Ag Payability WAI Estimate - Deductions
Ag Payability	%	45	84	98	98	
Pb Payability	%	0	84	0	0	
Zn Payability	%	45	0	0	0	
Ag Deductions	g/t	0	0	0	0	
Pb Deductions	%	0	0	0	0	
Zn Deductions	%	0	0	0	0	
Treatment Charge/Refining Charge						SBR
Transport	US\$/tconc	274.9	274.9	0	0	
Treatment	US\$/tconc	0	0	0	0	
Refining (Ag)	US\$/tOz	0.48	0.48	0.48	0.48	
NSR Factor						
Ag	US\$/g/t <sub>ore</sub>	0.46				
Pb	US\$/%/t <sub>ore</sub>	2.58				
Zn	US\$/%/t <sub>ore</sub>	4.24				

NSR cut-off values were used to evaluate the Mineral Resources based on mineralisation type and open pit/underground mining methods as shown in Table 14.20. It should be noted that the amount of oxide mineralisation for underground mining is insignificant and therefore only primary mineralisation has been considered for underground mining. The higher NSR cut-off value for open pit mining of oxide compared to primary is due to a higher processing cost of oxide.

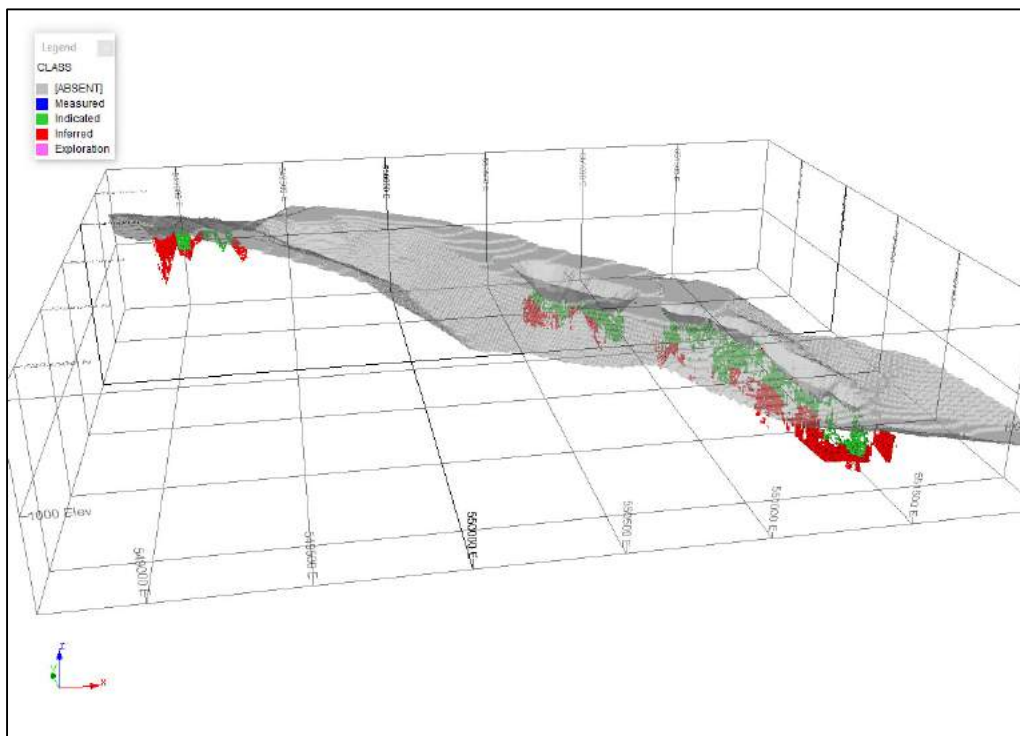
Method	Mineralisation Type	Unit	NSR
Open pit mining	Oxide	US\$/t	172.78
Open pit mining	Primary	US\$/t	139.06
Underground mining	Primary	US\$/t	162.00

Open pit Mineral Resources limited by the optimised pit shell are shown in Figure 14.21.



**Figure 14.21: Mineral Resources for Open Pit Mining**

Underground Mineral Resources located below the base of the optimised pit shell and above the NSR cut-off value of \$130/t are shown in Figure 14.22.



**Figure 14.22: Mineral Resources for Underground Mining**

#### **14.1.15 Mineral Resource Statement**

The Mineral Resource estimate for the Vertikalny deposit is classified in accordance with the Australasian Code for Reporting of Exploration Results, Mineral Resources and Ore Reserves [JORC Code (2012)].

The stated Mineral Resources are not materially affected by any known environmental, permitting, legal, title, taxation, socio-economic, marketing, political or other relevant issues, to the best knowledge of the author. There are no known mining, metallurgical, infrastructure, or other factors that materially affect this Mineral Resource Estimate currently.

The effective date of the Mineral Resource Estimate is 31<sup>st</sup> of May 2019.

The Mineral Resource statement for the open pit resources at Vertikalny is shown in Table 14.21.

The Mineral Resource statement for the underground resources at Vertikalny are shown in Table 14.22.

Ag Cut-off, g/t	Category	Tonnes, Kt	Ag, g/t	Pb, %	Zn, %	Ag, kg	Pb, t	Zn, t
200	<b>Oxide</b>							
	Measured	94.90	949.88	2.01	1.58	90,141	1,909	1,500
	Indicated	89.24	1,181.88	1.33	1.92	105,469	1,190	1,710
	<b>Sub-Total M+I</b>	<b>184.14</b>	<b>1,062.32</b>	<b>1.68</b>	<b>1.74</b>	<b>195,610</b>	<b>3,099</b>	<b>3,211</b>
	<b>Primary</b>							
	Measured	13.19	1,328.95	1.85	1.96	17,524	244	258
	Indicated	36.14	1,830.08	2.28	1.42	66,148	825	514
	<b>Sub-Total M+I</b>	<b>49.33</b>	<b>1,696.13</b>	<b>2.17</b>	<b>1.56</b>	<b>83,672</b>	<b>1,069</b>	<b>772</b>
	<b>Oxide + Primary</b>							
<b>Total M+I</b>	<b>233.47</b>	<b>1,196.24</b>	<b>1.79</b>	<b>1.71</b>	<b>279,282</b>	<b>4,168</b>	<b>3,983</b>	

**Notes:**

1. Mineral Resources are reported in accordance with the guidelines of the JORC Code (2012).
2. Mineral Resources are not Ore Reserves until they have demonstrated economic viability based on a feasibility study or pre-feasibility study.
3. Mineral resources include all potential mineable tonnage.
4. Mineral Resources are estimated as of 31 May 2019 based on an open pit mine survey of the same date.
5. Mineral Resources were constrained by an optimised pit shell using a NSR cut-off value of \$172.78/t for oxide and \$139.06/t for primary mineralisation.
6. Mineral Resources were constrained by an optimised pit shell based on economic and mining parameters provided by the Client and/or accepted by WAI.
7. This mineral resource estimate is not limited to any factors in terms of environmental, permitting, legal, title, taxation, socio-economic, market and other relevant factors.
8. The metal resources include all the in-situ metal disregard the metallurgical recovery factor.
9. All values in the tables have been rounded with relative accuracy of estimate.
10. Numbers may not compute due to rounding.

Ag Cut-off, g/t	Category	Tonnes, Kt	Ag, g/t	Pb, %	Zn, %	Ag, kg	Pb, t	Zn, t
300	Measured	0.29	581.70	2.66	0.58	166	8	2
	Indicated	235.82	680.72	1.26	2.57	160,524	2,964	6,059
	<b>M+I</b>	<b>236.10</b>	<b>680.60</b>	<b>1.26</b>	<b>2.57</b>	<b>160,690</b>	<b>2,972</b>	<b>6,061</b>
	Inferred	109.42	538.93	1.26	1.75	58,970	1,378	1,919

**Notes:**

1. Mineral Resources are reported in accordance with the guidelines of the JORC Code (2012).
2. Mineral Resources are not Ore Reserves until they have demonstrated economic viability based on a feasibility study or pre-feasibility study.
3. Mineral resources include all potential mineable tonnage.
4. Mineral Resources are estimated as of 31 May 2019 based on an open pit mine survey of the same date.
5. Mineral Resources are located below an optimised pit and were evaluated based on an NSR cut-off value of \$162.00/t for primary mineralisation.
6. Economic and mining parameters provided by the Client and/or accepted by WAI were incorporated in the calculation of NSR.
7. This mineral resource estimate is not limited to any factors in terms of environmental, permitting, legal, title, taxation, socio-economic, market and other relevant factors.
8. The metal resources include all the in-situ metal disregard the metallurgical recovery factor.
9. All values in the tables have been rounded with relative accuracy of estimate.
10. Numbers may not compute due to rounding.

#### 14.1.15.1 Comparison to Previous Mineral Resource Estimates

A mineral resource estimate was undertaken by OREALL in 2019 as part of a TEO study of cut-off criteria. The estimation was carried out using geological blocks for 50, 75, 150, and 250g/t Ag COG. Mineral resources were estimated by OREALL for both open pit and underground mining scenarios. It is understood that the estimate by OREALL was not signed off as being in accordance with any international reporting standards e.g. JORC. The most suitable option for comparison is using a 50g/t Ag cut-off grade as WAI used the same cut-off grade to model the mineralised wireframes.

The comparison included mined-out material as this was included in the OREALL estimate. The WAI estimate used the optimised open pit shell from the MRE. The results of comparison are shown in Table 14.23. The two estimates are considered comparable.

<b>Table 14.23: OREALL MRE (2019) vs WAI MRE (2019) (Cut-Off Grade of 50g/t Ag)</b>				
<b>Source</b>	<b>Mineral resources</b>	<b>Tonnes (kt)</b>	<b>Grade (g/t)</b>	<b>Silver (kg)</b>
OREALL	Within the open pit shell	726	705	511,503
OREALL	Below the open pit shell	1,858	397	738,091
<b>OREALL</b>	<b>Total</b>	<b>2,583</b>	<b>484</b>	<b>1,249,594</b>
WAI	Within the open pit shell	733	794	582,197
WAI	Below the open pit shell	1,974	371	732,053
<b>WAI</b>	<b>Total</b>	<b>2,707</b>	<b>485</b>	<b>1,314,250</b>
<b>Difference (%)</b>		<b>+5%</b>	<b>0%</b>	<b>+5%</b>

## 14.2 Mineral Resources Estimate – Mangazeisky North

### 14.2.1 General Methodology

The following section describes the process of Mineral Resource estimation of the Mangazeyskiy North silver deposit. The estimate has been carried out in accordance with the guidelines of the JORC Code (2012).

The Mineral Resource Estimate (MRE) was carried out with a 3D block modelling approach using Datamine Studio 3 software (Datamine). Exploration data were imported and verified before being used for modelling mineralised wireframes. Besides, digital surface models, mining boundaries, overburden surface, and contours/boundaries of oxide and primary material were imported and/or created. Sample data were selected within mineralisation wireframes and their populations were assessed for outliers. The wireframe envelopes were used as the basis for a volumetric block model based on a parent cell size of 10m x 10m x 10m. Variogram models were constructed based on composite data and used for grade interpolation using Ordinary Kriging (OK) and Inverse Power of Distance methods. The resultant estimated grades were validated against the input samples and composites. The mineralisation was classified in accordance with the guidelines of the JORC Code (2012) and based on an assessment of geological and silver grade continuity of the mineralised zones. Mineral Resources were defined according to the expectation of eventual economic extraction by being constrained within an optimised open pit shell generated using NPV Scheduler and underground

stopes optimised using Mineable Shape Optimiser module of Datamine Studio 5D Planner, based on appropriate economic and technical parameters.

## **14.2.2 Data Transformations and Software**

### *14.2.2.1 Data Transformations*

All data are stored using the same local co-ordinate system and the same unit convention based on the WGS84 system. Therefore, transformations of drillhole or other data were not required.

### *14.2.2.2 Software*

The MRE has relied on several software packages for the various stages of the process. However, the main data preparation and validation, wireframe modelling, statistical and geostatistical analysis, block modelling, estimation and validation were performed in Datamine Studio 3 version 3.22.84.0.

## **14.2.3 Database**

### *14.2.3.1 Exploration Database*

#### ***i) Input Data***

The structure of the Mangazeisky North database is similar to that of Vertikalny. Exploration database for the period from 2004 to 2016 was supplied by the Client in MS Access and Excel format with separate files for collar/trench starting point, downhole survey for drill holes and bearing/dip for trenches, and assay. An excel file was also provided with codes of lithologies and petrography for both ore and waste, together with their oxidation degree. The relevant imported data in each of these files are listed in Table 14.24.

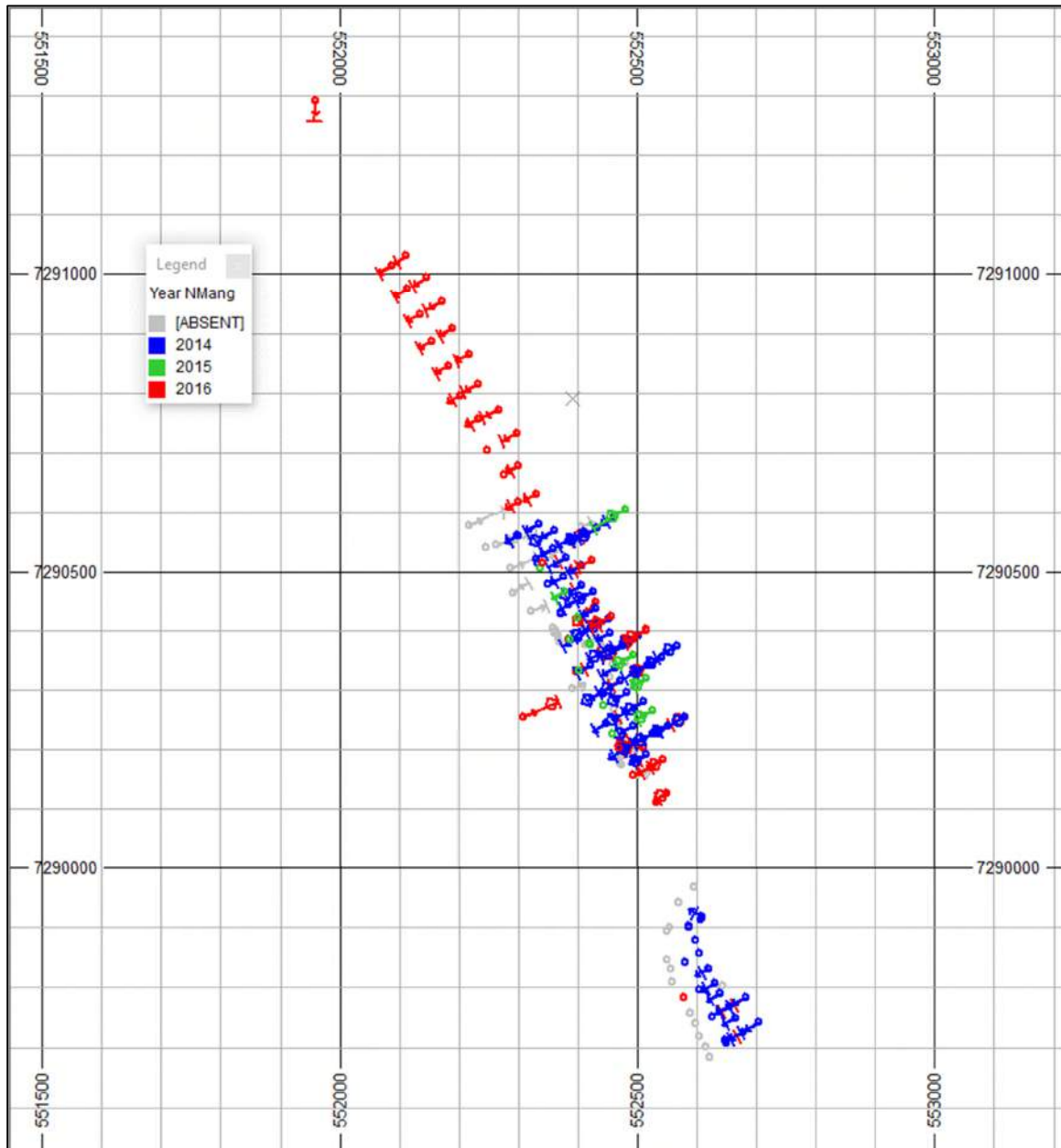


<b>Table 14.24: Information in Exploration Database Files</b>					
<b>Collar File</b>		<b>Assay File</b>		<b>Survey File</b>	
<b>Column</b>	<b>Explanation</b>	<b>Column*</b>	<b>Explanation</b>	<b>Column</b>	<b>Explanation</b>
Project	Exploration area	Project	Exploration area	Project	Exploration area
Hole	drill hole/trench ID No.	Hole	ID No. of drill hole/trench	Hole	drill hole/trench ID No.
Length	Depth/length of drill hole/trench	From_m	Interval from	Depth	Глубина замера
UTM_Grid	Coordinate system	To_m	Interval to	Dip	Inclination angle
UTM_East	Collar easting	DHSample	Sample No.	Measured_Azimuth	Bearing of drill hole/trench
UTM_North	Collar northing	Sample_Type	Sample type	<b>Lithology file</b>	
UTM_Elevation	Collar elevation	Primary_Sample	Original sample No. for duplicates	Project	Exploration area
Azimuth	Bearing of drill hole/trench	Au_OL_ppm	Au, g/t	Hole	drill hole/trench ID No.
Dip	Inclination angle	Ag_OL_ppm	Ag, g/t	From_m	Interval from
Hole_Type	Type of drill hole/trench	Cu_OL_pct	Cu, %	To_m	Interval to
Drill_Rig	Drill rig details	Pb_OL_pct	Pb, %	Lith1	Rock code
Timestamp	Closure date	Zn_OL_pct	Zn, %	Lith1_Oxidation	Oxidation degree
		* assay data for 32 elements are not included into the estimate			

#### 14.2.3.2 Database Summary

A summary of the exploration database for Mangazeisky North is shown in Table 14.25. The database includes the surface diamond drill holes and trenches completed as part of the geological exploration phase. The trenches were excavated during the period from 2004 to 2015, the drilling was undertaken between 2005 and 2016. The locations of drill hole collars by years and trenches completed at the exploration phase is shown on Figure 14.23.

<b>Table 14.25: Summary of Database</b>		
<b>Exploration types</b>	<b>Number</b>	<b>Total length, m</b>
Drill holes	157	7,096.80
Trenches	50	566.60
<b>Total</b>	<b>207</b>	<b>7,663.40</b>



**Figure 14.23: Locations of drill hole collars and trenches completed at the exploration phase. Trenches as shown in grey and the drill holes are shown according to the legend.**

**ii) Database Processing**

The individual geological exploration and grade control database files were imported into Datamine. The data from the files then were desurveyed in accordance with the coordinates, downhole survey, assay data and lithologies. Verification was carried out during the desurveying process to ensure that no duplicate or overlapping samples were included in the final database.

Collar locations were checked against the current or pre-mining topographic surfaces and were found to be consistent. Deviation of downhole surveys was checked to ensure that no significant deviations were recorded.

Distribution of samples, where assay detected silver grades, between the exploration types is shown in Table 14.26.

Exploration types	No. of samples	% of total No. of samples
Drill holes	2,514	83%
Trenches	513	17%
<b>Total</b>	<b>3,027</b>	<b>100%</b>

#### **14.2.4 Wireframe Modelling**

##### *14.2.4.1 Introduction*

Prognoz CJSC provided topographical survey in AutoCAD format, which was then used to create a digital terrain model (DTM). In addition, WAI also modelled the overburden based on drill hole logging data.

WAI made an attempt to model the boundary of the oxide zone based on trench and drill hole geological logging data. However, the provided data contained contradictory information, where mineralised intervals in adjacent holes/trenches were different mineralisation types, and intervals within one mineralised intersection were often assigned different oxidation degree (from primary to oxide material types).

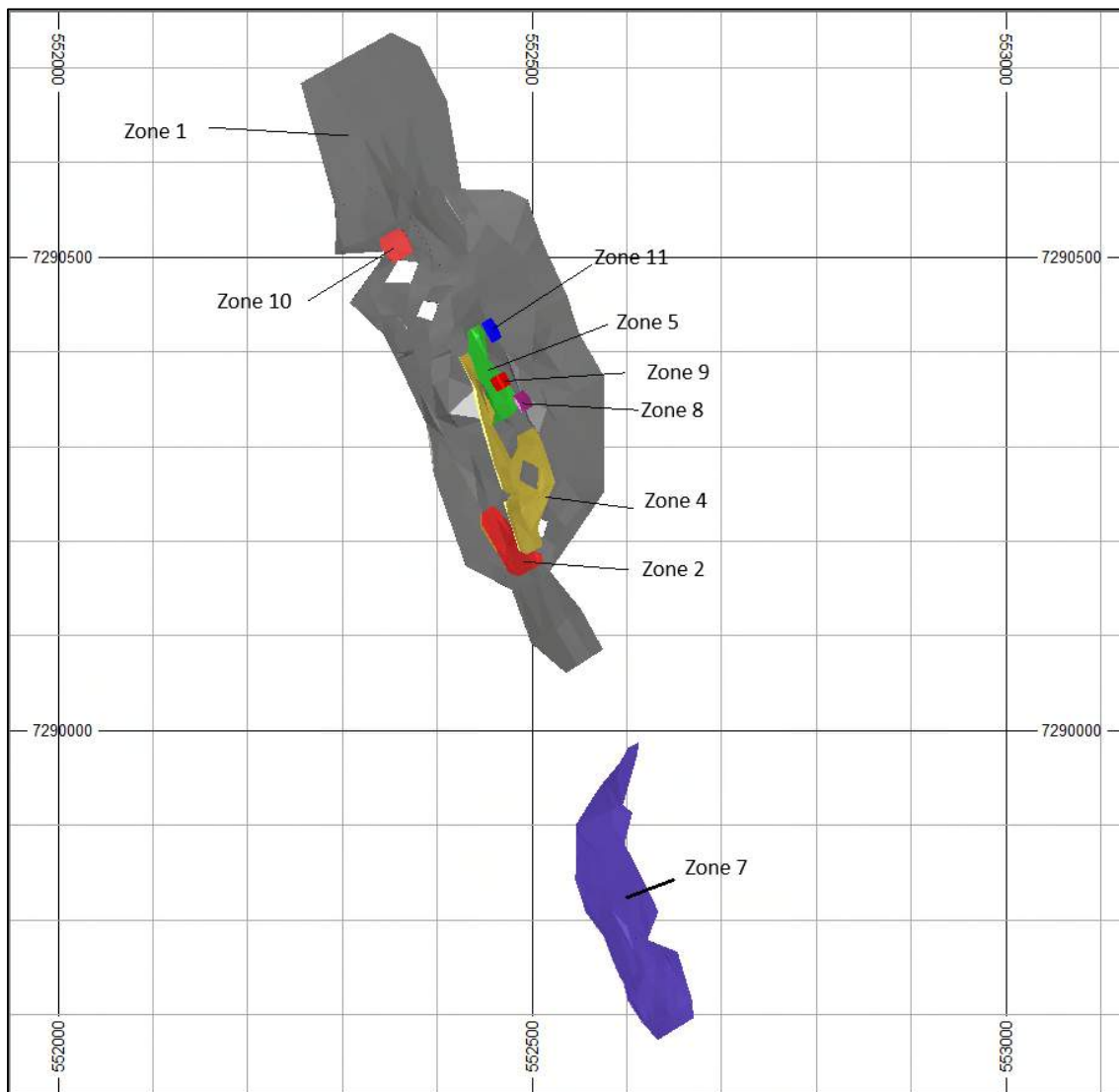
##### *14.2.4.2 Mineralised Wireframe Modelling*

The mineralised wireframe modelling for Mangazeisky was based on the same cut-off parameters as for Vertikalny:

- Cut-off grade – 50g/t Ag;
- Minimum mineralised interval included into wireframe model – 1m;
- Maximum waste interval included into the mineral wireframe – 3m.

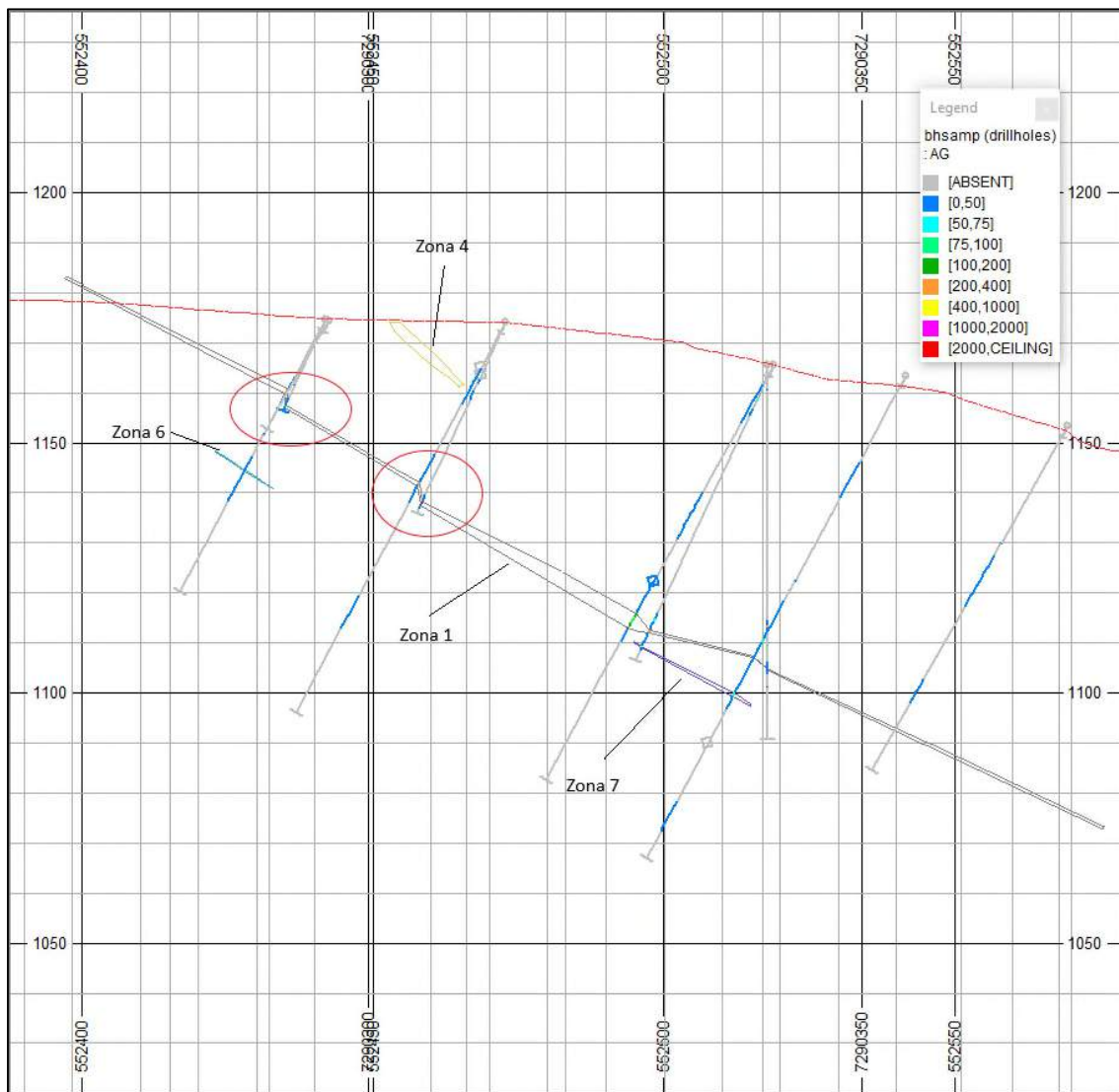
It should be noted that both the thickness and the grade of the mineralisation both at Vertikalny and Mangazeisky has a significantly variable nature, and in order to maintain continuity and consistency of mineralisation and in order to maintain mineralised continuity, and/or to avoid a redundant splitting of mineralised intervals, there was some flexibility permitted in the parameters listed above.

As a result, a total of 17 individual mineralised zones were modelled at Mangazeisky (Figure 14.24), including three major zones – Zone 1 and Zone 3 in the central part and Zone 17 in the south-eastern part of the deposit. The other zones have insignificant extent and are intersected by holes/trenches in 1-3 up to 4 exploration profiles. Minor mineralisation zones are located mainly above main zone 1 and also below this zone. The mineralised zones have north-west strike (bearing 330-340°), dip angle is 30-40° northeast.



**Figure 14.24: Mineralized Zone Wireframe Models for Mangazeisky North. Some zones are below Zone 1**

Modeling made it clear that the location of drillhole collars and/or deviation survey data need to be refined for some close drillholes since there is an abrupt change in the mineralized occurrence at a relatively short distance (Figure 14.25)



**Figure 14.25: Section crossing the Mineralized Wireframes. Highlighted areas with abrupt changes in the mineralized occurrence in the near holes**

### 14.2.5 Statistical Analysis and Variogram Modelling

#### 14.2.5.1 General Statistics

WAI has coded individual wireframes for different zones and completed a general statistical analysis on the number of drillholes/trenches, samples, and composites for individual zones as summarised in Table 14.27. The average length of the samples is 0.58m therefore the composite length of 1.0m was chosen for Mangazeisky North (Table 14.27).

Zone	Exploration type	Number of			Total, m	Average length, m
		Drill holes/trenches	samples	composites		
1	Trenches	10	30	26	24.90	0.83
1	Drill holes	80	207	143	109.95	0.53
2	Trenches	4	13	8	7.45	0.57
2	Drill holes	6	8	7	3.70	0.46
3	Drill holes	3	4	4	2.85	0.71
4	Drill holes	5	10	8	6.55	0.66
4	Trenches	12	41	30	26.40	0.64
5	Drill holes	6	11	8	6.00	0.55
6	Drill holes	2	3	2	0.90	0.30
7	Drill holes	2	2	2	1.20	0.60
8	Trenches	1	4	4	4.00	1.00
9	Drill holes	2	3	3	2.50	0.83
10	Drill holes	1	2	2	1.60	0.80
11	Drill holes	1	2	2	2.00	1.00
12	Drill holes	1	2	1	0.40	0.20
13	Drill holes	2	2	2	0.60	0.30
14	Drill holes	7	17	13	10.25	0.60
15	Drill holes	1	3	2	2.30	0.77
16	Drill holes	1	2	1	0.30	0.15
17	Trenches	11	24	17	15.10	0.63
17	Drill holes	20	30	24	15.13	0.50
<b>Trenches total</b>		<b>38</b>	<b>112</b>	<b>85</b>	<b>77.85</b>	<b>0.70</b>
<b>Drill holes total</b>		<b>140</b>	<b>308</b>	<b>224</b>	<b>166.23</b>	<b>0.54</b>
<b>Trenches/drill holes total</b>		<b>178</b>	<b>420</b>	<b>309</b>	<b>244.08</b>	<b>0.58</b>
<i>- the total number of drill holes/trenches is 207, however, some of these did not hit mineralisation, and some of the drill holes/trenches intersect more than one zone.</i>						

The general statistics for composites within mineralised wireframes are presented in Table 14.28. The average copper grade is very low and is close to the detection limit of most of the analytical methods. The average lead grade is significantly higher than at Vertikalny, while the average zinc grade is more than two times lower than at Vertikalny.

Metal	Composite No.	Minimum	Maximum	Count	Mean	Variance	Standard Deviation	Standard Error	Variance factor
Ag	309	0.0005	3,410.00	191,293.73	619.07	516,866.31	718.93	40.90	233%
Pb	309	0.005	48.02	1,598.73	5.17	66.02	8.13	0.46	3%
Zn	309	0.00185	37.06	200.14	0.65	14.47	3.80	0.22	1%
Cu	309	0	0.09	3.84	0.01	0.00021	0.01	0.0008	0%

Statistical parameters for the main metals (Ag, Pb and Zn) within the wireframes of individual mineralised zones are given in Table 14.29.

**Table 14.29: Statistical Parameters for Composites within Individual Zones**

Zone	Metal	Composite No.	Minimum	Maximum	Mean	Variance	Standard Deviation	Standard Error	Variance factor
1	AG	169	0.0005	3,410.00	653.79	570,470.41	755.29	58.10	116%
1	PB	169	0.005	48.02	6.77	87.46	9.35	0.72	138%
1	ZN	169	0.002	32.05	0.62	12.19	3.49	0.27	564%
2	AG	15	61	1,670.24	511.54	266,482.98	516.22	133.29	101%
2	PB	15	0.027	8.43	1.80	8.82	2.97	0.77	165%
2	ZN	15	0.01	1.22	0.20	0.09	0.30	0.08	152%
3	AG	4	80.9	419.00	219.23	15,248.10	123.48	61.74	56%
3	PB	4	1.314	8.81	4.37	7.66	2.77	1.38	63%
3	ZN	4	0.085	0.17	0.13	0.00	0.03	0.02	27%
4	AG	38	42.28	2,166.00	539.06	285,648.67	534.46	86.70	99%
4	PB	38	0.01	4.29	0.48	1.01	1.00	0.16	208%
4	ZN	38	0.00185	0.33	0.05	0.00	0.07	0.01	148%
5	AG	8	98.7	803.35	303.73	48,162.31	219.46	77.59	72%
5	PB	8	0.06	12.46	3.97	12.66	3.56	1.26	90%
5	ZN	8	0.039	0.31	0.15	0.01	0.09	0.03	60%
6	AG	2	1360	2,698.00	2 029.00	447,561.00	669.00	473.05	33%
6	PB	2	21.746	30.00	25.87	17.03	4.13	2.92	16%
6	ZN	2	0.602	0.75	0.67	0.01	0.07	0.05	11%
7	AG	2	97.2	771.00	434.10	113,501.61	336.90	238.22	78%
7	PB	2	1.264	23.60	12.43	124.72	11.17	7.90	90%
7	ZN	2	0.085	0.09	0.09	0.00001	0.00350	0.00247	4%
8	AG	4	79.6	334.00	235.65	9,868.37	99.34	49.67	42%
8	PB	4	0.1	0.10	0.10				
8	ZN	4	0.01	0.05	0.02	0.00	0.02	0.01	71%
9	AG	3	79.6	144.20	108.93	713.13	26.70	15.42	25%
9	PB	3	1.724	4.99	3.34	1.78	1.33	0.77	40%
9	ZN	3	0.096	0.13	0.11	0.00	0.02	0.01	13%
10	AG	2	61.5	274.65	168.08	11,358.23	106.58	75.36	63%
10	PB	2	0.266	5.52	2.89	6.89	2.63	1.86	91%
10	ZN	2	0.2148	0.22	0.22	0.00	0.00	0.00	1%
11	AG	2	62.5	3,150.00	1,606.25	2,383,164.06	1,543.75	1,091.60	96%
11	PB	2	1.238	21.82	11.53	105.85	10.29	7.28	89%
11	ZN	2	0.111	0.68	0.40	0.08	0.28	0.20	72%
12	AG	1	237.6	237.60	237.60				
12	PB	1	1.2	1.20	1.20				
12	ZN	1	0.28	0.28	0.28				
13	AG	2	77	2,380.90	1,228.95	1,326,988.80	1,151.95	814.55	94%
13	PB	2	0.08	1.70	0.89	0.66	0.81	0.57	91%
13	ZN	2	0.366	37.06	18.71	336.61	18.35	12.97	98%
14	AG	13	109	1,619.20	472.68	186,468.96	431.82	119.77	91%
14	PB	13	0.22	22.50	6.78	34.99	5.92	1.64	87%
14	ZN	13	0.0678	32.98	2.74	76.22	8.73	2.42	318%
15	AG	2	140	1,332.50	736.25	355,514.06	596.25	421.61	81%
15	PB	2	0.229	13.28	6.76	42.61	6.53	4.62	97%
15	ZN	2	0.1104	0.12	0.12	0.00	0.01	0.00	5%
16	AG	1	1968	1,968.00	1,968.00				
16	PB	1	15.169	15.17	15.17				
16	ZN	1	0.469	0.47	0.47				
17	AG	41	55.9	3,035.20	666.20	569,064.77	754.36	117.81	113%
17	PB	41	0.01	30.00	3.03	30.84	5.55	0.87	183%
17	ZN	41	0.007	2.05	0.29	0.16	0.40	0.06	139%

#### 14.2.5.2 Comparison of Statistics between Drill Holes and Trenches

Grade statistics for main metals for both drill holes and trenches are given in Table 14.30. The average silver grade for trenches is higher than that for the drill holes. However, the number of composites in drill hole is almost three times higher than in trenches. At the same time, the maximum silver grades for both trenches and drill holes are comparable. The average grades of lead and zinc are significantly lower in trenches than in drill holes and maximum grades of these metals in trenches have very low values.

**Table 14.30: Statistics of Composites separately for Drill Holes and Trenches**

Drill hole/trench	Metal	No. of composites	Grade		
			Min	Max	Av
Drill holes	AG	224	2.10	3,410.00	550.06
Drill holes	PB	224	0.01	48.02	7.10
Drill holes	ZN	224	0.016	37.06	0.89
Trenches	AG	85	0.0005	3,283.00	800.93
Trenches	PB	85	0.005	0.10	0.09
Trenches	ZN	85	0.002	0.07	0.02

#### 14.2.5.3 Top Cutting

Similarly to Vertikalny, the need for top cutting and top cut values in the composites were analyzed for individual zones of Mangazeisky North using a quantile / decile analysis of grades and probability plots.

It should be noted that only three zones (Zones 1, 4 and 17) had populations of composites where their total number exceeded 30 values and top cut analysis was undertaken for these three zones only. The populations for other mineralised zones are insufficient for such analysis.

Table 14.31 shows a quantile analysis of silver grades for zones 1, 4 and 17. Each of the percentiles in the upper quantile (90-100%) for Zone 1 contains less than 6% of accumulated metal. Upper quantile for Zone 4 contains only 4 samples, where the accumulated metal contained is close to 30%. In WAI opinion, top cutting is not required for these zones.

The estimated limit value for silver for Zone 17 is 2,000g/t, however, these samples are spatially located in the near-surface area and are concentrated in one area (Figure 14.26). WAI believes that this can indicate the peculiarities of the developed mineralization in Zone 17 and no top cutting is required.

Examples of probability plots for Zones 1, 4 and 17 for silver are shown in Figure 14.27, Figure 14.28, and Figure 14.29.



**Table 14.31: Quantile Analysis of Silver Grades for Individual Zones**

Zone	Q%_from	Q%_to	Qty of samples	Ave	Min	Max	Accumulated metal	Accumulated metal (%)
1	0	10	17	45.5	2.1	71.1	773.57	0.69
1	10	20	17	88.13	74.9	105.06	1 498.27	1.34
1	20	30	17	137.24	106	167.5	2 333.13	2.09
1	30	40	17	198.37	170.17	230	3 372.30	3.02
1	40	50	17	265.75	241.33	303	4 517.83	4.04
1	50	60	17	390.55	326	463.72	6 639.35	5.94
1	60	70	17	551.12	464.2	665	9 369.05	8.38
1	70	80	17	960.61	703.7	1 195.50	16 330.36	14.61
1	80	90	17	1 389.22	1 197.35	1 650.00	23 616.77	21.13
1	90	100	18	2 408.00	1 653.00	3 410.00	43 344.00	38.77
1	90	91	1	1 653.00	1 653.00	1 653.00	1 653.00	1.48
1	91	92	2	1 747.60	1 745.20	1 750.00	3 495.20	3.13
1	92	93	2	1 888.00	1 880.00	1 896.00	3 776.00	3.38
1	93	94	2	2 089.60	2 010.00	2 169.20	4 179.20	3.74
1	94	95	2	2 293.50	2 262.00	2 325.00	4 587.00	4.1
1	95	96	1	2 450.00	2 450.00	2 450.00	2 450.00	2.19
1	96	97	2	2 517.50	2 455.00	2 580.00	5 035.00	4.5
1	97	98	2	2 620.30	2 620.00	2 620.60	5 240.60	4.69
1	98	99	2	3 117.50	3 015.00	3 220.00	6 235.00	5.58
1	99	100	2	3 346.50	3 283.00	3 410.00	6 693.00	5.99
1	0	100	171	653.77	2.1	3 410.00	111 794.63	100
4	0	10	3	53.73	42.28	65.7	161.18	0.85
4	10	20	4	101.42	80.6	111	405.67	2.13
4	20	30	4	119.69	112.5	123.8	478.76	2.51
4	30	40	4	146.85	126	180.4	587.4	3.08
4	40	50	4	221.74	186	268.54	886.94	4.65
4	50	60	3	331.43	271	368.28	994.28	5.21
4	60	70	4	403.9	370	444.8	1 615.60	8.47
4	70	80	4	724.38	484	926.44	2 897.52	15.2
4	80	90	4	1 134.25	952.5	1 231.00	4 537.01	23.79
4	90	100	4	1 625.77	1 364.00	2 166.00	6 503.06	34.11
4	92	93	1	1 364.00	1 364.00	1 364.00	1 364.00	7.15
4	94	95	1	1 461.26	1 461.26	1 461.26	1 461.26	7.66
4	97	98	1	1 511.80	1 511.80	1 511.80	1 511.80	7.93
4	99	100	1	2 166.00	2 166.00	2 166.00	2 166.00	11.36
4	0	100	38	501.77	42.28	2 166.00	19 067.42	100
17	0	10	4	60.37	55.9	62.88	241.48	0.88
17	10	20	4	81.49	65.44	91	325.94	1.19
17	20	30	4	126.5	115	146	506	1.85
17	30	40	4	197.42	190	213.68	789.68	2.89
17	40	50	4	278.97	221.87	314	1 115.87	4.09
17	50	60	4	359.82	320	385	1 439.28	5.27
17	60	70	4	533.25	398	591	2 133.00	7.81
17	70	80	4	779.5	696.8	874	3 118.00	11.42
17	80	90	4	1 540.90	1 155.60	1 800.00	6 163.60	22.57
17	90	100	5	2 296.26	1 999.10	3 035.20	11 481.30	42.03
17	91	92	1	1 999.10	1 999.10	1 999.10	1 999.10	7.32
17	93	94	1	2 061.50	2 061.50	2 061.50	2 061.50	7.55
17	95	96	1	2 090.50	2 090.50	2 090.50	2 090.50	7.65
17	97	98	1	2 295.00	2 295.00	2 295.00	2 295.00	8.4
17	99	100	1	3 035.20	3 035.20	3 035.20	3 035.20	11.11
17	0	100	41	666.2	55.9	3 035.20	27 314.15	100

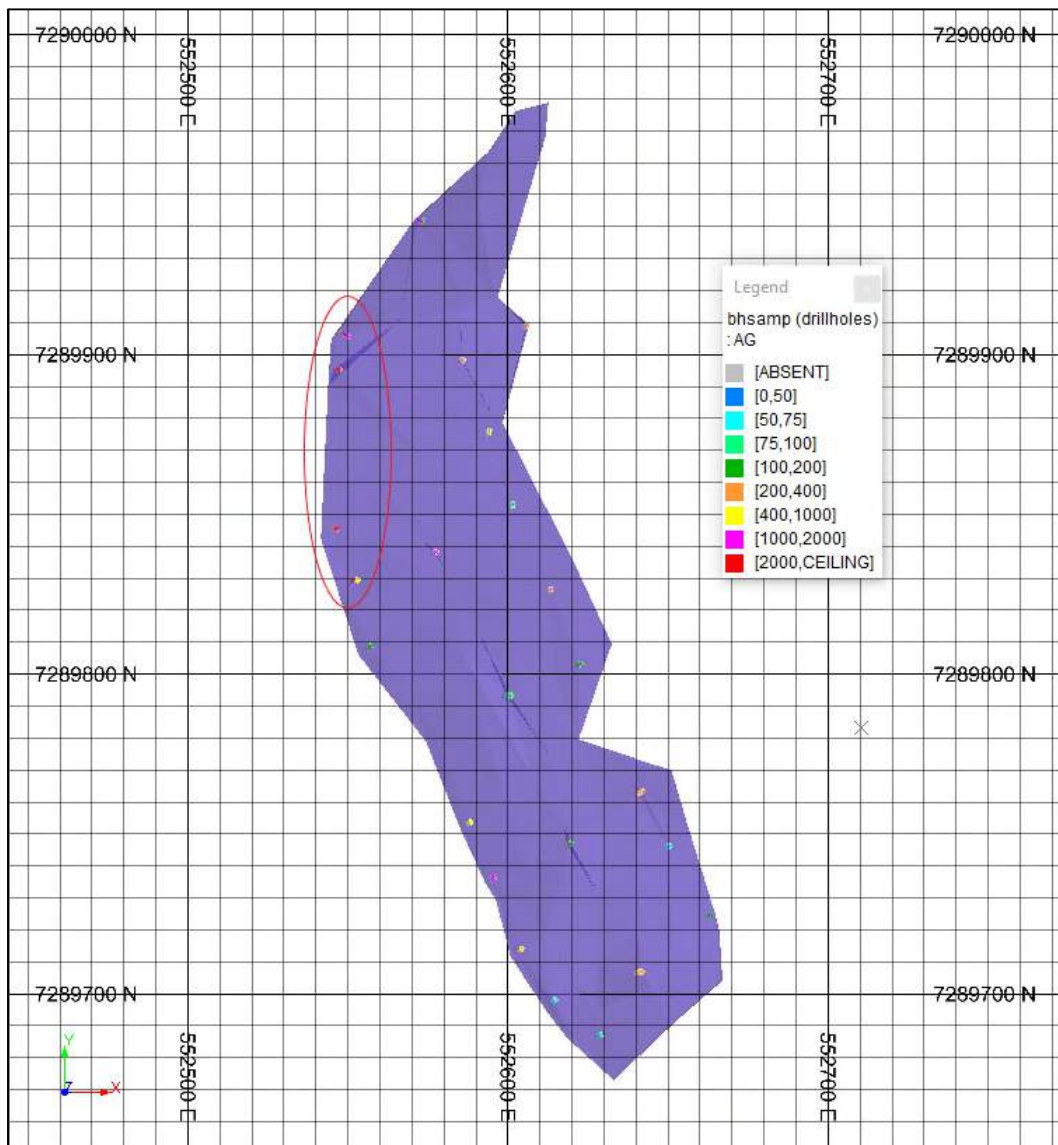


Figure 14.26: Trench Location with High Grade of Silver, Zone 17.

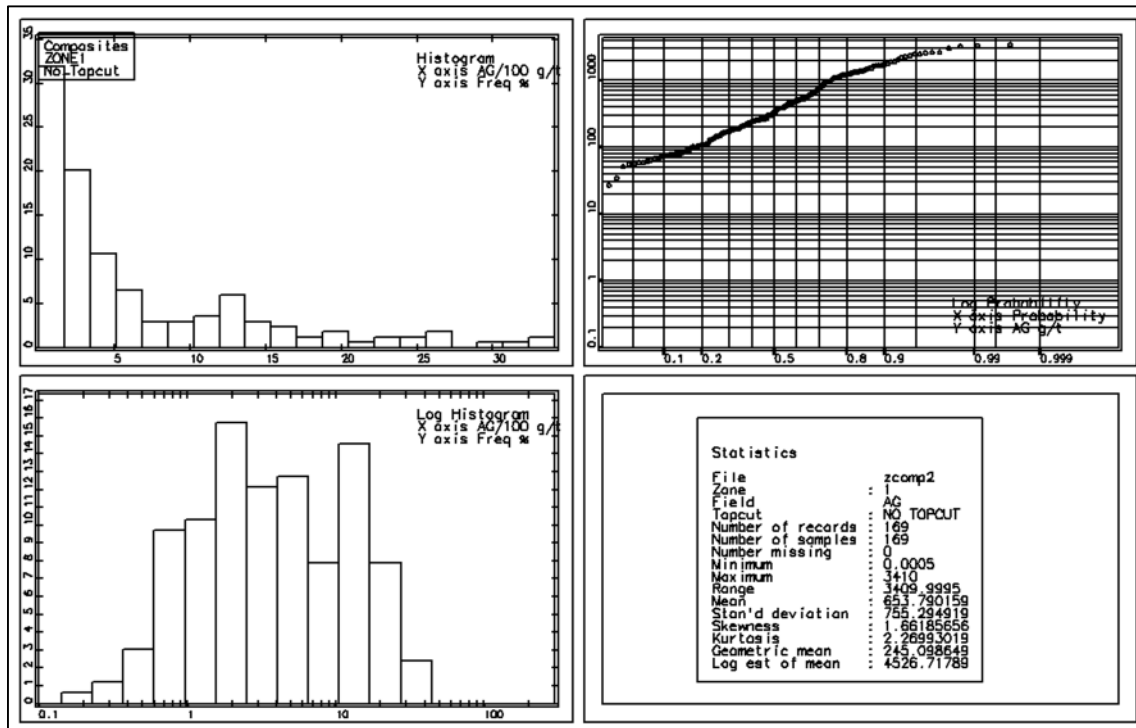


Figure 14.27: Statistical Plots for Silver, Zone 1

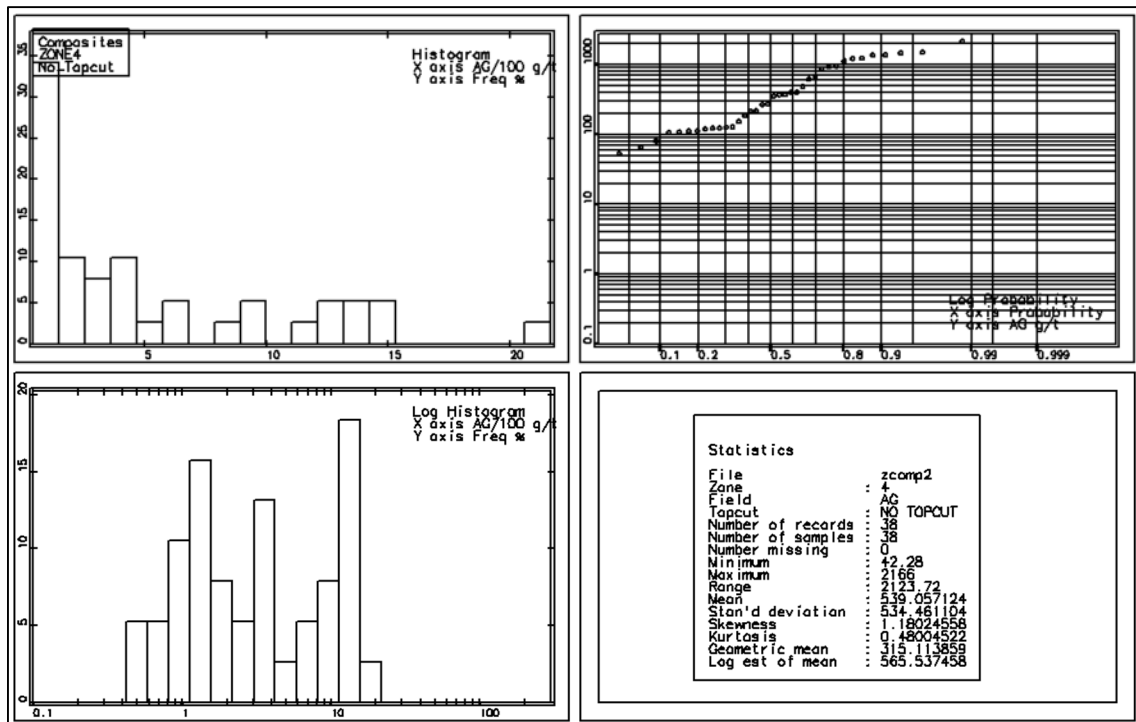


Figure 14.28: Statistical Plots for Silver, Zone 4

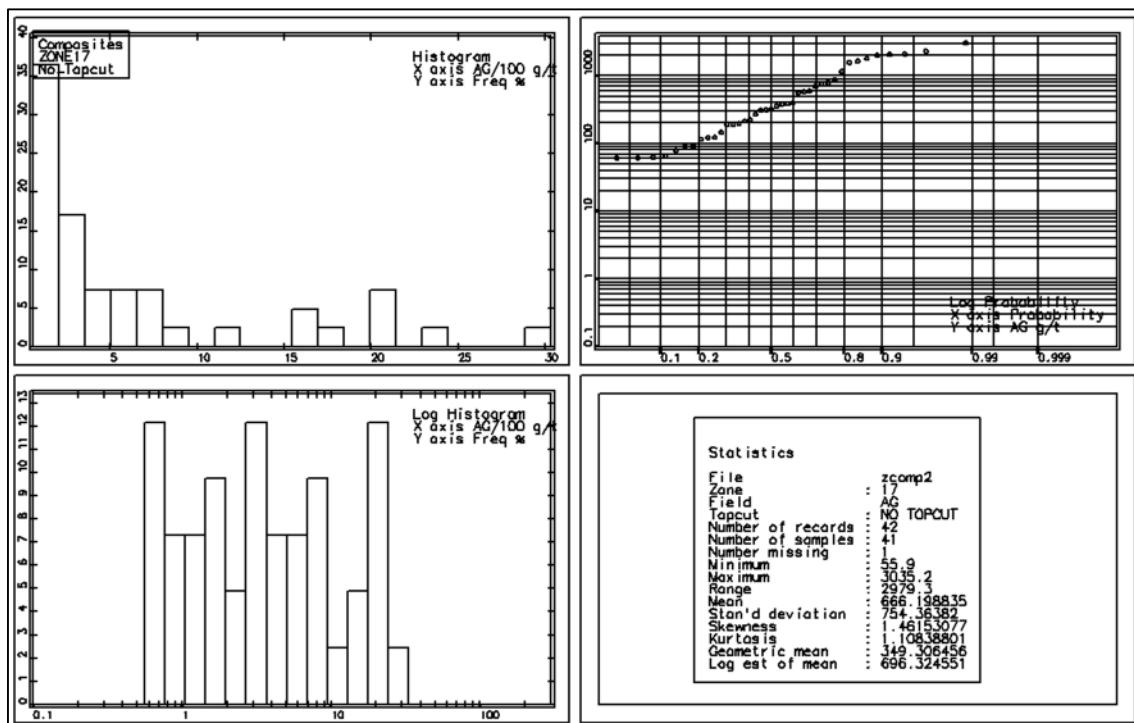


Figure 14.29: Statistical Plots for Silver, Zone 17

#### 14.2.5.4 Variogram Modelling

The top-cut composites were used for modelling of experimental semi-variograms. Robust variogram models were produced for silver for Zone 1 which is the largest zone at Mangazeisky North. Due to a low number of composites, and/or their irregular spacing, it was impossible to model robust variograms for the remainder of the zones and metals. An example of the along strike, down-dip and across the strike modelled variogram for silver for Zone 1 is shown in Figure 14.30, Figure 14.31 and Figure 14.32. The parameters of the modelled variograms are presented in Table 14.32.

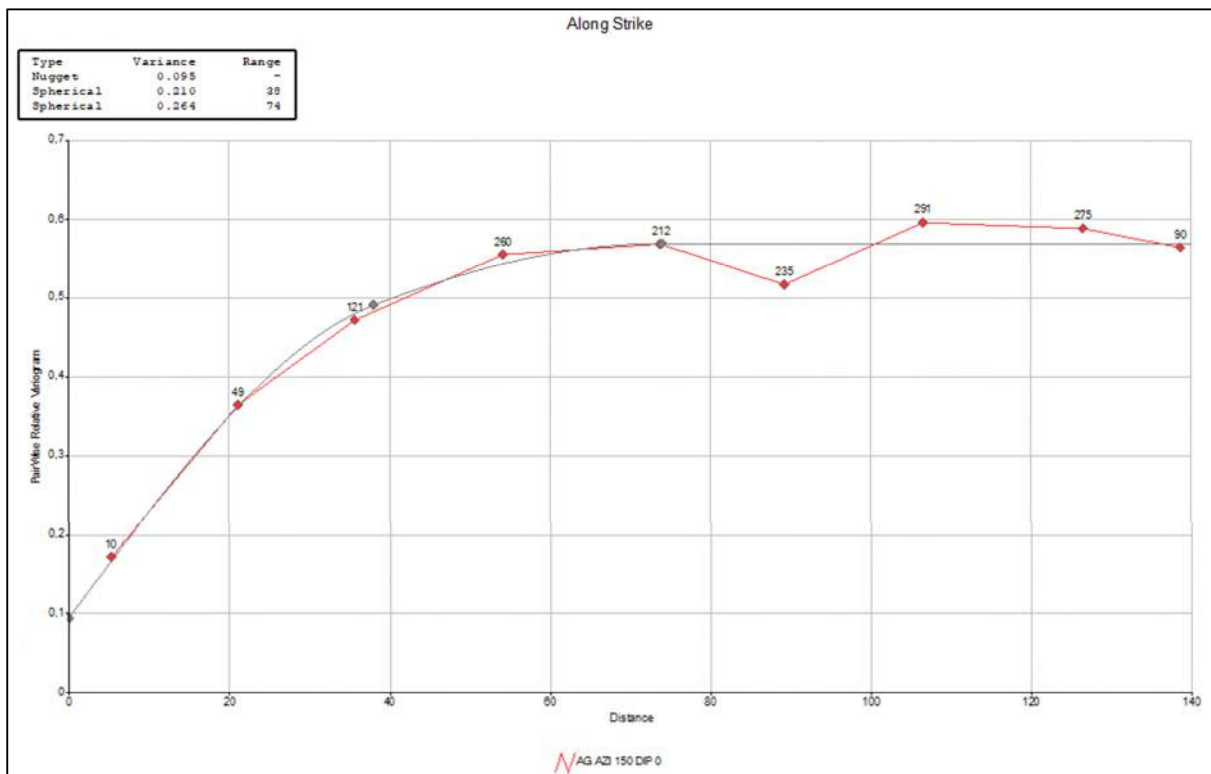


Figure 14.30: Ag Modelled Variogram, Zone 1, Along the Strike

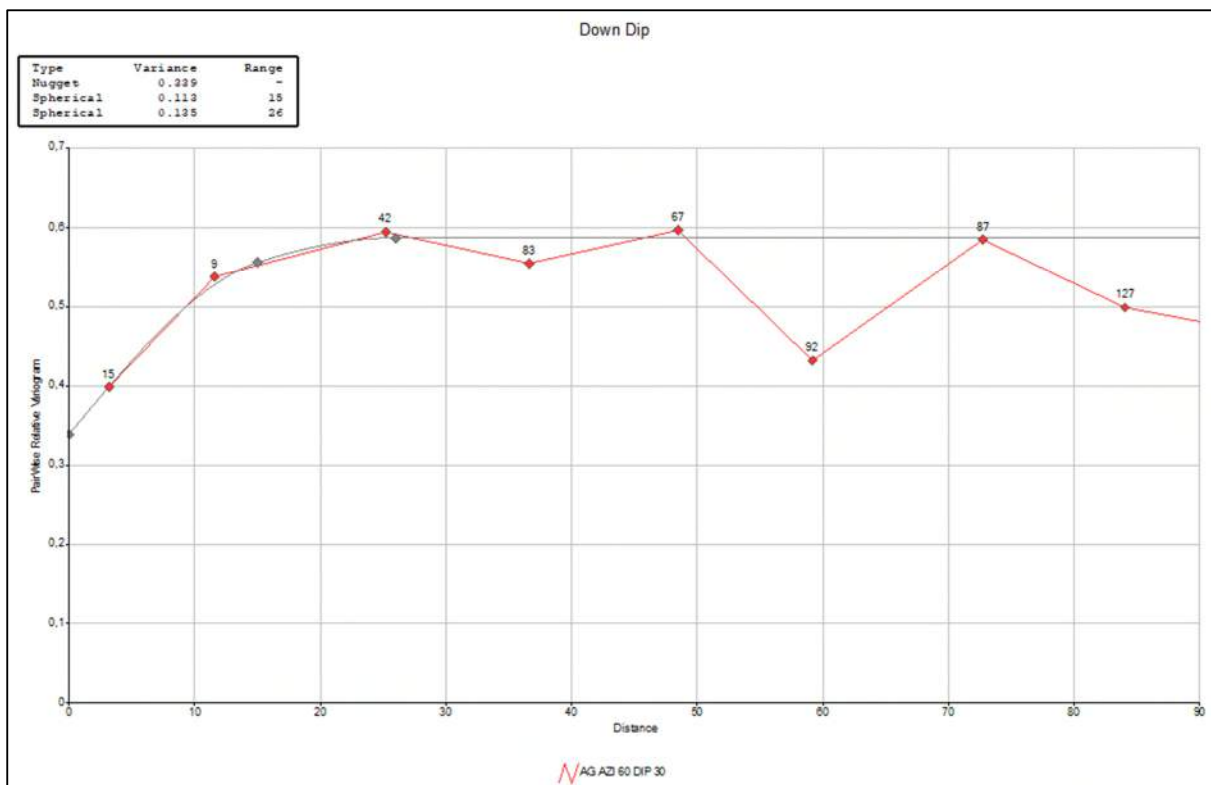


Figure 14.31: Ag Modelled Variogram, Zone 1, Down-Dip

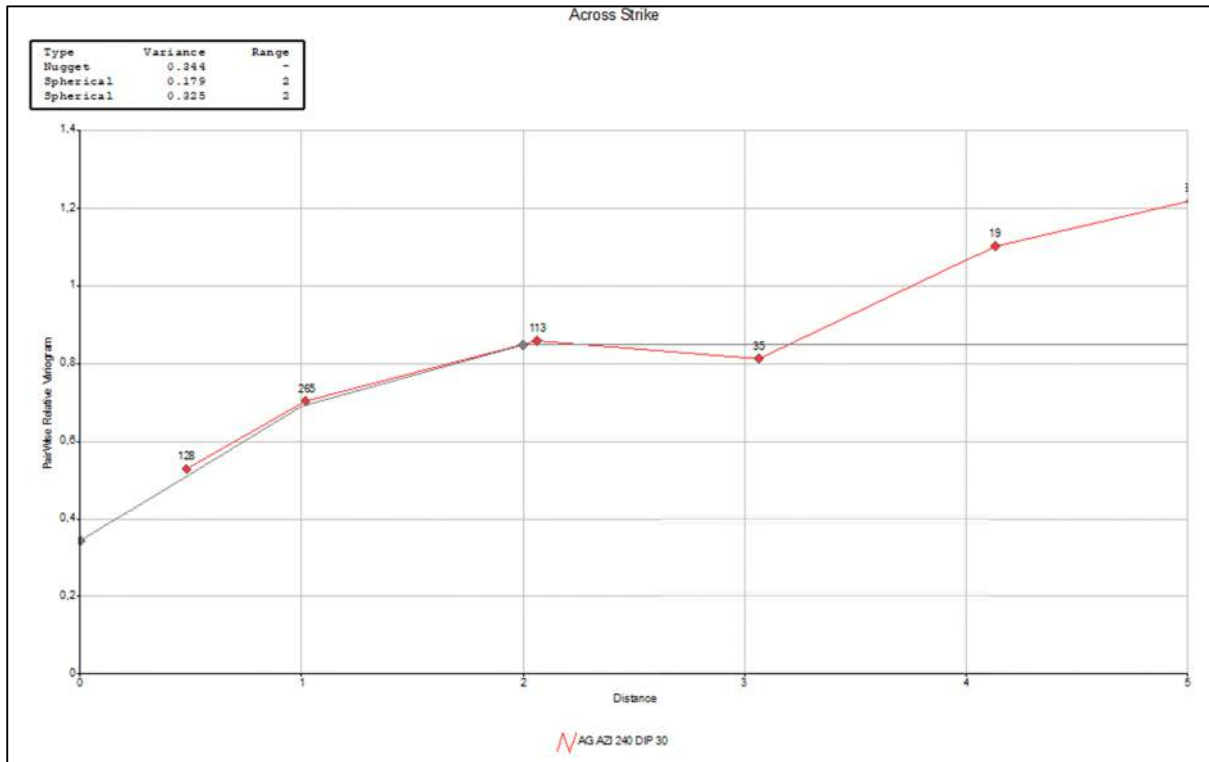


Figure 14.32: Ag Modelled Variogram, Zone 1, Across the Strike

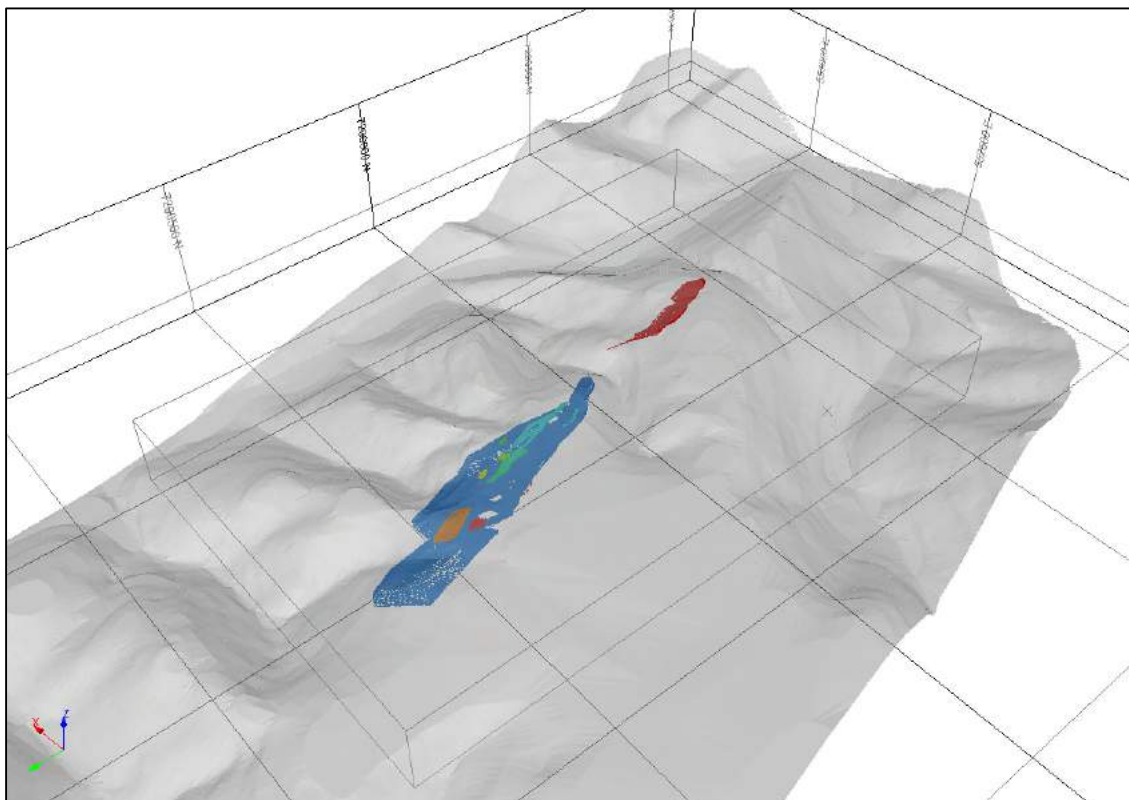
Table 14.32: Parameters of Modelled Variograms for Silver, Zone 1			
Parameters	Along the Strike	Down-Dip	Across the Strike
Zone	1	1	1
File	z1wcomp1	z1wcomp1	z1tcomp1
Lag	18	12	1
Nlag	8	6	6
HorAng	60	50	40
VerAng	60	50	40
CylRad	100	80	50
Ang1	150	60	240
Ax1	3	3	3
Ang2		30	30
Ax2		1	1
VarType	RV	RV	RV
MoRefNo	1	4	3
Nugget	0.095	0.339	0.344
R1	38.1	15.3	1.7
C1	0.21	0.113	0.179
S1	0.305	0.452	0.524
R2	74	26.1	2.1
C2	0.264	0.135	0.325
S2	0.569	0.587	0.849

## 14.2.6 Block Modelling

### 14.2.6.1 Block Model Prototype

The block model was constructed using Datamine with a parent cell size of 10m x 10m x 10m (along strike, across strike and vertical), sub-celling was allowed down to 1.0m x 1.0m x 2.0m. The block model was created within the individual zone wireframes. The block model also reflects the DTM surface, also outlines the blocks corresponding to unconsolidated sediments overlaying the bedrock. No rotation has been applied to the model. A summary of the parameters used in the model prototype is shown in Table 14.33. The block model relative to the surface with outlined oxide and primary mineralization is shown in Figure 14.33.

Parameters		Direction	Size
Model Origin		X	552,065
		Y	7,289,495
		Z	1,062
Model Parameters	Parent Block Size	X	10
		Y	10
		Z	10
	Number of Blocks	X	86
		Y	137
		Z	16

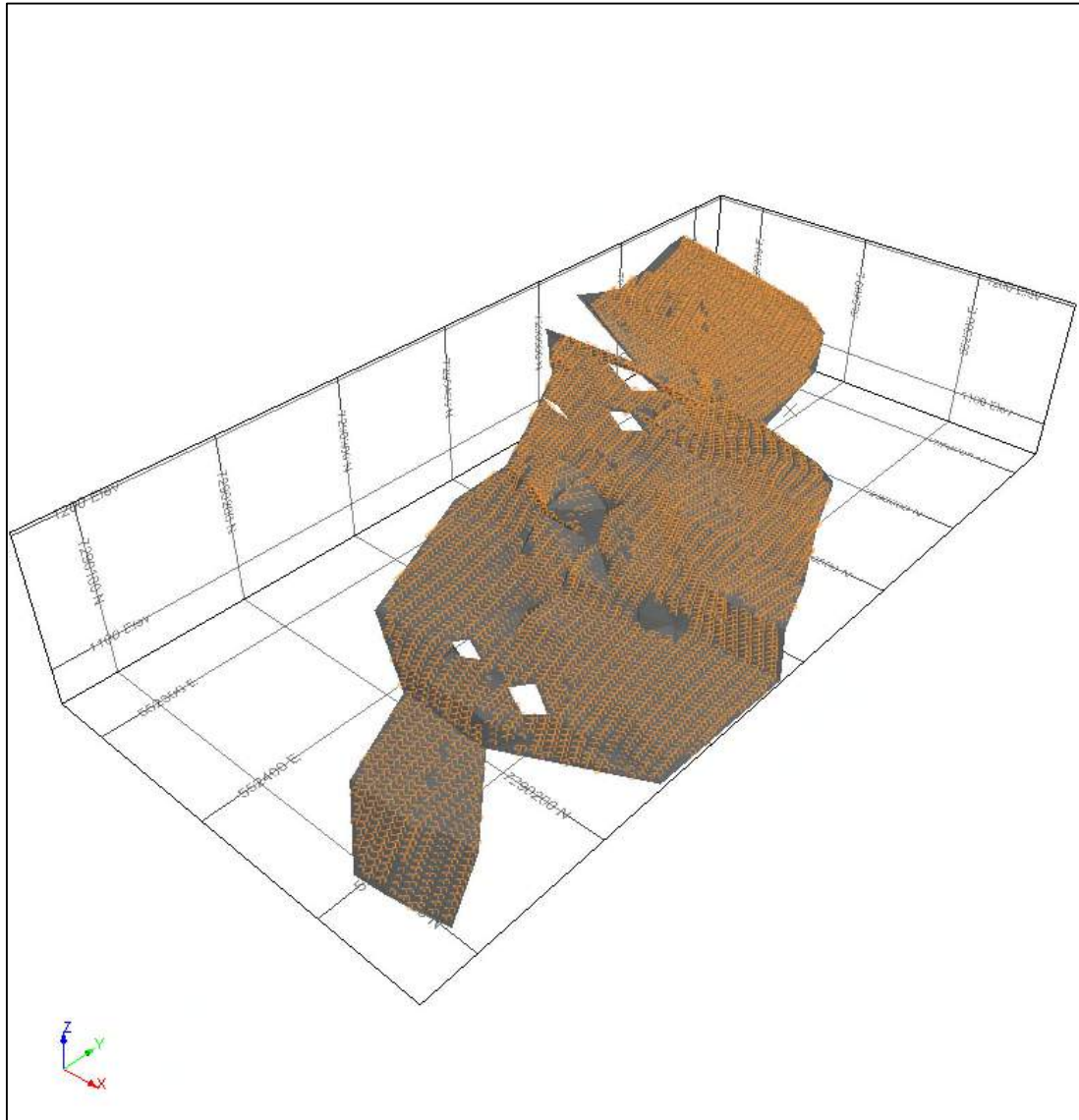


**Figure 14.33: Block Model of Mangazeisky North Mineralization Relative to Surface**

#### 14.2.6.2 *Dynamic Anisotropy*

Parameters of dynamic anisotropy showing the true dip angle and azimuth were interpolated into the blocks of each individual zone of mineralization. In order to produce the points with true dip angle and azimuth WAI modelled wireframes corresponding with the axial surfaces of mineralized zones. Points with true dip angles and azimuth corresponded with the centers of triangles of these wireframes.

An example of location of points of dynamic anisotropy for Zone 1 is shown in Figure 14.34.



**Figure 14.34: Wireframe Model of Zone 1 with Points Used to Determine Dynamic Anisotropy**



#### 14.2.6.3 Density

CJSC Prognoz provided the density data on rocks and ores determined from the drill core of 2014. A total of 68 samples from 33 drillholes was taken. The summary data on the density determination for individual zones of mineralization and host rocks are given in Table 14.34.

<b>Zone</b>	<b>Number of samples</b>	<b>Average, t/m<sup>3</sup></b>
1	35	3.54
2	3	2.66
5	2	2.61
6	1	2.73
10	1	3.36
14	4	3.19
15	1	2.69
16	1	2.64
<b>Total for the mineralized material</b>	<b>48</b>	<b>2.93</b>
<b>Host rocks</b>	<b>20</b>	<b>2.70</b>

The largest number of samples used to determine the density value was in Zone 1, the average density was 3.54t/m<sup>3</sup>. Given that there is not enough data to identify the zone of oxidation, all mineralization in Mangazeisky North was assigned to primary mineralisation. The final density values for the estimation of mineral resources were accepted by analogy with the Vertikalny deposit and amounted to:

- All mineralization (without division into primary and oxide ores) – 3.56t/m<sup>3</sup>
- Host rocks – 2.75t/m<sup>3</sup>

#### 14.2.6.4 Grade Interpolation

WAI has used Ordinary Kriging (OK) as the principal interpolation method and Inverse Power Distance Cubed (IPD3) as the secondary method for silver, lead, and zinc. Zonal control and dynamic anisotropy were used for grade interpolation. Eight estimation passes were run with each one using a consecutively larger ellipsoid to ensure that all blocks were estimated.

The grade interpolation plan is presented in Table 14.35

Run 1 (strike x downdip x cross-strike)	1/3 x 1/3 x 1/3 radii
Run 2 (strike x downdip x cross-strike)	1 x 1 x 1 radii
Run 3 (strike x downdip x cross-strike)	2 x 2 x 2 radii
Run 4 (strike x downdip x cross-strike)	4 x 4 x 4 radii
Run 5 (strike x downdip x cross-strike)	6 x 6 x 6 radii
Run 6 (strike x downdip x cross-strike)	8 x 8 x 8 radii
Run 7 (strike x downdip x cross-strike)	16 x 16 x 16 radii
Run 8 (strike x downdip x cross-strike)	30 x 30 x 30 radii
Min comp no (run 1/2/3/4/5/6/7/8/9)	2/2/2/2/2/1/1
Max comp no (run 1/2/3/4/5/6/7/8/9)	8/8/8/8/8/15/15
Min Octan no (run 1/2/3/4/5/6)	2/2/2/2/1/1/1
Max comp no from 1 hole	4/4/4/4/4/4/4
Note –	
1) Dynamic Anisotropy used for search ellipsoid orientation	

The size of search ellipsoid for silver in Zone 1 was used for all metals and zones as shown in Table 14.36.

Metal	Zone	Radii, m		
		Along the Strike	Down-Dip	Across the Strike
All	All	74	26.1	2.1

#### 14.2.6.5 Model Validation

Following grade estimation, a statistical and visual assessment of the block model was undertaken:

1. To assess successful application of the estimation passes;
2. To ensure that as far as the data allowed, all blocks within mineralisation domains were estimated; and
3. To ensure the model estimates performed as expected.

The model validation methods carried out included global statistical grade validation, a visual assessment of grades, and swath plot (model grade profile) analysis.

#### *i) Statistical Comparison*

Statistical analysis of the block model was carried out to compare the interpolation results against composite and initial sample data. This analysis provides a check on the reproducibility of the mean grade of the composite and initial sample data against the model over individual mineralized zones. Typically, the mean grade of the block model should not be significantly greater/lower than that of the composites from which it has been derived.

WAI has carried out a comparison between interpolated grades in the block model (BM), grade in the initial samples, and 1.0m composites used for interpolation. Global comparison was only undertaken for silver grades for each individual zone (Table 14.37).

Zone	Volume (,000m <sup>3</sup> )	Tonnes (Kt)	Qty of composites	Average Ag Grade, g/t		
				Sample	Composite	Block Model
1	106.38	378.71	171	614.21	609.40	636.54
2	1.27	4.53	15	657.91	633.87	378.38
3	0.75	2.67	4	232.93	232.93	218.58
4	6.42	22.87	38	471.20	476.75	326.26
5	2.51	8.92	8	321.62	328.82	284.16
6	0.25	0.89	2	1,799.56	1,742.29	1,961.68
7	0.32	1.15	2	265.65	265.65	367.34
8	0.48	1.71	4	235.65	235.65	234.89
9	0.28	0.98	3	109.18	110.42	100.99
10	0.60	2.12	2	194.72	194.72	168.74
11	0.28	1.01	2	1,606.25	1,606.25	1,604.67
12	0.03	0.10	1	237.60	237.60	237.60
13	0.03	0.10	2	1,228.95	1,228.95	1,101.26
14	3.70	13.17	13	428.98	428.98	502.99
15	0.58	2.08	2	736.74	736.25	734.45
16	0.26	0.92	1	1,968.00	1,968.00	1,968.00
17	9.89	35.20	41	728.55	722.77	536.94

**ii) Visual Comparison**

A visual comparison of composite grades and block grade was completed in cross section and in plan. An example of visual comparison of silver grade in the block model and composite within drillholes is presented in Figure 14.35. Visually the model was generally considered to reflect the composite grades.

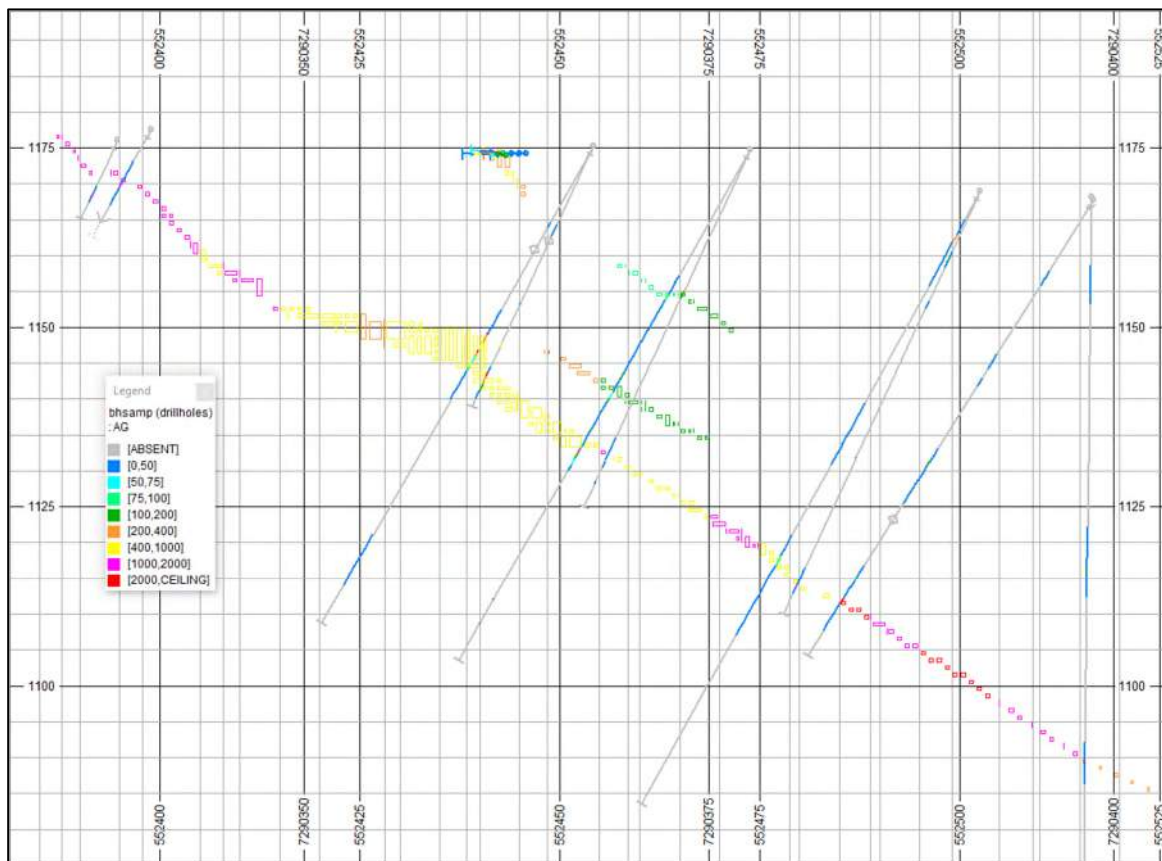


Figure 14.35: Block Model Grades vs Original Samples

**iii) Local Comparison (SWATH Plot)**

Swath plots were generated to compare the average block model grade and grade in the composite data (example is given in Figure 14.36). A series of 100m slices from south to north and horizons in 50m bottom-upwards were used to assess the average grade for the block model and for composite data. A generally close relationship was observed between composite and block grade across the model. Some deviations between the composite and estimated block grade occur at the edges of the deposit where reduced tonnages accentuate the differences in grade. Differences in grade also become more apparent in lower grade areas. These lower grade areas are typically where the density of drilling decreases, and a few composites can have a disproportionate effect on the estimated grades.

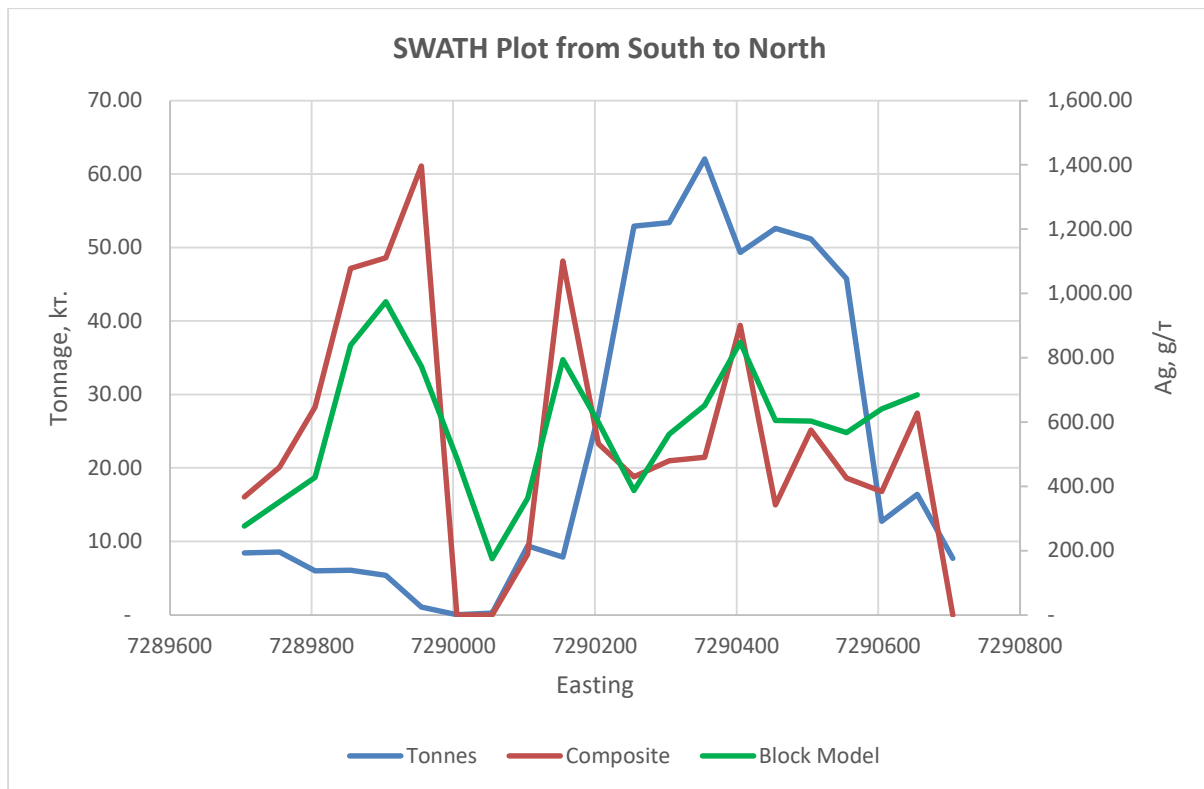


Figure 14.36: SWATH Plot for Ag, looking from South to North

iv) **Validation Summary**

Globally no indications of significant over or under estimation are apparent in the model nor were any obvious interpolation issues identified. From the perspective of conformance of the average model grade to the input data, WAI considers the model to be a satisfactory representation of the sample data used and an indication that the grade interpolation has performed as expected. In terms of conformance to the drill hole composite data, WAI considers the OK interpolation method to most closely represent the drillhole data. The Mineral Resource Estimate is therefore based upon the OK grade estimation for all zones.

As a general comment, the validations only determine whether the grade interpolation has performed as expected. Acceptable validation results do not necessarily mean the model is correct or derived from the right estimation approach. It only means the model is a reasonable representation of the data used and the estimation method applied.

14.2.6.6 *Mineral Resource Classification*

The Mangazeisky North mineral resources are classified in accordance with the Australasian Code for Reporting of Exploration Results, Mineral Resources and Ore Reserves [the JORC Code (2012)].

### ***i) Considerations for Mangazeisky Resource Classification***

To classify the Mangazeisky North deposit, WAI has taken into account the following indicators:

- Geological Continuity and Complexity;
- QA/QC Results - Quality of Data;
- Spatial Grade Continuity - Results of Geostatistical Analysis; and
- Quality of Block Model.

Since it is impossible to delineate and determine the geometry of oxide and primary mineralization at Mangazeisky North, WAI believes that the silver, lead, and zinc resources can only be classified as Inferred.

#### ***Geological Continuity and Complexity:***

With the current drill hole/trench spacing, geological continuity between exploration profiles both along strike and down dip is seen. The current drill hole spacing allows for interpretation of continuous zones of mineralisation based on the cut-off grades of 50g/t Ag. At the same time, the submitted data is insufficient to delineate mineralization of different types – oxide and primary.

#### ***Data Quality:***

QA/QC results of exploration data show acceptable results when measuring accuracy, precision and contamination. This data can be used for estimation of mineral resources.

#### ***Spatial Grade Continuity:***

An assessment of spatial grade continuity is important when assigning classification to a Mineral Resource. The confidence that can be placed in the variogram parameters is a major consideration when determining classification. The data used in geostatistical analysis resulted in reasonably robust along strike and down dip variogram structures for silver. However, no variograms could have been created for lead and zinc.

#### ***Block Model Veracity:***

Validation of the block model has shown the estimated grades to be a good reflection of the input composite grades. Visual and statistical checks reveal no evidence of major under or over estimation.

### ***ii) Final Classification***

WAI considers that Mangazeisky North has been sufficiently explored to assign Inferred Mineral Resources as defined by JORC Code (2012).

#### 14.2.6.7 Reasonable Prospects of Economic Extraction

Parameters for constraining of mineral resources at Morth Mangazeisky were similar to that for the open pit optimization at Vertikalny, except for the following:

- Oxide mineralization was not delineated due to the lack of data;
- The accepted overall slope angle was 45° due to a limited geotechnical dataset.

The mineral resources for open pit mining constrained to the open pit shell are illustrated in Figure 14.37.

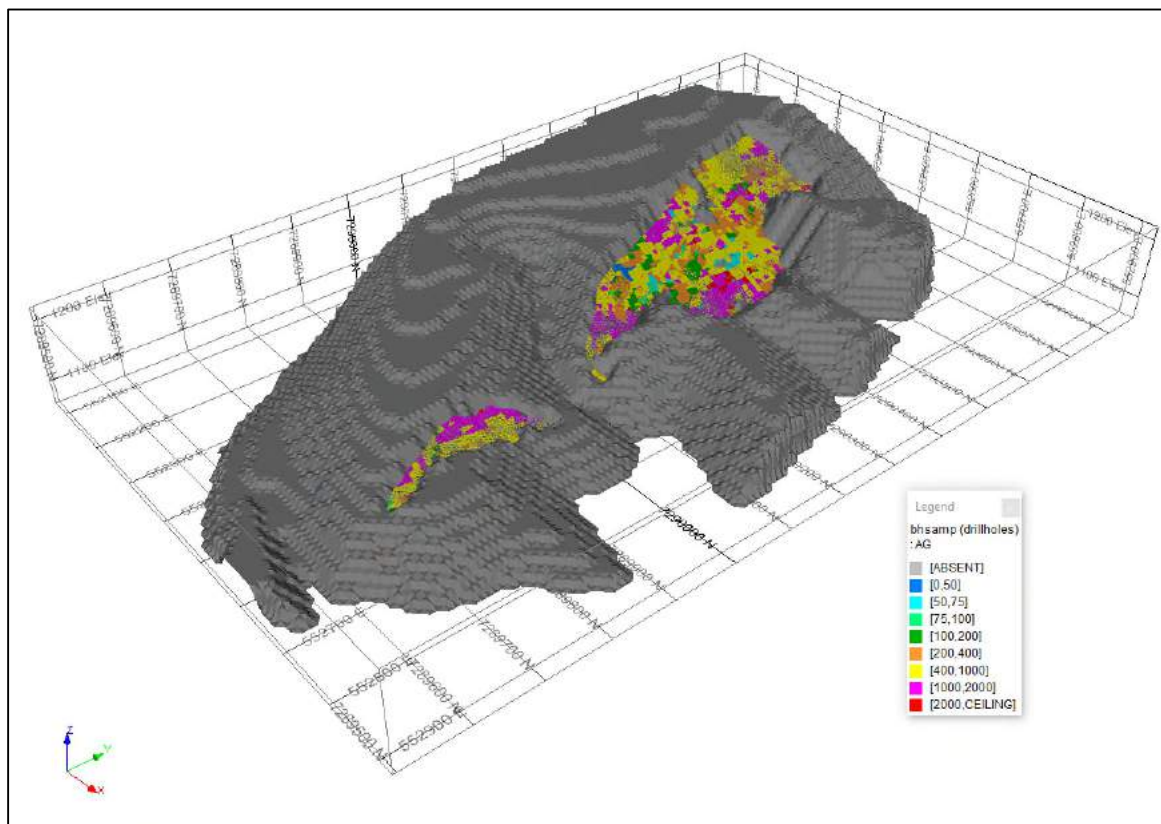


Figure 14.37: Mineral Resources for Open Pit Mining

#### 14.2.7 Mineral Resource Statement for Mangazeisky North

The Mangazeisky North mineral resources have been estimated in accordance with the guidelines of the JORC Code (2012) as seen in Table 14.38.

WAI is not aware, at the time of preparing this report, of any modifying factors such as environmental, permitting, legal, title, taxation, socioeconomic, marketing, and political or other relevant issues that may materially affect the Mineral Resource estimate herein; nor that the Mineral Resource estimate may be affected by mining, metallurgical, infrastructure or other relevant factors.

**Table 14.38: Mineral Resource Estimate. Mangazeisky North Project, Russia. 31<sup>st</sup> of May 2019  
 (In Accordance with the Guidelines of the JORC Code (2012)) Potential Open Pit Resources**

Ag Cut-off, g/t	Category	Tonnes, Kt	Ag, g/t	Pb, %	Zn, %	Ag, kg	Pb, t	Zn, t
200	Inferred	331.41	750.15	9.71	0.98	248,612	32,185	3,261

**Notes:**

1. Mineral Resources are reported in accordance with the guidelines of the JORC Code (2012).
2. Mineral Resources are not Ore Reserves until they have demonstrated economic viability based on a feasibility study or pre-feasibility study.
3. Mineral resources include all potential mineable tonnage.
4. Mineral Resources are estimated as of 31 May 2019.
5. Mineral Resources were constrained by conceptual optimum pit contours using NSR and in accordance with the parameters presented in Table 14.20.
6. All values in the tables have been rounded with relative accuracy of estimate. Numbers may not compute due to rounding.
7. Mineral Resources were constrained by an optimum pit shell based on the corresponding economic and mining parameters provided by the Client and/or accepted by WAI
8. This mineral resource estimate is not limited to any factors in terms of environmental, permitting, legal, title, taxation, socio-economic, market and other relevant factors.
9. The metal resources include all the in-situ metal disregard the metallurgical recovery factor.

**14.2.8 WAI MRE vs. Tetra Tech MRE**

Tetra Tech (TT) estimated mineral resources of Mangazeisky North in 2017. Mineralized wireframe models were developed and samples within the wireframes were taken followed by compositing of 0.4m. The undertaken statistical analysis did not identify silver outliers for top-cutting. The variogram models were created in three directions with the following search radii:

- Along the strike – 95m;
- Down-dip – 45m;
- Across the strike – 15m.

The density values were interpolated to the block model using the Inverse Power Distance Squared; the blocks without the estimated density values were assigned with 3.18 t/m<sup>3</sup>. Ordinary kriging was used to interpolate grades to the block model; several estimation passes were run with each one using a consecutively larger ellipsoid.

The following parameters were used to determine the potential for economic extraction of mineralization:

- Silver price – 17 US\$/oz;
- Losses – 5%;
- Dilution – 30%;
- Operational costs:
  - For mining – 2.53 US\$/t ore
  - For processing – 52 US\$/t ore;
  - G&A – 40.60 US\$/t ore;
- Royalty – 6.5%;
- Overall recovery – 88%.



Based on these parameters TT concluded that the 150g/t Ag cut-off grade shall be applied to the mineralization to estimate mineral resources (Table 14.39).

<b>Table 14.39: Mineral Resource Estimation, Tetra Tech, 2017</b>			
<b>Category</b>	<b>Tonnage, kt</b>	<b>Ag, g/t</b>	<b>Ag, kg</b>
Indicated	334	770	257,180
Inferred	127	560	71,120
<b>Total</b>	<b>461</b>	<b>712</b>	<b>328,300</b>

Location of the TT and WAI mineralized wireframes is shown in Figure 14.38. The TT mineral resources were not constrained to the optimum RF1 pit shell. It should be noted that the TT model was extrapolated for a significant distance downdip from the workings at the deposit owing to wider drill spacing and assumption of greater continuity of mineralisation. The additional drill results incorporated in the WAI MRE have enabled greater definition of the resource model albeit more conservative in response to greater discontinuity. In this regard, it is not conducive to undertake direct comparison of the TT and WAI mineral resources.

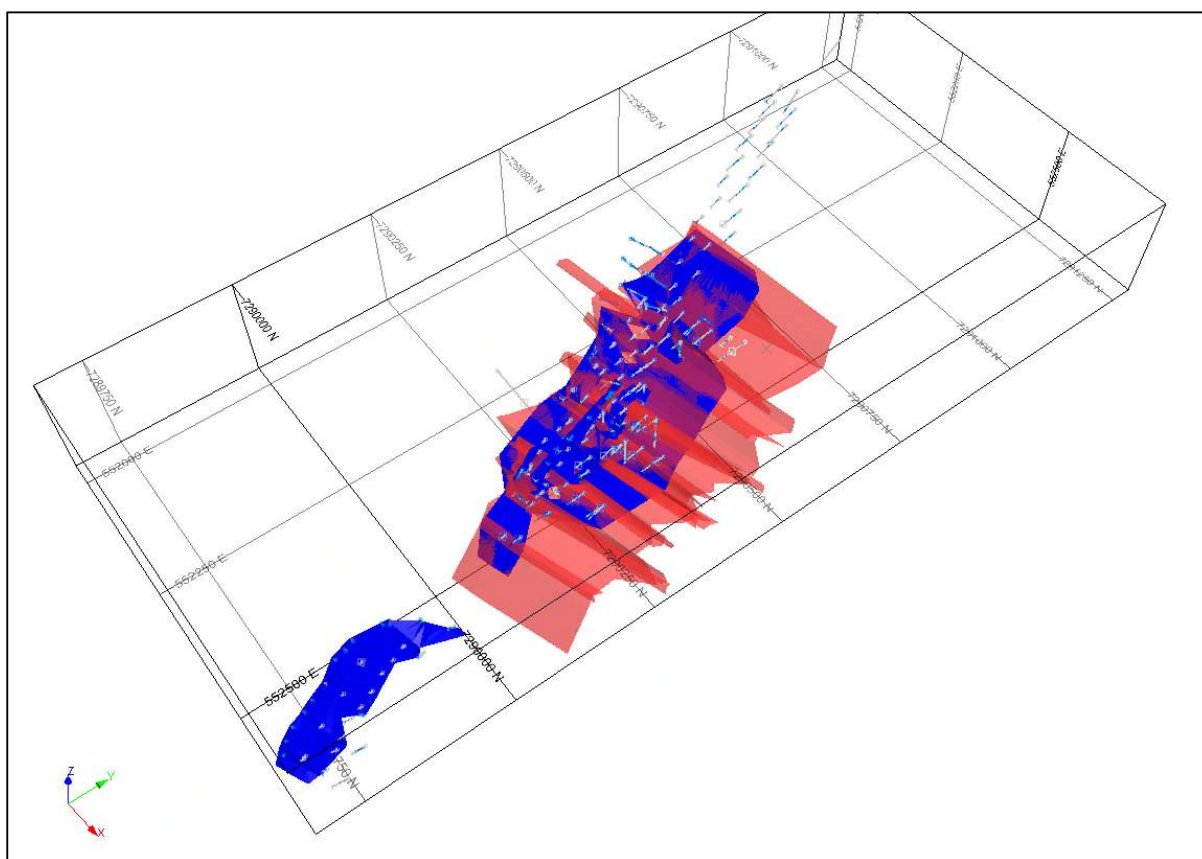


Figure 14.38: Wireframe Models of TT (red) and WAI (blue) with workings at Mangazeisky North

## **15 MINERAL RESERVE ESTIMATE**

Estimation of mineral reserves has not formed part of this study and are not reported here.

It should be noted that 'minable tonnage estimates' are not Ore Reserves and are not demonstrative of technical and economic viability. The study was carried out to assess the potential of the Mangazeisky Silver Project as whole and identify any strategic bottlenecks.

The use of 'minable tonnage estimate' or 'minable tonnes' and its relationship to Mineral Resource Estimates is discussed further in Section 16.5.

## **16 MINING METHODS**

### **16.1 Mining Methods**

WAI has carried out a scoping level open pit mining study to define a mineable tonnage estimate for the Vertikalny and Mangazeisky North deposits. The Vertikalny deposit is currently being extracted by open pit mining techniques, whereas the Mangazeisky north deposit is greenfield and has yet to be mined.

WAI has also carried out a mining study to define an underground mineable tonnage estimate for the Vertikalny deposit. The study has considered the volume of mineralised material below the generated Vertikalny pit designs. The study is based on applying a stope optimiser to the mineable tonnage estimate and assessment of supporting development/infrastructure and constitutes only a high-level conceptual design given that ‘minable tonnage estimates’ are not Ore Reserves and are not demonstrative of technical and economic viability.

### **16.2 Hydrology and Hydrogeology**

#### **16.2.1 Introduction**

This assessment considers hydrogeological modifying factors relating to mining of the open pits at the Vertikalny deposit and subsequent open pit mining of the Mangazeisky North deposit. The review is based on information provided by the client. Hydrogeological modifiers associated with underground mining (Vertikalny) are also considered at a development parameter level only.

The assessment is based on a review of the completed works, available designs and WAI’s own mine pre-design opinion. Project technical and economic factors are considered, environmental and social (E&S) assessment has been excluded from the scope, however any significant hydrogeological factors affecting E&S are noted for consideration in the next project phase. Hydrogeology may affect pit shell design, feasibility, mining parameters and production scheduling if significant groundwater control is required. The performance of the mine has varied from the feasibility benchmarks primarily because of geological (resource) in-situ variability, ore processing costs, mining costs – however this is predominantly due to the variation in ROM production rather than the intrinsic cost of mining, and administrative and infrastructure costs. The role that mine-water management has played (if any) on affecting mining costs is examined below.

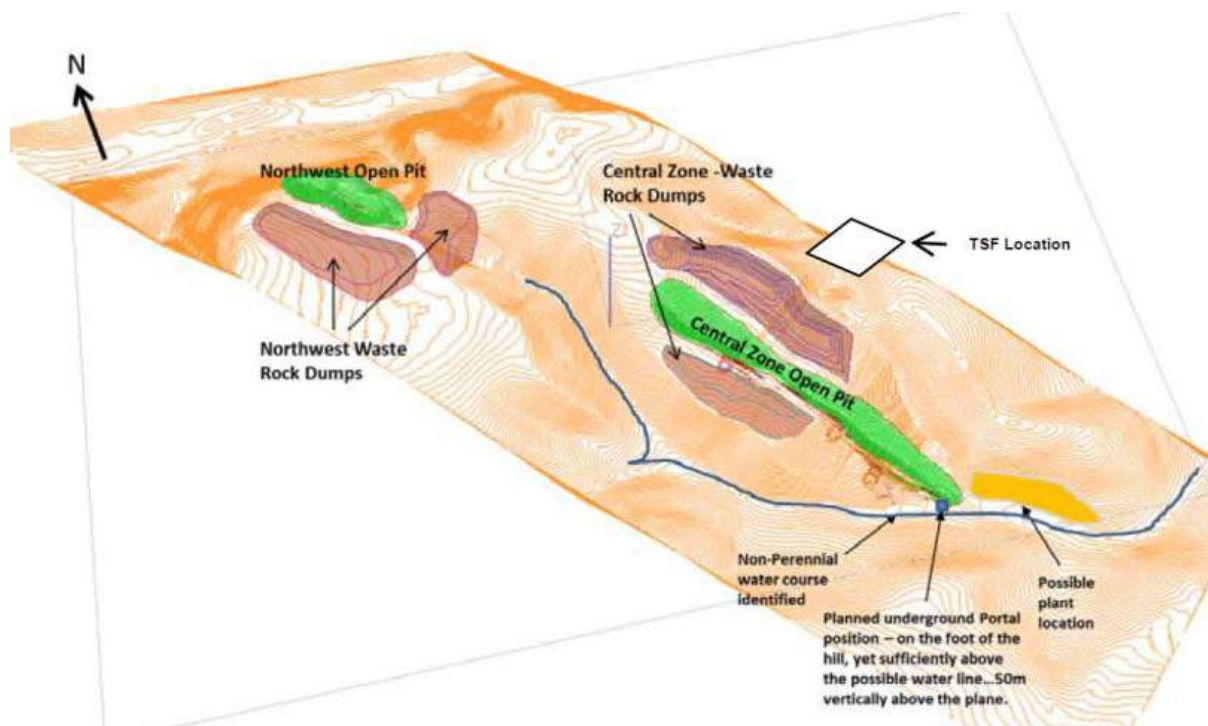
#### **16.2.2 Hydrogeology**

##### **16.2.2.1 General**

The Mangazeisky silver deposit, comprising multiple targets along a N-S striking orebody is within the Endybal River basin, a tributary of the Arkachan River. Six named rivers and smaller streams are noted within the Licence area. These streams are classified as sixth and lower order watercourses (with overall drainage to the Yana River): Feodor-Yureghe River, Sirilendzhe River, Mangazeyka River,

Porfirovy Creek (adjacent to the southern termination of the Vertikalny pit and approximately 50m below the underground mine portal), Borisovsky Creek and Nameless Creek. The rivers are typically upland type characterised by low salinity, soft, weakly alkaline quality not exceeding 30m cross-sectional width at maximum spate condition. The creeks are typically ephemeral in the order of less than 2m width. Natural geochemical parameters in the surface water result in exceedances of regulatory Maximum Permissible Concentrations (MPC) for lead, zinc, aluminium, nickel and cadmium in a number of samples reflective of the mineralisation of the region.

The mining operations target the Vertikalny vein's Central and Northwest Zones of mineralisation, situated in the Mangazeisky licence area. The Central Zone extends for some 1,600m along strike, Northwest Zone extends approximately 900m along strike. The process plant site is located in the Porfirovy stream valley. The project water supply is direct run-of-river abstraction principally from the Arkachan river, with additional summer flow supplements withdrawn from local creeks (Endybal and Mangazeisky) as necessary (ERM, 2014).



**Figure 16.1: Approximate Mine Layout Sand Topographic Relationship (ERM, 2014).**

The climate is extreme continental arctic with average snow cover days of 240 per year and low precipitation average – 320mm of which a third is as snow. Spring thaw occurs in early May and snow begins to settle in September with permafrost prevalent across the terrain. The area has very low wind activity and precipitation is anticipated to be negligible given the prevailing summer temperatures do not generally exceed 13°C (ERM, 2014).

#### 16.2.2.2 *Hydrogeological Description*

The project is at the edge of the Siberian platform in the interfluvium of the Nuektame and Arkachan rivers. The site is within the West-Verkhoyansk hydrogeological massif. Fractured aquifers within sandstones, siltstones, conglomerates and shales (Carboniferous - Permian age) are understood to be modified by faulting, structural blocking and compartments and metamorphic texture and facies controls. Overprinting the lithology and aquifer characteristics is a layered permafrost system comprising an upper active zone where annually porewater freezes and thaws, and an underlying permafrost zone in which porewater is permanently frozen. Below the permafrost at depth, groundwater becomes unfrozen again. Recharge of meteoric and seasonally warm melt water through 'talik' and colluvial materials, also possibly through preferential flow networks in fracture zones can be important controls over the hydrogeological water balance and flow mechanisms, potentially resulting in deeper groundwater occurrence than otherwise suggested by the nominal thickness of permafrost present.

The depth to a permanent groundwater water table is reported to be 300 to 500m (ERM, 2014) depending on location and aquifer type. The overall groundwater system is consistent with typical Siberian groundwater regimes with deep, confined groundwater held within generally reducing permeability fractured rocks at depth and a dynamic near surface (active zone or supra-permafrost) system which cycles significant quantities of groundwater through 'talik' and alluvial water 'bequaring' zones with baseflow and spring discharge. Groundwater is reported to be a bicarbonate-sodium type with low mineralization. Recharge rates are reported to be 1 L/sec per 1km<sup>2</sup> (8.7E<sup>-5</sup>m/day). The total spring discharge rate was estimated at 36m<sup>3</sup>/second. Hydrometeorological surveys carried out in September 2015 representing the annual lowest flow period are shown in Figure 16.2.



Hydrographic Monitoring Point 1. Porfirovoy Creek. Flow  $0.11\text{m}^3/\text{sec}$



Hydrographic Monitoring Point 2. Borisovsky Creek. Flow  $0.01\text{m}^3/\text{sec}$



Hydrographic Monitoring Point 3. Sirilendzhe River. 25km downstream Flow 3.08m<sup>3</sup>/sec

**Figure 16.2: Project Surface Water Systems (photos and flow records courtesy of Nerungristroyresearch, Vol. 3 Book 1 (Hydrometeorology), April 2016)**

#### 16.2.2.3 Sources of Information

The principal source of hydrogeological information has been an SRK study included within the Tetra Tech 2017 competent persons technical report. The objective of the SRK work was to develop an understanding of mine hydrogeology, assess dewatering requirements and assess the usability of a sub-permafrost aquifer to supply the mine with water.

The overall information and data sources reviewed includes:

- Tetra Tech, 2017. NI 43-101 Technical Report, Mangazeisky Silver Project, Republic of Sakha (Yakutia), Russian Federation Document No. 1454430200-REP-R0006-02.
- SRK Consulting (UK) Limited, 2016, Project No.U6065 Appendix K of the NI 43-101 Technical Report: Hydrogeology.
- ERM, October 2014, Scoping Report, Mangazeisky Project: Environmental and Social Impact Assessment, Project №0264539
- Nerungristroyresearch, Vol. 3 Book 1 (Hydrometeorology), April 2016. Technical report on engineering and hydrometeorological research. Ref. 497-75/14-IGM.

(Filepath: N:\RU\RU10139 - Mangazeiskiy silver project\02 - Data\Incoming\IN ENGLISH\SBR-WAI DATA ROOM\Технический\_проект\_Вертикальное\вертикальное\_огр\изыскания\ИГМИ\Отчет.Досх)

- Non-orientated core logging sheets for geotechnical borelogs 14B – 191 (Filepath: N:\RU\RU10139 - Mangazeiskiy silver project\02 - Data\Incoming\IN ENGLISH\SBR-WAI DATA ROOM\документация скважин\Геотех-кая Док-ция Geotechnical Log V11-191.xls inter alia)
- Nerungristroyresearch, Vol. 2, Book 3, Part 1, (Geophysics and Geological Survey), April 2016. (Filepath N:\RU\RU10139 - Mangazeiskiy silver project\02 - Data\Incoming\IN ENGLISH\SBR-WAI DATA ROOM\Технический\_проект\_Вертикальное\ вертикальное\_огр\ изыскания\ИГИ\ 497-75-14-ИГИ-Книга 3\_изм2\_Часть\_1.pdf)
- Nerungristroyresearch, Vol. 2, Book 1, (Geological Engineering), April 2016. (Filepath N:\RU\RU10139 - Mangazeiskiy silver project\02 - Data\Incoming\Report on Geology\ТОМ 2

### **16.2.3 Pit Geometries and Interaction with Groundwater**

The deposit has an exceptionally narrow geometry and necessitates a pit design and mining method that is highly optimised to minimise mine wastes and control grades. The pit design and optimisation has been based on SRK geotechnical studies and slope configuration results (Tetra Tech, 2017, Appendix B). Sensitivity analysis on the selected pit shells (base case) shows the overall financial model is relatively insensitive to mining and processing costs and most sensitive to grade control (Tetra Tech, 2017). Consequently, the steep (vertical) mineralisation promotes a constrained mining method to access ore and maintain integrity of the mine structures. Calculated overall strip ratio for the operation is 25. Overall slope angle is defined by bench and berm geometry and inter-ramp angles (IRAs) which, in line with kinematic and rock fall analysis has resulted in a maximum IRA of 56° recommended for the hanging wall and 48° for the footwall. Steeper slopes will start to undercut the bedding on an inter-ramp scale (instability).

The deposit will be mined in a north zone (Mangazeisky) by open pit, and a central zone approximately 6km south-southwest named Vertikalny which will be mined by open pit and underground methods. Vertikalny will comprise a sequence of four individual pits developed along strike of the mineralised vein with underground mining commencing beneath the main part of the central zone with the final underground drive (Zone 4) extending northwards.

The Mangazeisky pit has an overall strike length of 650m, maximum width of 250m, and a pit floor elevation of 1084m. Vertikalny will be developed as four pits along strike, the pits range from Pit 2 (smallest) with dimensions of 50m width and 120m length to the largest (Pit 4) in the northwest which is 145m width and 530m length. The respective floor elevations of these pits are 1117m Above Datum (AD) and 1094mAD.



Underground mining will occur through sub-level open stoping, with remote stope cleaning extending below the open pits with mine access portals located above invert levels of the surface water systems and open water accumulations in the pits. The underground mine will comprise 25m vertically spaced mining levels, the planned underground mining depths are approximately 950mAD in underground zones 2, 3 and 1 which correspond to pits 4, 3 & 2 and 1 respectively. Zone 4 is a northward extension beyond the Vertikalny open pit footprint. Zone 1 in the southern section of the deposit is the deepest underground section and is planned to extend to 700mAD. Generally, the maximum depth of the underground section is approximately a 150m deeper than the base level of the overlying open pit. In zones 1 and 4 of Vertikalny, the maximum depth of the underground mine below ground surface is approximately 300m. Given the long-term tendency for permafrost thickness reduction, the lower levels of these zone should conservatively be assumed to be in sub-permafrost (free-flowing water) conditions.

#### **16.2.4 Groundwater Control and Management**

SRK prepared an open pit and underground geotechnical study in support of the Tetra Tech NI 43-101 study (Figure 16.3) in which it was noted that ground conditions *“are generally good with no special measures required for orebody extraction”*. SRK also completed a feasibility-level hydrogeology and water supply study for the Mangazeisky Project with two main objectives to assess the potential inflows of water into the mine and evaluate the water supply potential of the sub-permafrost aquifer.

Site investigations focused on the hydrogeology of the mine location and the sub-permafrost aquifer along the main Sirilendzhe River, where the permafrost layer is expected to be thinner and the potential for water supply from the sub-permafrost aquifer higher. SRK noted with respect to hydrogeology that the open pits and underground mines are *“entirely located in the permafrost; therefore, groundwater inflow into the mine workings, if any, will be negligible.”* SRK appraised the surface water (precipitation) based inflows to the pits and deduced a pumping capacity to deal with average flow of 100m<sup>3</sup>/hour would also need to be able manage 200m<sup>3</sup>/hour inflows for exceptional (1 in 100 year) storm events. It was noted that the Siberian conditions mean that water is unfrozen only in late spring and summer (April to October).

SRK also investigated the permafrost distribution within the proposed mine site using two deep boreholes (VG-2 and G-1) which were equipped with thermistors. Temperature measurements were taken downhole several times and whilst the boreholes did not traverse the full thickness of the permafrost, extrapolation was possible.

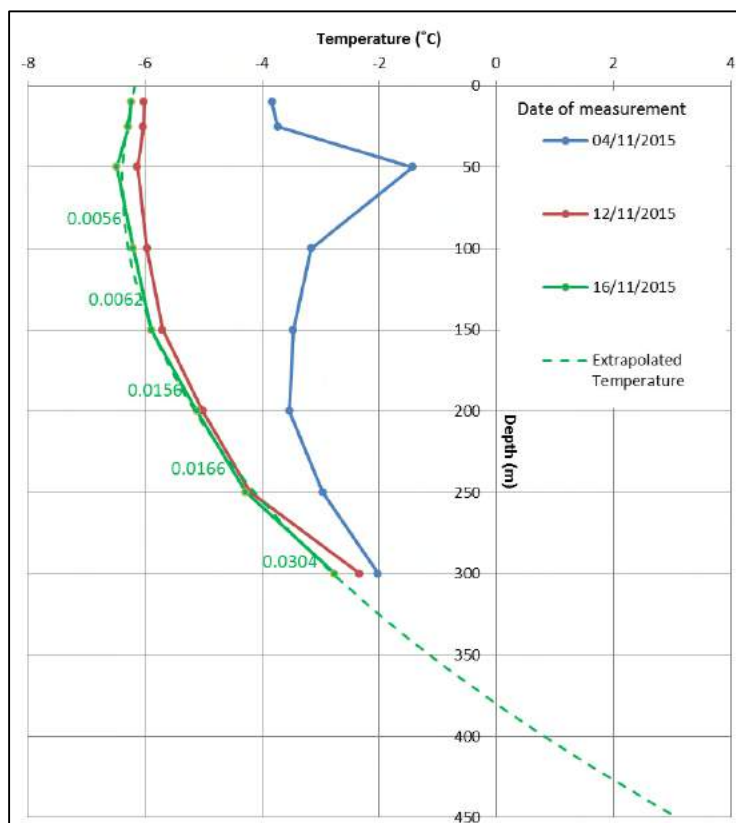


Figure 16.3: Underground Mine Layout (Tetra Tech, 2017)

The depth to the bottom of the permafrost was assessed by SRK who identified this could be 380-400m in the interfluvial area of the mine and between 157 – 220m deep in the area of the stream valleys.

### 16.2.5 Groundwater Supply

Surface water is unable to provide a reliable water supply source to the mine due to strongly seasonal hydrographic variations and prolonged freezing periods. SRK, 2016 evaluated a sub-permafrost groundwater source of water:

“For the purpose of the water supply investigation, four boreholes were drilled along the Sirilendzhe River, which traversed the full thickness of the permafrost layer and reached the aquifer beneath. The boreholes showed artesian flow, with water levels ranging from 1.1m to 14m above the ground level. Pumping tests were completed on three of the four boreholes, to estimate the hydraulic parameters of the aquifer. The fourth borehole, which is drilled near the current camp at the junction of Porfirovy Stream and Sirilendzhe River and labelled GS15-05, was not pumped because the artesian water outflow was higher than the capacity of the pump available on site at the time. In addition to the high-water flow, this borehole also showed the best water quality among all four boreholes, and seems the most suitable for the Project water supply. Therefore, the location of this borehole is recommended by SRK as the most appropriate site for water supply well installation.”

SRK undertook modelling (including development of a finite element numerical model) based on the limited field data available. The modelling used hydraulic conductivity and specific storage properties from the results of pumping and recovery tests conducted in the hydrogeological boreholes. Values used in the model appear to be realistic and there is a variability of an order of magnitude ( $K = 0.78\text{m/d}$ ) to account for higher flow in a fault zone. Modelling results indicated a sustainable supply of water for the life of mine for three different groundwater pumping scenarios, wherein rates and duration of pumping were altered to match the annual demand requirements ( $\pm$  input for 4 months from surface flow when available).

- The assumption that the underground mine will be located fully in the permafrost zone and groundwater inflows into the mine workings, if any, would be negligible (SRK 2016) appears to have been disregarded by the mine designers and contradicts a statement in the Geotechnical report (Appendix B) which states some of the underground workings may be in the sub-permafrost water bearing zone. Tetra Tech 2017 assumes the underground mine will need a drainage system comprising collection sumps in each underground mine situated at the lowest adit level receiving uncaptured drainage from the levels above. Drainage from ramps, raises, drain holes and stopes is designed to report to the sumps. The gradients of the main drives and levels of the underground development are designed to facilitate gravity drainage from the mine towards adits to avoid flooding.
- The potential for underground mine inflow needs to be confirmed and re-appraised using suitably conservative assumptions.

Surface water hydrology and the mine water balance have been reviewed and no additional comments over and above what has already been presented by SRK are raised.

## **16.3 Geotech**

### **16.3.1 Introduction**

WAI has carried out a review of the geotechnical information provided by SBR for the Vertikalny and Mangazeisky North deposits.

Information was collected from the findings of the geotechnical study carried out by SRK Consulting (SRK)<sup>1</sup> in late 2014 for the Vertikalny deposit. The review has aimed to summarise the geotechnical parameters for use in mine optimisation and design in support of the strategic review for the Mangazeisky Silver Project.

---

<sup>1</sup> SRK Consulting (UK) Limited, 2015. Geotechnical Feasibility Study Report on Open Pit and Underground Mining for the Vertikalny Deposit

### **16.3.2 Vertikalny Deposit**

#### *16.3.2.1 Geotechnical Data Collection*

A geotechnical drilling campaign was initiated in late 2014 in support of the SRK geotechnical study. The campaign included the drilling and geotechnical logging of eight diamond cored boreholes for open pit analysis. Additional geotechnical data was gathered from several previous exploration and resource drilling campaigns and used to substantiate the SRK study.

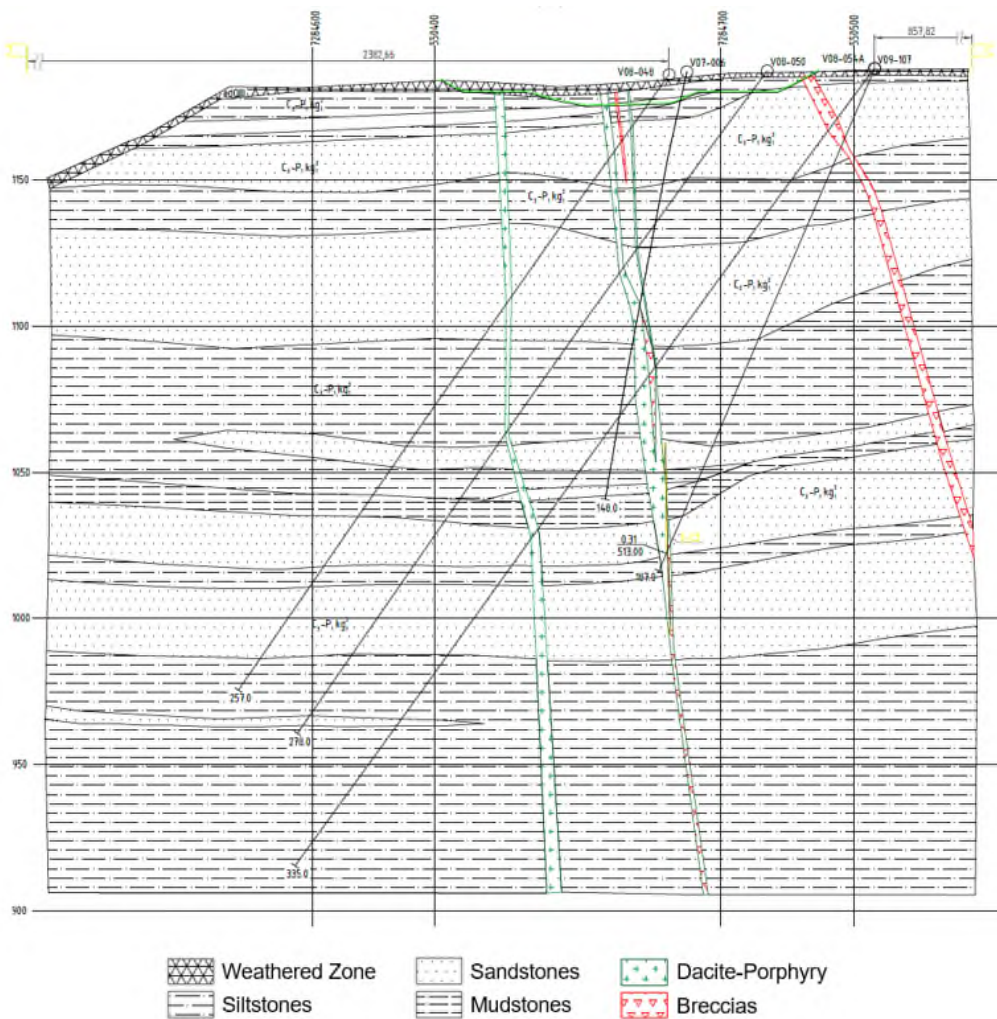
#### *16.3.2.2 Rock Mass Characterisation*

#### *16.3.2.3 Lithological Description*

The Vertikalny rock mass is overlain by thin layer of overburden and highly weathered rock; generally, less than 10m in thickness. Beneath this zone, the rock mass is primarily composed of alternating sandstone and sandy-siltstone sequences. The sandstone sequences are reported to be unweathered and have well-defined bedding planes. A cross-section prepared by EMC Mining<sup>2</sup> which provides an indicative representation of the Vertikalny rock mass is presented in Figure 16.4.

---

<sup>2</sup> EMC Mining, 06/2015 - «Проект строительства горноперерабатывающего комплекса на базе месторождения «Вертикальное» - Площадка №1. Карьер и отвалы - Геологический разрез по линии 10700



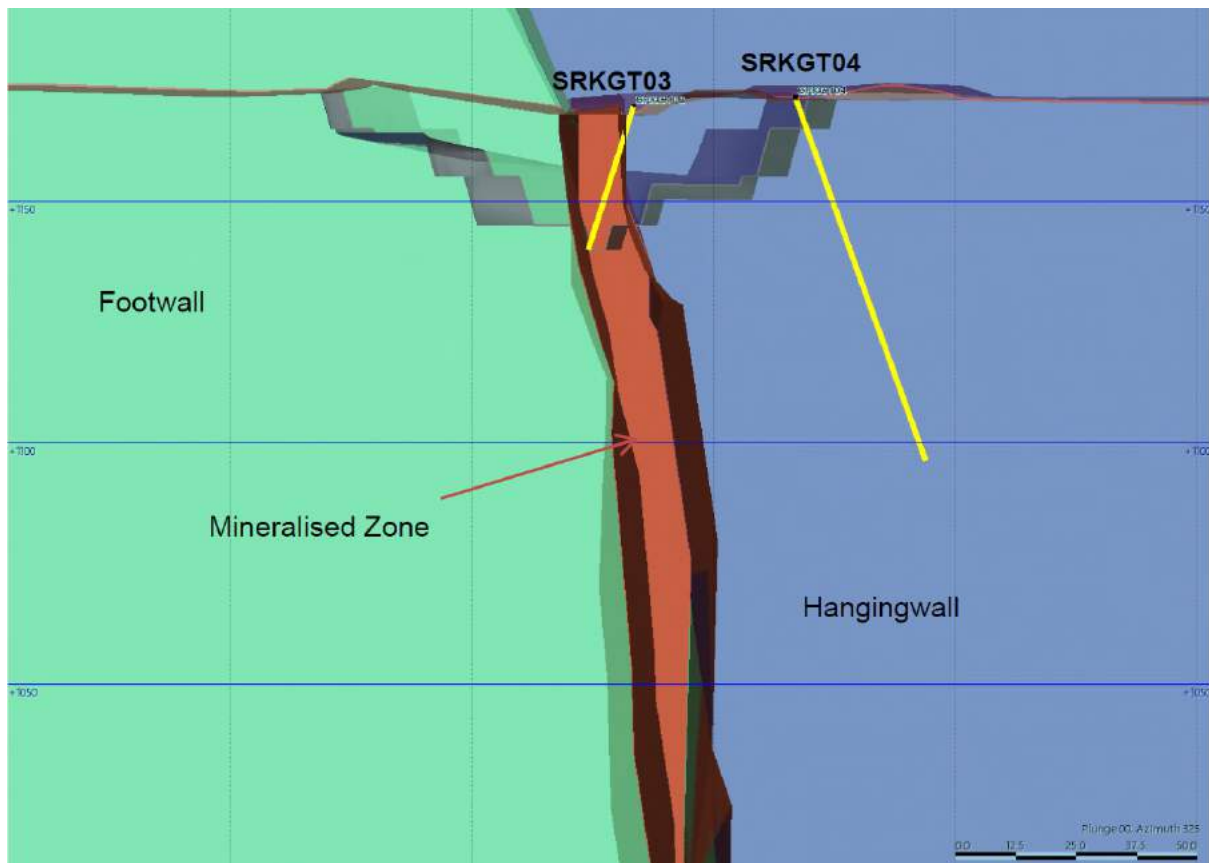
**Figure 16.4: Vertikalny Rock Mass Composition**

#### 16.3.2.4 Geotechnical Domains

The SRK study notes that the major lithologies have minor variations in rock mass characteristics between one another. Consequently, the geotechnical domains were defined according to the to the mining domains:

- Hanging wall;
- Footwall; and
- Mineralised zone.

SRK generated three-dimensional models of each domain which were used to perform statistical analyses on the key geotechnical parameters. A cross section representing the three domains is presented in Figure 16.5.



**Figure 16.5: Vertikalny Geotechnical Domain Cross-Section (SRK Geotechnical Study)**

#### 16.3.2.5 Rock Mass Classification

Open pit and underground rock mass classification was carried out using the  $RMR_{89}^3$  and Barton's  $Q^4$  classification system, respectively. Detail regarding the methodologies and results of the rock mass classification exercise may be found in the SRK geotechnical study.

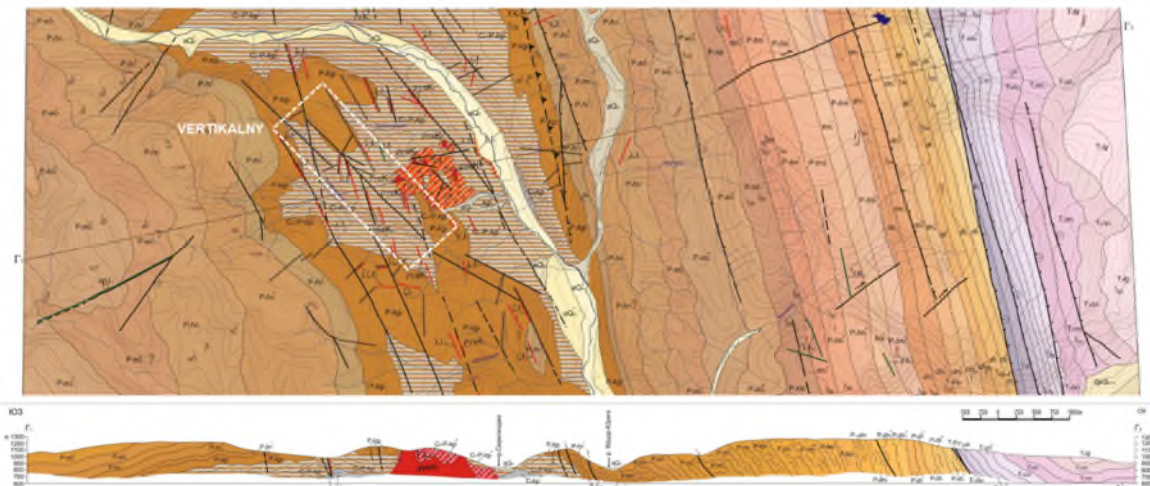
#### 16.3.2.6 Major Structural Features

WAI is unaware of the availability of any large-scale three dimensional structural/fault models for the Vertikalny deposit. Regional geological maps indicate a series of steeply dipping structures which strike sub-parallel to the mineralisation. A geological map (modified after EMC Mining<sup>5</sup>) indicating these features relative to the Vertikalny deposit is presented in Figure 16.6.

<sup>3</sup> Bieniawski, Z.T. 1989. Engineering rock mass classifications. New York: Wiley

<sup>4</sup> Barton, N.R., Lien, R. and Lunde, J. 1974. Engineering classification of rock masses for the design of tunnel support. Rock Mech. 6(4), 189-239.

<sup>5</sup> EMC Mining. 06/2015 - «Проект строительства горноперерабатывающего комплекса на базе месторождения «Вертикальное» - Площадка №1. Карьер и отвалы -Геологический разрез по линии 10700 Масштаб 1:1000



**Figure 16.6: Regional Geological Map**

SBR have not indicated the presence of any major structural features intersecting the current open pit. Any features that are intersected are assumed to be mapped and managed operationally. An understanding of the location and engineering properties of these features is essential in identifying any potential instabilities within the open pit and future underground operations.

#### *16.3.2.7 Groundwater Conditions*

The Mangazeisky Project area has permafrost layer of 300m to 400m in thickness. Groundwater inflows are not considered to play a major role in open pit or underground stability. WAI notes that localised thawing of the rock mass may occur during excavation of the open pit and potential underground workings.

#### *16.3.2.8 Open Pit Geotechnical Review*

#### *16.3.2.9 Kinematic Analysis*

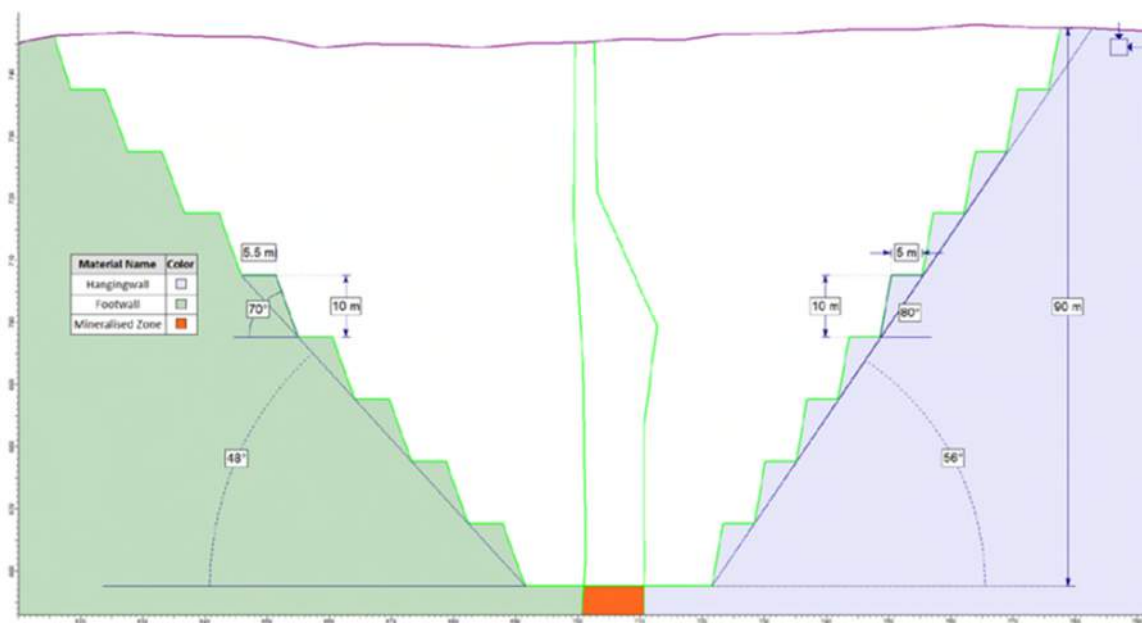
SRK carried out a detailed kinematic stability analysis to determine the appropriate berm width and bench face angles for the given structural conditions. Kinematic analysis of wedge, planar and toppling type failures were assessed for the hanging wall and footwall rock masses.

Analysis of the footwall rock mass suggests that bench scale planar instabilities are likely to exist. Inter-ramp angles (IRA) were set at 48° to avoid undercutting the bedding and minimise potential multi-bench instabilities. The hanging wall was noted to have favourable structural geometries and able to support a steeper IRA of 56°. No special measures were noted for the excavation of the relatively shallow overburden and weathered rock zone.

Additional detail regarding the methodologies and results of the kinematic analysis may be found in the SRK geotechnical study.

### 16.3.2.10 Numerical Analysis

SRK carried out an assessment of open pit slope stability using the RocScience Phase2 finite element (FE) modelling software package. The software allows for the calculation of the Strength Reduction Factor (SRF); a measure broadly equivalent to Factor of Safety (FOS). Modelling was carried out on the deepest section of the proposed pit to produce the lowest SRF (FOS). Mine geometries were defined using the slope parameters identified in kinematic analysis. The cross-section tested in FE modelling is presented in Figure 16.7.



**Figure 16.7: Finite Element Modelling Slope Geometry**

Rock mass strength was modelled by domain using the Hoek-Brown strength criterion. The results of the FE stability modelling are presented in Table 16.1.

<b>Table 16.1: Finite Element Stability Analysis Results</b>		
<b>Domain</b>	<b>Strength Reduction Factor</b>	<b>Probability of Overall Slope Failure</b>
Hanging Wall	2.31	0.02%
Footwall	2.39	0.11%

The results clearly indicate that the rock mass can support the proposed mining geometries. Further detail regarding the inputs and methodologies used in the FE modelling may be found in the SRK geotechnical report.



### 16.3.2.11 Pit Slope Design Criteria

The recommended pit design parameters identified in the SRK study are summarised in Table 16.2.

Domain	Bench Height	Bench Face Angle	Berm Width	Inter-Ramp Angle
	(m)	(°)	(m)	(°)
Hanging Wall	10	80	5	56
Footwall	10	70	5.5	48

### 16.3.3 Underground Geotechnical Review

#### 16.3.3.1 Mining Method

Previous studies have suggested the application of several underground mining methods for the Vertikalny deposit. The two main candidates include:

- Shrinkage stoping (SRK geotechnical study); and,
- Sublevel longhole open stoping (Tetra Tech technical report<sup>6</sup>)

WAI propose to maintain the mining methodology outlined by Tetra Tech; mechanised sub-level open stoping. The method offers favourable results in safety, cost and dilution control. Stopes will be extracted in a retreat, top-down sequence, with adequate in-situ rock pillars left unmined for localised and regional stability.

#### 16.3.3.2 Stope Wall Stability

The SRK study analysed a range of empirically derived stope dimensions determined through the Mathews (Mathews *et al.* 1981<sup>7</sup> and updated by Potvin 1988<sup>8</sup>) stability graph method. The stope dimensions proposed by Tetra Tech, and utilised by WAI, are as follows:

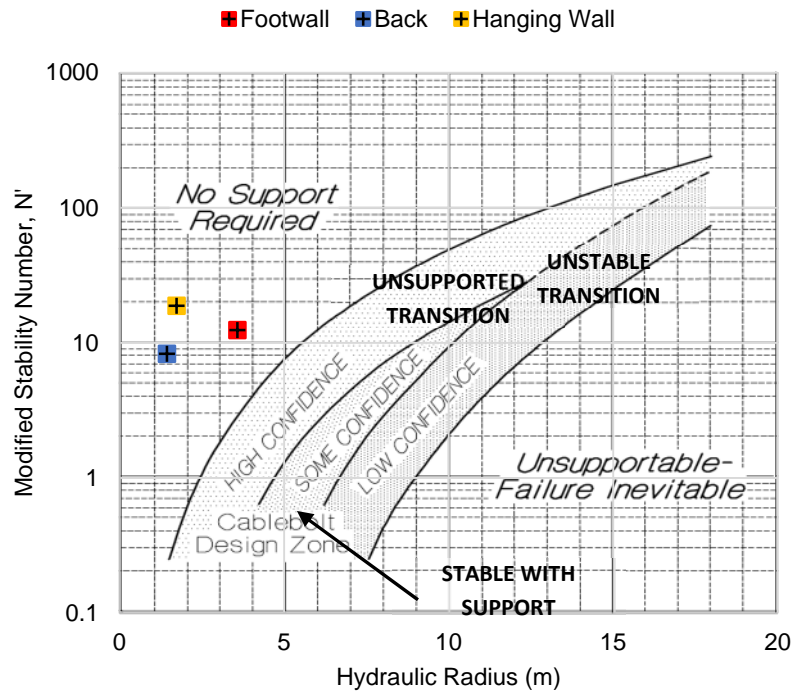
- Strike length: 10m
- Wall height: 25m
- Span: 4m

<sup>6</sup> Tetra Tech 2017. NI 43-101 Technical Report, Mangazeisky Silver Project, Republic of Sakha (Yakutia), Russian Federation

<sup>7</sup> Mathews, K.E., Hoek, E., Wyllie, D.C. and Stewart, S.B.V. 1981. Prediction of stable excavations for mining at depths below 1000m in hard rock. CANMET Report. DSS Serial No. OSQ80-00081, DSS File No. 17SQ. 23440-0-9020 Ottawa. Dept. Energy, Mines and Resources.

<sup>8</sup> Potvin, Y. 1988. Empirical open stope design in Canada. PhD thesis. Vancouver. Dept Mining & Minerals Processing, Univ British Columbia.

Based on SRK’s stope stability results, these dimensions plot within the ‘stable’ zone of the stability graph. A plot of the design surfaces on the stability graph is presented in Figure 16.8.



**Figure 16.8: Stability Graph for Proposed Open Stop Dimensions**

For the given wall height and maximum stope span, stope strike lengths may extend up to 20m before the footwall design surface plots within the ‘unsupported transitional’ zone of the stability graph. This indicates the approximate spacing at which in-situ rock pillars (rib pillars) would be required to maintain stability. Stope pillar dimensions and spacings have not been defined in the study.

Detail regarding the methodologies and results of the stope stability analysis may be found in the SRK geotechnical study.

### 16.3.3.3 Crown Pillar Stability

The empirical Scaled Span method (Carter 2014<sup>9</sup>) was used by SRK to assess the required crown pillar dimensions to promote safe workings between the open pit and underground operations. The method draws from a crown pillar database containing over 500 case records with 70 analysed failures.

The SRK study modelled various pillar thicknesses for both shrinkage and open stoping. WAI has utilised the shrinkage stoping results as the modelled pillar spans of 3m closely match the maximum proposed stope span of 4m. A crown pillar thickness of 15m was selected as it provides a good factor

<sup>9</sup> Carter, T.G., 2014. Guidelines for use of the Scaled Span Method for Surface Crown Pillar Stability Assessment. Golder Associates, Toronto, Canada.

of safety and low probability of failure. This figure is comparable to the dimensions utilised in the Tetra Tech design work which range from 10m to 15m.

Detail regarding the methodologies and results of the crown pillar stability analysis may be found in the SRK geotechnical study.

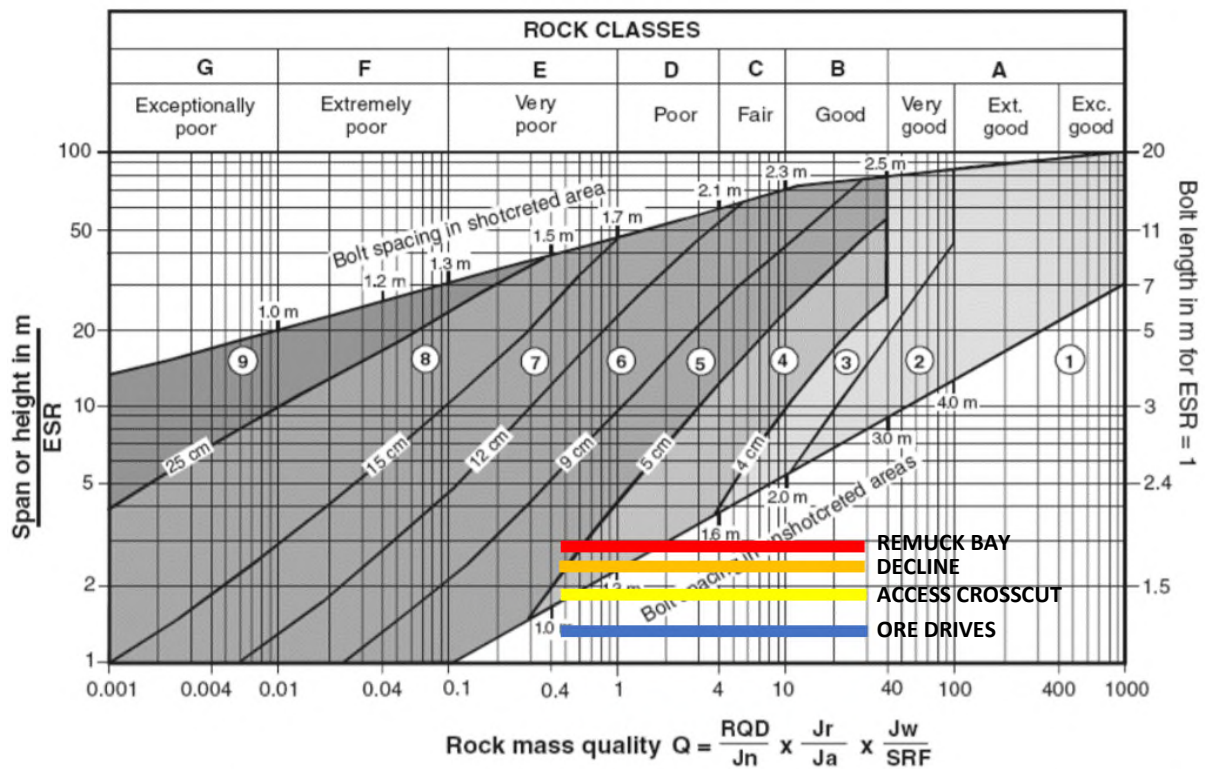
#### 16.3.3.4 Ground Support

The SRK study estimated ground support requirements by use of Barton's Q system. A set of fixed excavation spans were tested against a range of rock mass Q values and assessed on Barton's Q support chart. The Q values tested by SRK include the 10<sup>th</sup>, 50<sup>th</sup> and 90<sup>th</sup> percentile Q values generated from logging. The excavations categories assessed included access crosscuts, ore drives and undercut drives.

WAI notes that the maximum excavation span tested by SRK was 2.5m. This differs from excavation spans recommended by Tetra Tech; summarised in Table 16.3.

<b>Excavation Category</b>	<b>Span (m)</b>	<b>Height (m)</b>
Access Decline	3.8	3.2
Remuck Bay	4.5	4.5
On-Vein Drive	3.2	3.0
Level Access Drive	3.0	3.0

WAI has compared the spans presented in Table 16.3 against the rock mass parameters utilised by SRK. An updated Q support chart is presented in Figure 16.9,.



**REINFORCEMENT CATEGORIES:**

- |  |  |
|--|--|
| 1) Unsupported   | 6) Fibre reinforced shotcrete and bolting, 9 – 12 cm                                     |
| 2) Spot bolting  | 7) Fibre reinforced shotcrete and bolting, 12 -15 cm                                     |
| 3) Systematic bolting  | 8) Fibre reinforced shotcrete, >15 cm, reinforced ribs of concrete shotcrete and bolting |
| 4) Systematic bolting, (and unreinforced shotcrete, 4 – 10 cm) | 9) Cast concrete lining  |
| 5) Fibre reinforced shotcrete and bolting, 5 – 9 cm            |  |

**Figure 16.9: Q Support Chart (UG Development)**

Most of the excavation categories plot within the unsupported zone of the Q support chart for the given range of Q values. A combination of systematic bolting and shotcreting may be required for excavations located in poorer rock mass conditions and must be assessed on an operational basis. For the purposes of ground support cost estimation, WAI have assumed that 20% of the excavations will require support.

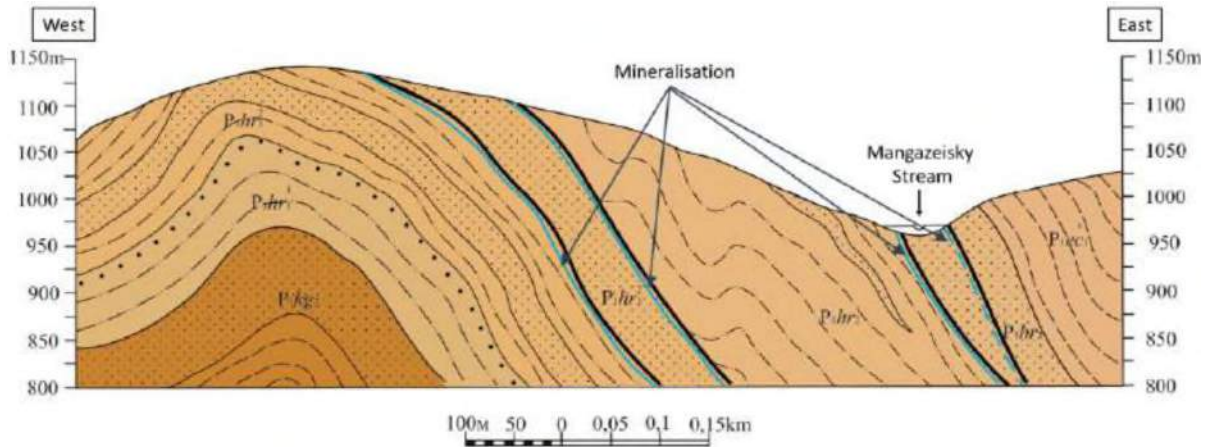
**16.3.4 Mangazeisky North Deposit**

**16.3.4.1 Geotechnical Data**

Limited geotechnical data is available for the Mangazeisky North deposit. Rock mass strength parameters have been assumed equivalent to those at the Vertikalny deposit.

### 16.3.4.2 Rock Mass Structure

The Mangazeisky North rock mass consists of interbedded siltstone, sandstone and argillite. Geological descriptions suggest that the area is dominated by a north-north west south-south east striking anticlinal fold. Bedding planes and mineralisation are noted to dip between 20 and 40° towards the East. A generalised cross-section through the Mangazeisky North deposit is presented in Figure 16.10.



**Figure 16.10: Mangazeisky North Rock Mass Cross-Section**

### 16.3.4.3 Proposed Pit Design Criteria

A summary of the design criteria proposed by WAI for pit optimisation and design is provided in Table 16.4.

Table 16.4: Pit Design Parameters			
Bench Height	Bench Face Angle	Berm Width	Inter-Ramp Angle
(m)	(°)	(m)	(°)
10	70	6.4	45

These parameters are based on a standard WAI base case and have not been determined from geotechnical analysis. The parameters may not present an optimal set of criteria and should be treated as indicative only.

## 16.4 Net Smelter Return Model

The Vertikalny and Mangazeisky North deposits are polymetallic with the main elements being silver, lead and zinc.

The current ore processing circuit is optimised for oxide mineralisation only and produces silver as the sole product. A key strategic consideration is the potential implementation of a flotation plant capable of processing the sulphide mineralisation. Three products would be produced from such a plant:

- Zinc concentrate;
- Lead concentrate; and
- Silver (from Lead/Silver middlings).

A basic net smelter return (NSR) calculation was performed which considered grade, metal price, metallurgical recovery, and metal payability. The payable metal includes the applicable concentrate and refining charges but does not include price participation or penalty element payments. The metal price assumptions were derived by WAI and approved by SBR. All metallurgical recoveries/costs used in the NSR calculation are based on data provided by SBR.

WAI notes that only the sulphide blocks consider the value contributions of each payable element. This is based on the premise that most of the sulphide blocks will be processed through a flotation plant; following depletion of the oxide blocks which form a relatively contiguous volume within the current Vertikalny pit. Oxide blocks only considered the value contribution of silver.

The NSR model forms a critical input into the development of this mining study and further detail regarding the NSR inputs must be understood to enhance the confidence of the study.

#### **16.4.1 NSR Factors**

NSR factors were calculated and directly applied to each block within the Resource block models enabling the subsequent mine optimisation exercises to be carried out on the block NSR values. The inputs and calculations used to derive the NSR factors are presented below.

**SULPHIDE NSR ASSESSMENT**

**Feed**

Parcel	1000 kg
Ag	1000 g/t
Pb	2.03 %
Zn	1.73 %

**Metal Prices**

**SP ANGEL (27.08.19)**

Ag	17.76 US\$/tOz
Pb	2,069 US\$/t
Zn	2,252 US\$/t

**Charges**

Transport	274.9 US\$/tconc
Treatment	0 US\$/tconc
Refining	0.4 US\$/tOz

ZINC CONCENTRATE		
<b>Mill Recovery</b>		
Zn	82.2 %	
Ag	4.7 %	
<b>Contained Metal</b>		
Zn	14.2 kg	
Ag	47.0 g	
<b>Concentrate</b>		
Zn	42.3 %	
Ag	1398 g/t	
Mass	33.6 kg	
	<b>Zn</b>	<b>Ag</b>
Deductions	0 %	0 g
Payability	45 %	45 %
<b>Value</b>	<b>14.41 US\$/t<sub>ORE</sub></b>	<b>12.08 US\$/t<sub>ORE</sub></b>
Transport Cost	9.24 US\$/t <sub>ORE</sub>	0.00 US\$/t <sub>ORE</sub>
Treatment Cost	0.00 US\$/t <sub>ORE</sub>	0.00 US\$/t <sub>ORE</sub>
Refining Cost	0.00 US\$/t <sub>ORE</sub>	0.60 US\$/t <sub>ORE</sub>
<b>Total Costs</b>	<b>9.24 US\$/t<sub>ORE</sub></b>	<b>0.60 US\$/t<sub>ORE</sub></b>
<b>Value (Less: Total Costs)</b>	<b>5.17 US\$/t<sub>ORE</sub></b>	<b>11.47 US\$/t<sub>ORE</sub></b>
Ore:Concentrate	29.75	29.75
Conc. Value	153.77 US\$/t <sub>CONC</sub>	341.25 US\$/t <sub>CONC</sub>
Feed Grade	1.73 %	1000 g/t
NSR Factor	2.99 US\$ / % / t	0.011 US\$ / g / t
<b>NSR for 1t of Ore from Zn Conc.</b>	<b>16.64 US\$/t<sub>ORE</sub></b>	

LEAD CONCENTRATE		
<b>Mill Recovery</b>		
Pb	65.9 %	
Ag	65.0 %	
<b>Contained Metal</b>		
Pb	13.4 kg	
Ag	650.0 g	
<b>Concentrate</b>		
Pb	17.1 %	
Ag	8309 g/t	
Mass	78.2 kg	
	<b>Pb</b>	<b>Ag</b>
Deductions	0 %	0 g
Payability	84 %	84 %
<b>Value</b>	<b>23.25 US\$/t<sub>ORE</sub></b>	<b>311.76 US\$/t<sub>ORE</sub></b>
Transport Cost	21.51 US\$/t <sub>ORE</sub>	0.00 US\$/t <sub>ORE</sub>
Treatment Cost	0.00 US\$/t <sub>ORE</sub>	0.00 US\$/t <sub>ORE</sub>
Refining Cost	0.00 US\$/t <sub>ORE</sub>	8.36 US\$/t <sub>ORE</sub>
<b>Total Costs</b>	<b>21.51 US\$/t<sub>ORE</sub></b>	<b>8.36 US\$/t<sub>ORE</sub></b>
<b>Value (Less: Total Costs)</b>	<b>1.74 US\$/t<sub>ORE</sub></b>	<b>303.41 US\$/t<sub>ORE</sub></b>
Ore:Concentrate	12.78	12.78
Conc. Value	22.29 US\$/t <sub>CONC</sub>	3878.27 US\$/t <sub>CONC</sub>
Feed Grade	2.03 %	1000 g/t
NSR Factor	0.86 US\$ / % / t	0.303 US\$ / g / t
<b>NSR for 1t of Ore from Pb Conc.</b>	<b>305.15 US\$/t<sub>ORE</sub></b>	

LEAD/SILVER MIDLINGS		
<b>Mill Recovery</b>		
Ag	15.6 %	
<b>Contained Metal</b>		
Ag	156 g	
Payability	98 %	
<b>Value</b>	<b>87.29 US\$/t<sub>ORE</sub></b>	
<b>Refining Cost</b>	<b>2.01 US\$/t<sub>ORE</sub></b>	
<b>NSR for 1t of Ore from Ag/Pb M</b>	<b>85.29 US\$/t<sub>ORE</sub></b>	
<b>NSR Factor</b>	<b>0.09 US\$ / g / t</b>	

SULPHIDE NSR FACTORS		
Ag	0.40 US\$ / g / t	
Pb	0.86 US\$ / % / t	
Zn	2.99 US\$ / % / t	

<b>Total NSR</b>	<b>407.08 US\$/t<sub>ORE</sub></b>
------------------	------------------------------------

**NOTE: Concentrate assumed at 0% moisture.**

OXIDE		NSR ASSESSMENT
<b>Feed</b>		
Parcel		1000 kg
Ag		1000 g/t
Pb		2.03 %
Zn		1.73 %
<b>SILVER PRECIPITATE</b>		
Mill Recovery	Ag	85 %
Contained Metal	Ag	850 g
Payability		98 %
Value		475.64 US\$/t <sub>ORE</sub>
Refining Cost		10.93 US\$/t <sub>ORE</sub>
<b>Value (Less:Costs)</b>		<b>464.71 US\$/t<sub>ORE</sub></b>
<b>OXIDE NSR FACTOR</b>		<b>0.46 US\$ / g / t</b>

## 16.5 Mineable Tonnes

Table 16.5 to Table 16.7 summarise the mineable inventories for all areas.

Rock Type	Economic Cut-Off	Classification	Tonnage
Oxide Material	Above Cut-Off NSR >= 117.00 US\$/t	Measured	58,850
		Indicated	113,178
		Inferred	-
	Total Below Cut-Off NSR < 117.00 US\$/t	Measured	172,028
		Indicated	16,587
		Inferred	19,847
Total Oxide	Measured	-	
	Indicated	75,436	
	Inferred	133,025	
Sulphide Material	Above Cut-Off NSR >= 113.06 US\$/t	Measured	11,405
		Indicated	75,378
		Inferred	7,443
	Below Cut-Off NSR < 113.06 US\$/t	Measured	1,748
		Indicated	21,319
		Inferred	454
Total Sulphide	Measured	13,153	
	Indicated	96,697	
	Inferred	7,897	
Total Above Cut-Off			258,811
<b>Total Mineable Tonnes</b>			<b>326,208</b>



Rock Type	Economic Cut-Off	Classification	Mineralised Tonnage	Mineralised Tonnage with Planned Dilution
Stope	Stope Cut-Off NSR $\geq$ 142 US\$/t	Measured	-	-
		Indicated	255,966	291,124
		Inferred	287,080	326,512
		<b>Sub-Total</b>	<b>543,046</b>	<b>617,636</b>
On-Vein Drive	No Cut-Off	Measured	-	-
		Indicated	67,366	117,610
		Inferred	65,239	113,897
		<b>Sub-Total</b>	<b>132,604</b>	<b>231,507</b>
Total		Measured	-	-
		Indicated	323,332	408,735
		Inferred	352,319	440,409
		<b>Total</b>	<b>675,650</b>	<b>849,144</b>

\* Unplanned dilution (10%) and mining recovery (90%) not applied to stopes

\* Planned dilution (waste within stopes and on-vein drives) added to mineralised tonnes on pro rata basis.

Sulphide Material	Above Cut-Off NSR $\geq$ 113.06 US\$/t	Measured	-
		Indicated	-
		Inferred	280,805
	Below Cut-Off NSR $<$ 113.06 US\$/t	Measured	-
		Indicated	-
		Inferred	58,463
	<b>Total</b>	Measured	-
<b>Inferred</b>		<b>339,268</b>	

The mineable inventories represent all resources that have the potential to be economic in the future as upside in the scoping study for long term financial forecasting. WAI has and based conceptual open pit designs and a combined conceptual design on the in-pit and underground inventories.

The in-pit MRE is based on a set of cost parameters supplied by the Client which align with its actual current costs of production, G&A (\$60/t) and oxide processing costs (\$72.91/t). The wireframe resource model was done at 50g/t Ag COG and includes mineralisation with grade between 75-240g/t Ag (and which is the subject of using XRT separation) so all potentially economic mineralisation is captured. These resources are at a satisfactory level of confidence that best reflect the economic conditions under the set of parameters given by SBR and, as there has been no addition of evaluation data since, best reflect the current state of SBR's resources.

The mineable tonnage estimate is based on a more optimistic set of cost parameters developed downstream to the MRE and considered for the future conceptual design. The latest mineable tonnes estimates utilise optimistic optimisation cost parameters; G&A at \$40/t and oxide processing at \$50/t.

The main differences as a result of the different optimisation parameters are that the volumes reported in the MRE (lower estimate) are based on a physically smaller set of pit shells and higher cut-off grades due to the higher optimisation costs.

Consequently, the MRE and mineable tonnes estimates for Vertikalny cannot be directly compared but Table 15.5 lends to a broad comparison. The entire open-pit tonnes for Vertikalny (green) numbers adds up, bar rounding, to the entire tonnes included in the Financial Model (Appendix C) without including any inventory from stockpiles. The (red) numbers in Table 15.5 above the NSR cut-off we get (258kt) effectively correlates with the larger optimization shell at 50g/t Ag COG in the MRE (Table 13.27), which would be expected with the larger pit shell used for the mineable tonnes.

Considering Vertikalny underground, the MRE represents a set of underground operating parameters applied to block grades below the open pit shell and classified accordingly as potentially economic. It does not include a design or development whereas the mineable tonnes does incorporate a stope optimiser to simulate stoping and considers development. The MRE uses a higher cut-off and break even reflecting the current operating costs and G&A. The mineable tonnes is based on a break-even for the stopes using the more optimistic operating costs.

In Table 15.6 attached splitting the tonnes into M & I + Inf, the indicated material at 300g/t cut-off grade roughly corresponds with the indicated for **undiluted** mineralisation NSR>\$124/t (256kt orange) which is a reasonable approximation to the MRE (236kt M&I shown in Table 13.28). The main difference is the mineable tonnes also includes development at zero cut-off (231kt), inferred material and planned loss and dilution – hence the higher tonnage, given rounding in calculations, approximating to 840kt.

WAI does not see any need to adjust in-pit or underground parameters for the MRE to reflect the more optimistic parameters as the original conditions supplied by SBR in November 2019 still best reflect the operating conditions of the mine and does not exclude material critical to the project assumptions. The schedule and combined design is conceptual and not based on reserves.

## 16.6 Open Pit Optimisation

### 16.6.1 Overview

WAI has carried out open pit optimisation for the Vertikalny and Mangazeisky North deposits using the Datamine NPV Scheduler v4 (NPVS) software package.

The pit optimisations were carried out on the resource block models generated for the two deposits and driven on the calculated block NSR values. Optimisations were driven on *Measured*, *Indicated* and *Inferred* resources.

NPVS utilises the Lerchs-Grossmann (LG) algorithm to produce a pit shell yielding the highest undiscounted profit; subject to a fixed set of selling prices (NSR values), mining costs, processing costs

and slope angle constraints. NPVS provides the ability to parametrise the commodity selling price (NSR values) and run successive applications of the LG algorithm to generate a sequence of nested pit shells; commonly known as LG phases.

## 16.6.2 Vertikalny Deposit

### 16.6.2.1 Optimisation Parameters

A breakdown of the costs and parameters used in the Vertikalny deposit pit optimisation are presented in Table 16.8.

<b>Table 16.8: Optimisation Input Parameters</b>			
<b>Parameter</b>	<b>Unit</b>	<b>Value</b>	<b>Source</b>
<b>Milling Rate</b>	ktpa	180	SBR – Planned rate
<b>Discount Rate</b>	%	8	WAI Estimate
<b>Mining Cost</b>	US\$/t	2.53	SBR Estimate
<b>Processing Cost</b>			
Oxides	US\$/t ore	50.00	SBR Estimate
Sulphides	US\$/t ore	46.97	SBR Estimate
<b>G&amp;A</b>	US\$/t ore	40.00	SBR Estimate
<b>Mining Recovery</b>	%	95%	Tetra Tech
<b>Mining Dilution</b>	%	30%	Tetra Tech
<b>Slope Angles</b>			
Hanging Wall	°	56	SRK
Footwall	°	48	SRK

WAI has not carried out an independent review of the optimisation parameters. All optimisation cost parameters were provided by SBR.

### 16.6.2.2 NSR Cut-Off Calculation

NPVS was used to calculate a marginal NSR cut-off using the parameters presented in the section above. The marginal NSR cut-off grade is the NSR value at which the revenue generated from a block is equal to the cost of processing it. The calculated cut-offs per rock type are as follows:

Oxide Material	= \$117.00/t
Sulphide Material	= \$113.06/t

NPVS uses the calculated marginal cut-offs to delineate ore and waste blocks within the block model. Waste blocks are assigned a net value equal to the cost of mining the block as waste, whereas ore blocks are assigned a net value equal to the revenues generated from the block, less the associated costs of production. The resulting 'net value' model is used by NPVS to determine the optimal mining envelopes; details of which are presented in the following sections.

### 16.6.2.3 Optimal Shell

A summary of the in-situ tonnages and grades contained within the selected optimal pit shell is provided in Table 16.9.

Parameter	Units	Value
<b>Oxide Material</b>	kt	205
<i>Ag Grade</i>	<i>g/t</i>	<i>973</i>
<b>Sulphide Material</b>	kt	158
<i>Ag Grade</i>	<i>g/t</i>	<i>1,040</i>
<i>Pb Grade</i>	%	2.31
<i>Zn Grade</i>	%	2.29
<b>Total Mineralised Tonnes (Oxide + Sulphide)</b>	kt	362
<b>Oxide Material (Below Cut-Off) (NSR&lt;117.0 US\$/t)</b>	Kt	36.8
<b>Sulphide Material (Below Cut-Off) (NSR&lt;113.06 US\$/t)</b>	kt	26.4
<b>Waste</b>	kt	8,300
<b>Strip</b>	tw:to	23.1

**Note:**

- All figures rounded to 3SF. Pb/Zn grades rounded to 2DP.
- Oxide material processed through oxide circuit; as such Pb/Zn are not recovered and are not reported.
- Tonnage and grade figures may not reconcile due to rounding.
- Mining dilution and recovery **not** applied.
- Figures effective as of 01.11.19.
- Strip ratio inclusive of below cut-off material:  

$$\text{Strip Ratio} = (\text{Waste} + \text{Oxide Material Below Cut-off} + \text{Sulphide Material Below Cut-off}) / \text{Total Mineralised Tonnes}$$

### 16.6.3 Mangazeisky North Deposit

#### 16.6.3.1 Optimisation Parameters

A breakdown of the costs and parameters used in the Mangazeisky North deposit pit optimisation are presented in Table 16.10.

Table 16.10: Optimisation Input Parameters			
Parameter	Unit	Value	Source
Milling Rate	ktpa	115	Current Rate
Discount Rate	%	8	WAI Estimate
Mining Cost	US\$/t	2.53	SBR
Processing Cost Sulphides	US\$/t ore	46.97	SBR
G&A	US\$/t ore	60.00	SBR
Mining Recovery	%	95%	Tetra Tech
Mining Dilution	%	30%	Tetra Tech
Slope Angles	°	45	WAI Estimate

**Note:**

- Only sulphide processing costs applied as no oxide material modelled in resource model.

WAI has not carried out an independent review of the optimisation parameters. All optimisation cost parameters were provided by SBR.

#### 16.6.3.2 NSR Cut-Off Calculation

The calculated NSR cut-off for the Mangazeisky North deposit is summarised below.

$$\text{Sulphide Material} = \$113.06/\text{t}$$

### 16.6.3.3 Optimal Shell

A summary of the in-situ tonnages and grades contained within the Mangazeisky North optimal shell is provided in Table 16.11.

Parameter	Units	Pit Shell 38
<b>Sulphide Material</b>	kt	311
<i>Ag Grade</i>	<i>g/t</i>	<i>775</i>
<i>Pb Grade</i>	<i>%</i>	<i>10.07</i>
<i>Zn Grade</i>	<i>%</i>	<i>0.98</i>
<b>Sulphide Material Below Cut-Off (NSR&lt;113.06 US\$/t)</b>	kt	40.0
<b>Waste</b>	kt	8,890
<b>Strip</b>	tw:to	28.7

**NOTE:**

- All figures rounded to 3SF. Pb/Zn grades rounded to 2DP.
- Tonnage and grade figures may not reconcile due to rounding.
- Mining dilution and recovery **not** applied.
- Strip ratio inclusive of below cut-off material:  

$$\text{Strip Ratio} = (\text{Waste} + \text{Sulphide Material Below Cut-off}) / \text{Total Mineralised Tonnes}.$$

## 16.7 Open Pit Design

### 16.7.1 Vertikalny Conceptual Pit Design

#### 16.7.1.1 Pit Design Parameters

A summary of the parameters used in the Vertikalny pit designs is presented in Table 16.12.

Parameter	Units	Value	Source
Bench Height	m	20	SBR
Bench Face Angle	°	70	SBR
Berm Width	m	11	SBR
Ramp Width (Single/Double)	m	12.5/17.016	SBR
Ramp Gradient	%	8	SBR
Min. Working Width Final Benches	m	16	SBR

#### 16.7.1.2 Pit Design

Two individual pits have been designed along the strike of the Vertikalny deposit; in-line with the selected optimal pit shell. The portion of the pit shell extracting material from the south-eastern extent of the mineralised zone intercepts a hillside. A conceptual cut & fill (CAF) road has been designed along the hillside to provide an initial indication of the access requirements to this area.

Plan, sectional and isometric views of the generated pit designs are presented in Figure 16.11 to Figure 16.13.

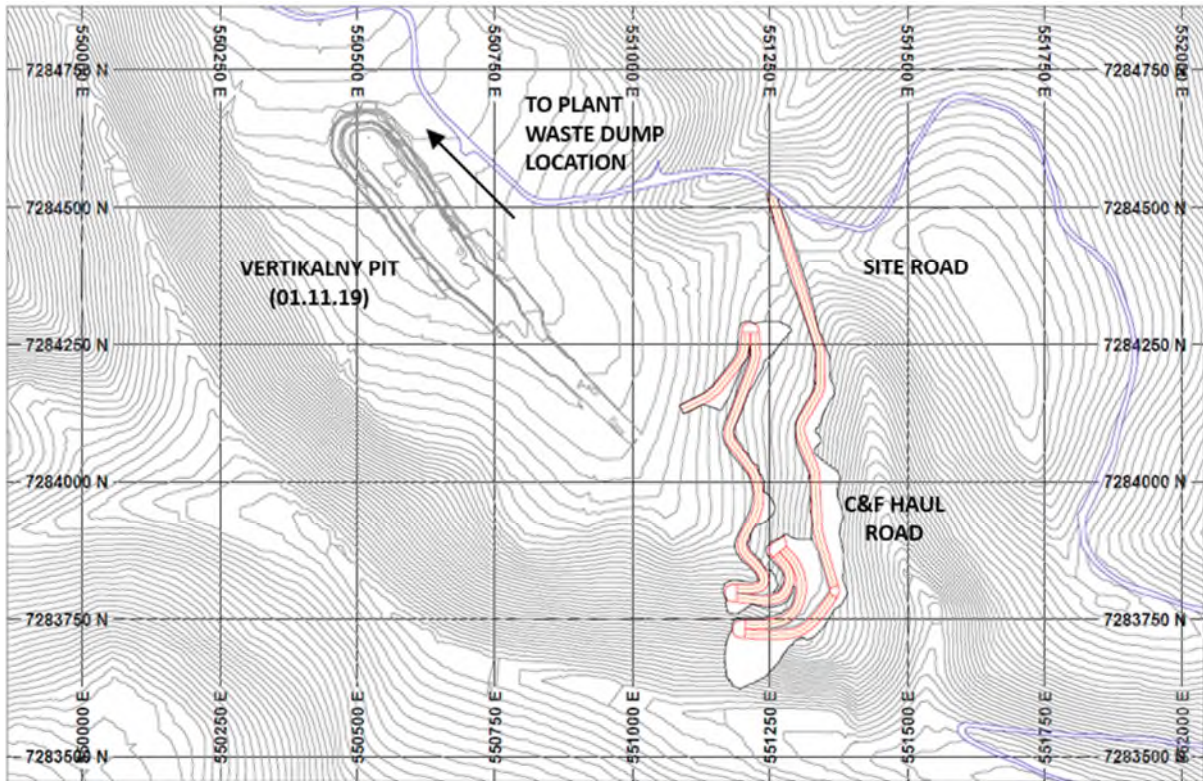
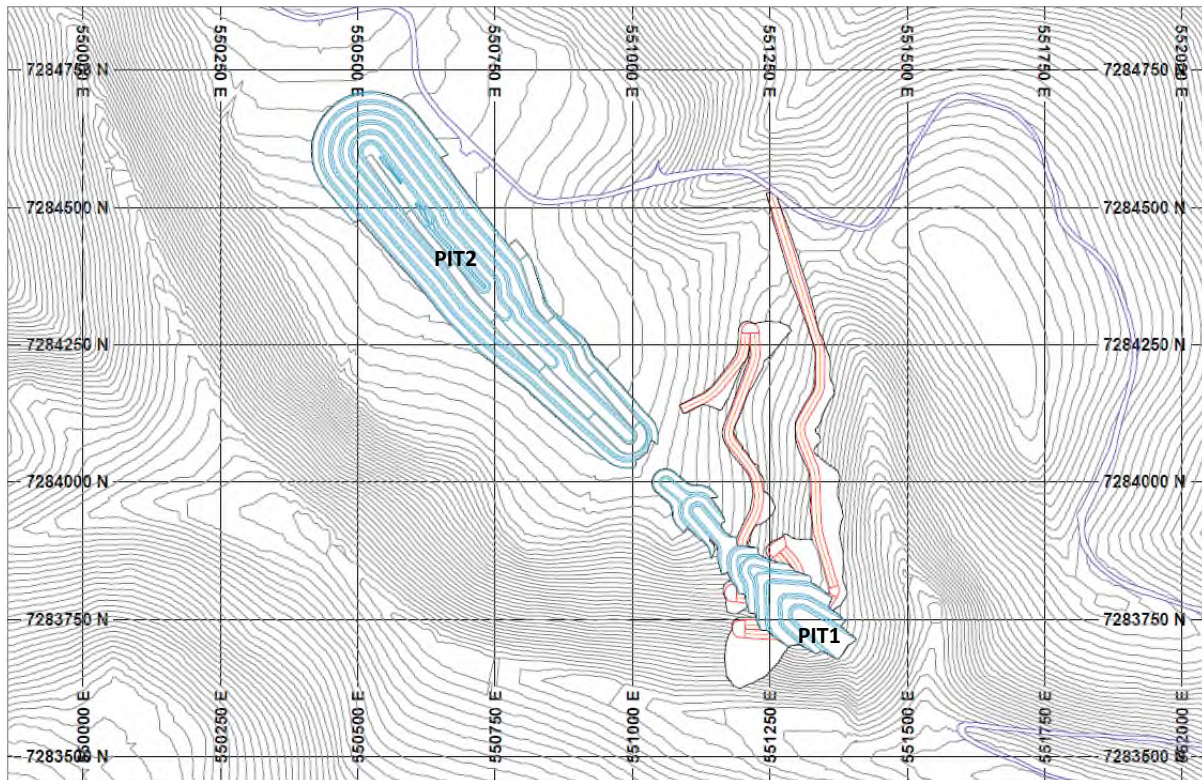
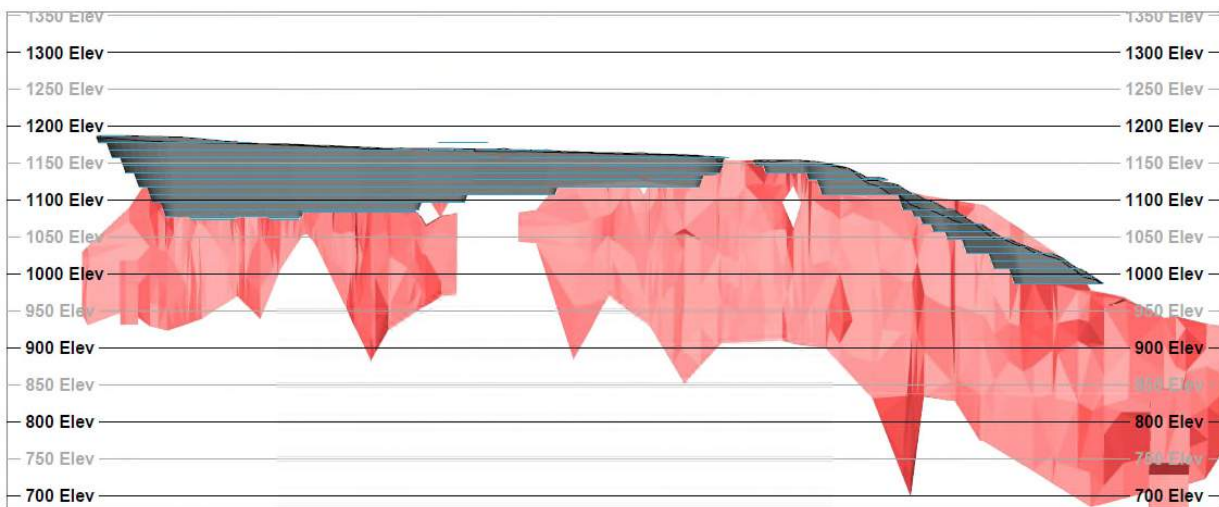


Figure 16.11: Vertikalny Cut & Fill Road



**Figure 16.12: Vertikalny Conceptual Pit Design**



**Figure 16.13: Vertikalny Conceptual Pit Design -Sectional View**

The volume of cut material required to prepare the CAF road is estimated at 169,000m<sup>3</sup>. CAF road designs are conceptual only and may not be representative of the final access requirements.

A summary of tonnages and grades contained within the conceptual pit designs is provided in Table 16.13.



Parameter	Units	Value
<b>Oxide Material</b>	kt	212
<i>Ag Grade</i>	<i>g/t</i>	800
<b>Sulphide Material</b>	kt	116
<i>Ag Grade</i>	<i>g/t</i>	846
<i>Pb Grade</i>	%	1.70
<i>Zn Grade</i>	%	1.66
<b>Total Mineralised Tonnes (Oxide + Sulphide)</b>	kt	329
<b>Oxide Material Below Cut-Off</b> <i>(NSR&lt;117.00 US\$/t)</i>	kt	45.0
<b>Sulphide Material Below Cut-Off</b> <i>(NSR&lt;113.06 US\$/t)</i>	kt	29.0
<b>Waste</b>	kt	11,000
<b>Strip</b>	tw:to	33.7

**Note:**

- All figures rounded to 3SF. Pb/Zn grades rounded to 2DP.
- Oxide material processed through oxide circuit; as such Pb/Zn are not recovered and are not reported.
- Volume, tonnage and grade figures may not reconcile due to rounding.
- Mining dilution (30%) and mining recovery (95%) applied.
- Strip ratio inclusive of below cut-off material:  

$$\text{Strip Ratio} = (\text{Waste} + \text{Oxide Material Below Cut-off} + \text{Sulphide Material Below Cut-off}) / \text{Total Mineralised Tonnes}$$
- Figures effective as of 01.11.19
- Figures not representative of Ore Reserves (in accordance with JORC 2012)

WAI has not prepared a waste dump design as part of this study. It is assumed that the current waste dump footprint may be extended to accommodate any additional waste material. Waste disposal strategies should be examined in greater detail in further engineering studies. The pit physicals are based on the topographic surface as of November 2019.

## 16.7.2 Mangazeisky Conceptual Pit Design

### 16.7.2.1 Pit Design Parameters

A summary of the parameters used in the Mangazeisky North pit design is provided in Table 16.14.

Parameter	Units	Value	Source
Bench Height	m	10	WAI Estimate
Bench Face Angle	°	70	WAI Estimate
Berm Width	m	6.4	WAI Estimate
Ramp Width	m	16	Tetra Tech
Min Ramp Width	m	10	Tetra Tech
Min. Working Width Final Benches	m	<10	Tetra Tech

### 16.7.2.2 Conceptual Pit Design

The Mangazeisky North deposit is situated some 6.5km NNW of the Vertikalny Pit. The pit shell is located on the brow of a hill approximately 130m above the valley floor. A conceptual cut & fill road was designed along the hillside to provide an indication of pit access requirements.

Plan, sectional and isometric views of the generate pit designs are presented in Figure 16.14 to Figure 16.16.

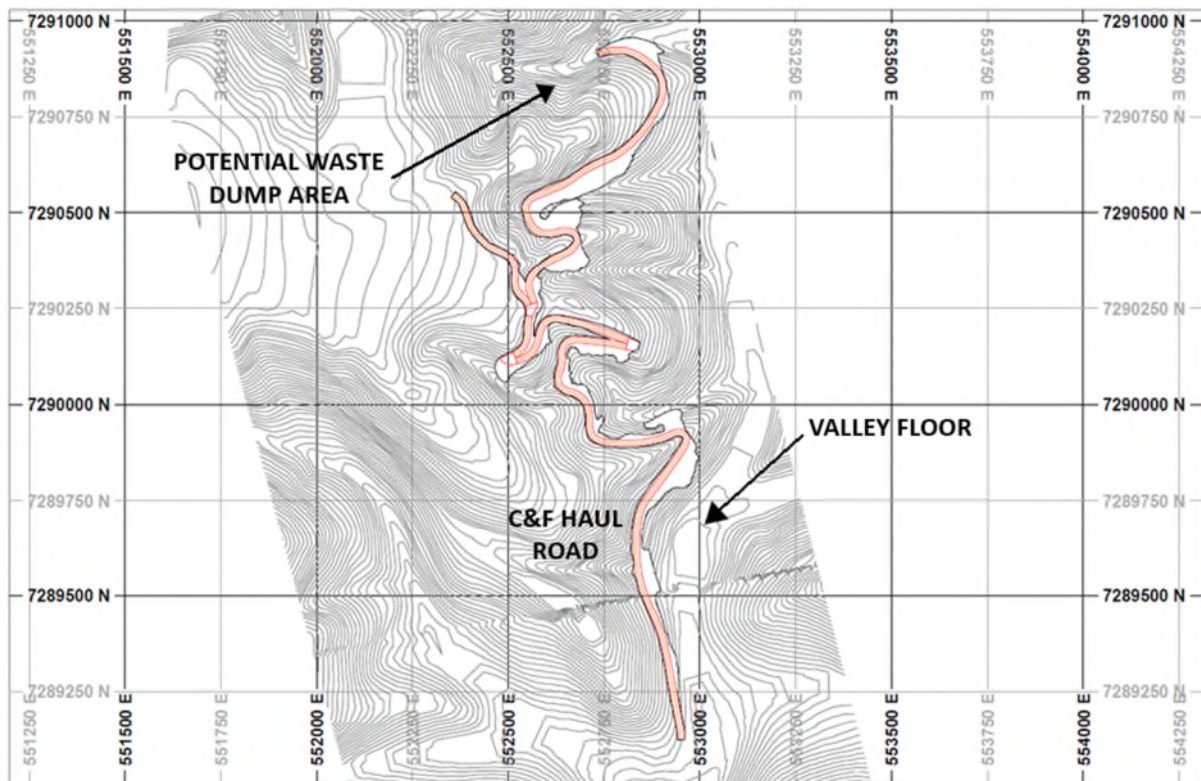
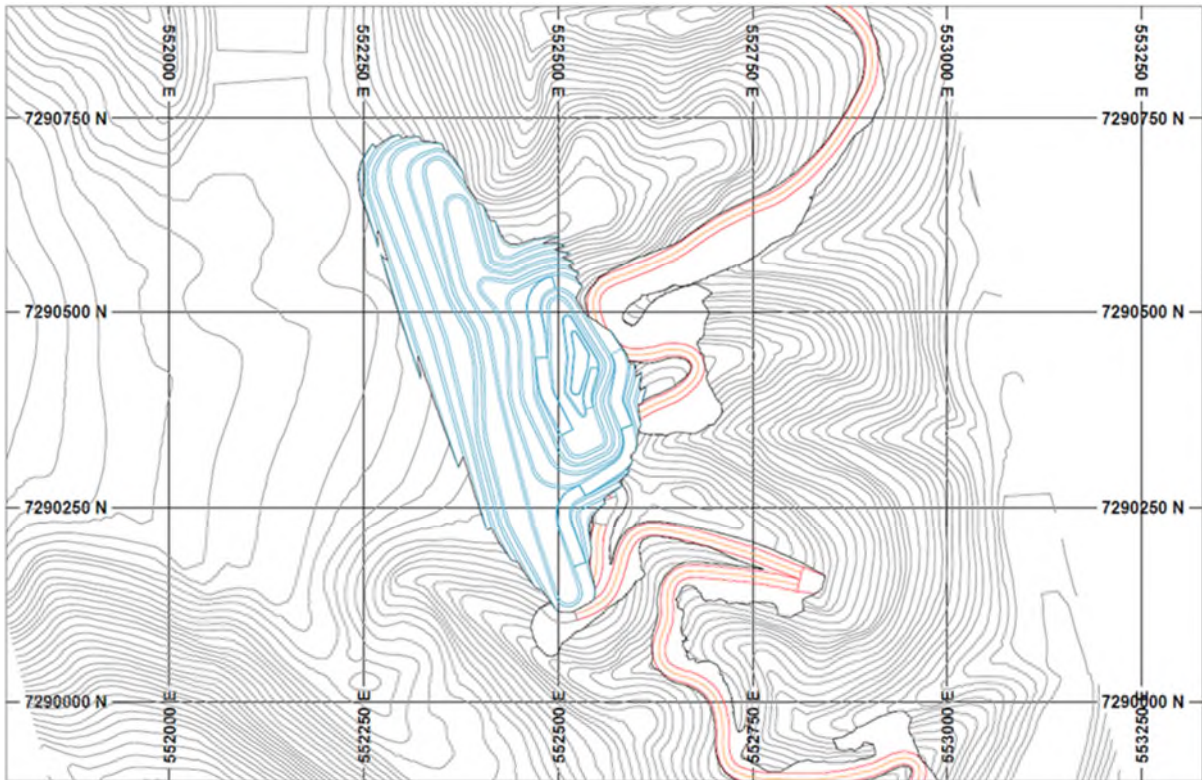
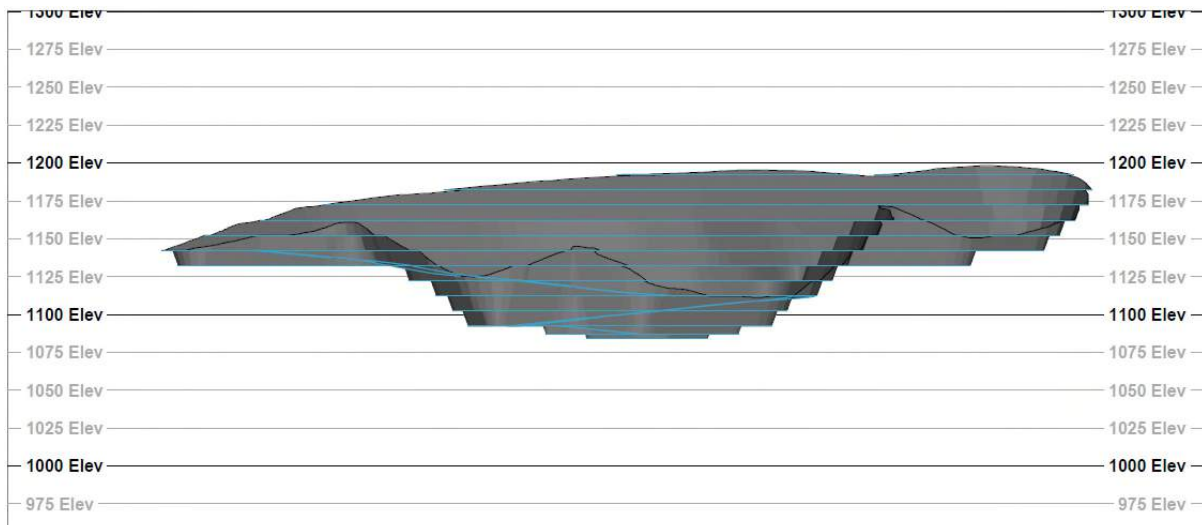


Figure 16.14: Mangazeisky Cut & Fill Road



**Figure 16.15: Mangazeisky North Conceptual Pit Design**



**Figure 16.16: Mangazeisky North Conceptual Pit Design – Section View**

The volume of cut material required to prepare the CAF road is estimated at 175,000m<sup>3</sup>. CAF road designs are conceptual only and may not be representative of the final access requirements.

A summary of tonnages and grades contained within the conceptual pit design is provided in Table 16.15.

**Table 16.15: Mangazeisky Conceptual Pit Design Physicals (Dilution & Recovery Applied)**

Parameter	Units	Value
<b>Sulphide Material</b>	kt	347
<i>Ag Grade</i>	<i>g/t</i>	570
<i>Pb Grade</i>	%	7.47
<i>Zn Grade</i>	%	0.82
<b>Sulphide Material Below Cut-Off</b> ( <i>NSR &lt; 113.06 US\$/t</i> )	kt	72.2
<b>Waste</b>	kt	8,540
<b>Strip</b>	tw:to	24.8

**Note:**

- All figures rounded to 3SF. Pb/Zn grades rounded to 2DP.
- Volume, tonnage and grade figures may not reconcile due to rounding.
- Mining dilution (30%) and mining recovery (95%) applied.
- Strip ratio inclusive of below cut-off material:  

$$\text{Strip Ratio} = (\text{Waste} + \text{Sulphide Material Below Cut-off}) / \text{Total Mineralised Tonnes}$$
- Figures not representative of Ore Reserves (in accordance with JORC 2012)

WAI has not prepared a waste dump design as part of this study. Waste disposal strategies should be evaluated in greater detail in further engineering studies.

## 16.8 Underground Mining

### 16.8.1 Underground Mining Method

WAI propose to maintain the mining methodology outlined by Tetra Tech; mechanised sub-level open stoping (SLOS). The method offers favourable results in safety, cost and dilution control as outlined by Tetra Tech. Stopes will be extracted in a retreat, top-down sequence, with adequate in-situ rock pillars left unmined for localised and regional stability.

### 16.8.2 NSR Cut-Off

The NSR of each potential mining block was evaluated against a break-even economic cut-off value. The economic cut-off considers the cost of mining, processing and the general and administrative costs.

Mining blocks with an average NSR value above the economic cut-off, that have defined access, and are not isolated (i.e. mining blocks that do not pay for the development of those blocks) are included in the mine design. Mining blocks that do not meet the criteria above are disregarded.

A summary of the parameters used in the calculation of the breakeven NSR cut-off is provided in Table 16.16

Parameters	Units	Value	Comment
Mining Cost	US\$/t <sub>ore</sub>	55.00	Tetra Tech - Calculated operating cost
Processing Cost	US\$/t <sub>ore</sub>	46.97	SBR
G&A	US\$/t <sub>ore</sub>	40.00	SBR
<b>NSR Cut-Off</b>	<b>US\$/t<sub>ore</sub></b>	<b>142.00</b>	

Only sulphide processing costs have been considered as most of the potential stope material will be situated within primary mineralisation.

### 16.8.3 Stope Optimisation

#### 16.8.3.1 Optimisation Parameters

Underground mineable tonnage estimates were prepared using the Vertikalny Resource block model as the basis for stope optimisation.

Stope shapes were defined using the Datamine Mineable Shape Optimiser (MSO) module. MSO generates a set of practical stope shapes around a geological block model in accordance with a supplied cut-off grade and a set of geometrical constraints. A summary of the input parameters used in stope optimisation is provided in Table 16.17.

Parameters	Units	Value	Comment
NSR Cut-Off	US\$/t <sub>ore</sub>	142.00	
Level Intervals	m	25	Tetra Tech
Stope Strike Length	m	10	Tetra Tech
Minimum Mining Width	m	1.3	Tetra Tech
Maximum Mining Width	m	4	Tetra Tech

#### 16.8.3.2 Optimisation Results

A summary of the in-situ stope tonnages and grades is provided in Table 16.18

Parameter	Units	Value
Mineralised Material	kt	655
Ag	g/t	569
Pb	%	2.64
Zn	%	2.09
NSR	US\$/t	236

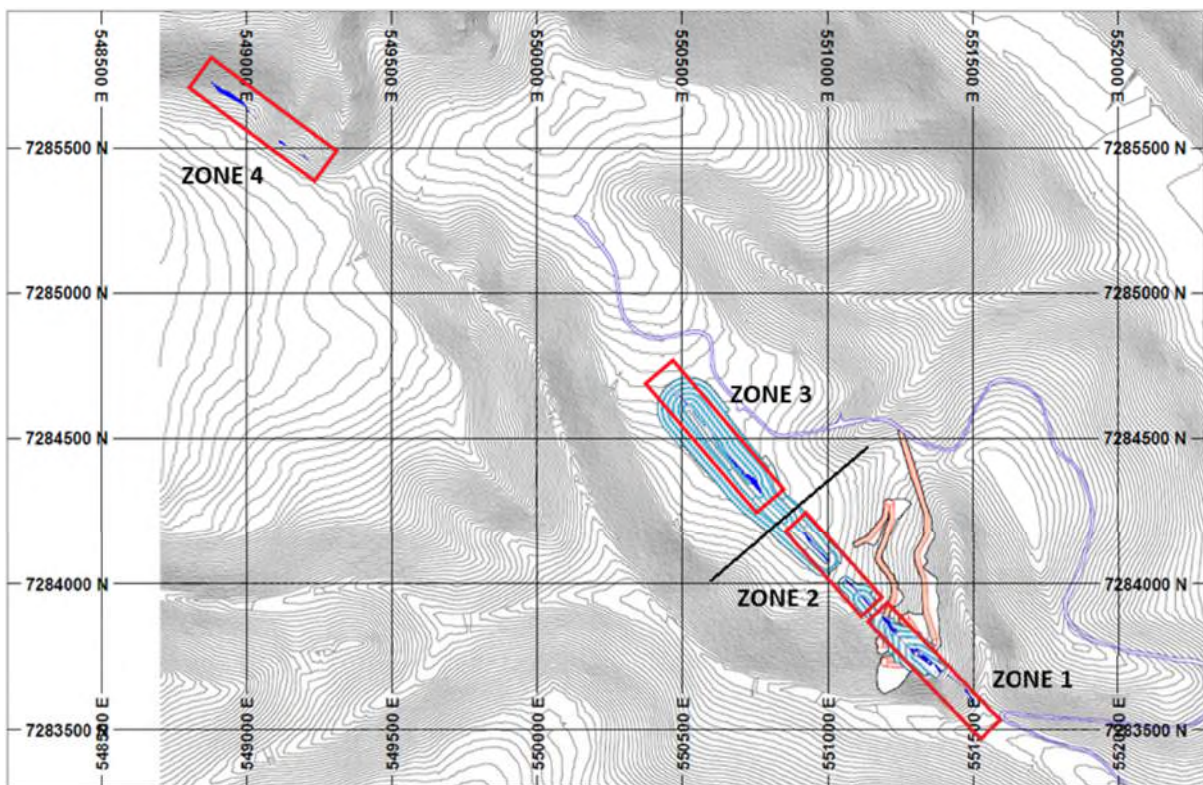
**Note:**

- Figures rounded to 3SF, Pb/Zn grades rounded to 2DP
- The generated stopes contain 92.5kt of waste material which would need to be mined (representative of planned dilution)
- Unplanned dilution and recovery factors (pillar losses, mining recovery etc.) have not been applied.

WAI notes that 2.0% of the stope mineralised tonnes are classified as oxide material. A summary of in-situ stope tonnage resource classification split is presented in Table 16.19

Parameter	Value
Measured	0%
Indicated	48%
Inferred	52%

The locations of the planned underground mining zones and sectional views of the generate stopes are presented in Figure 16.7 to Figure 16.18.



**Figure 16.17: Planned Underground Mining Zones**

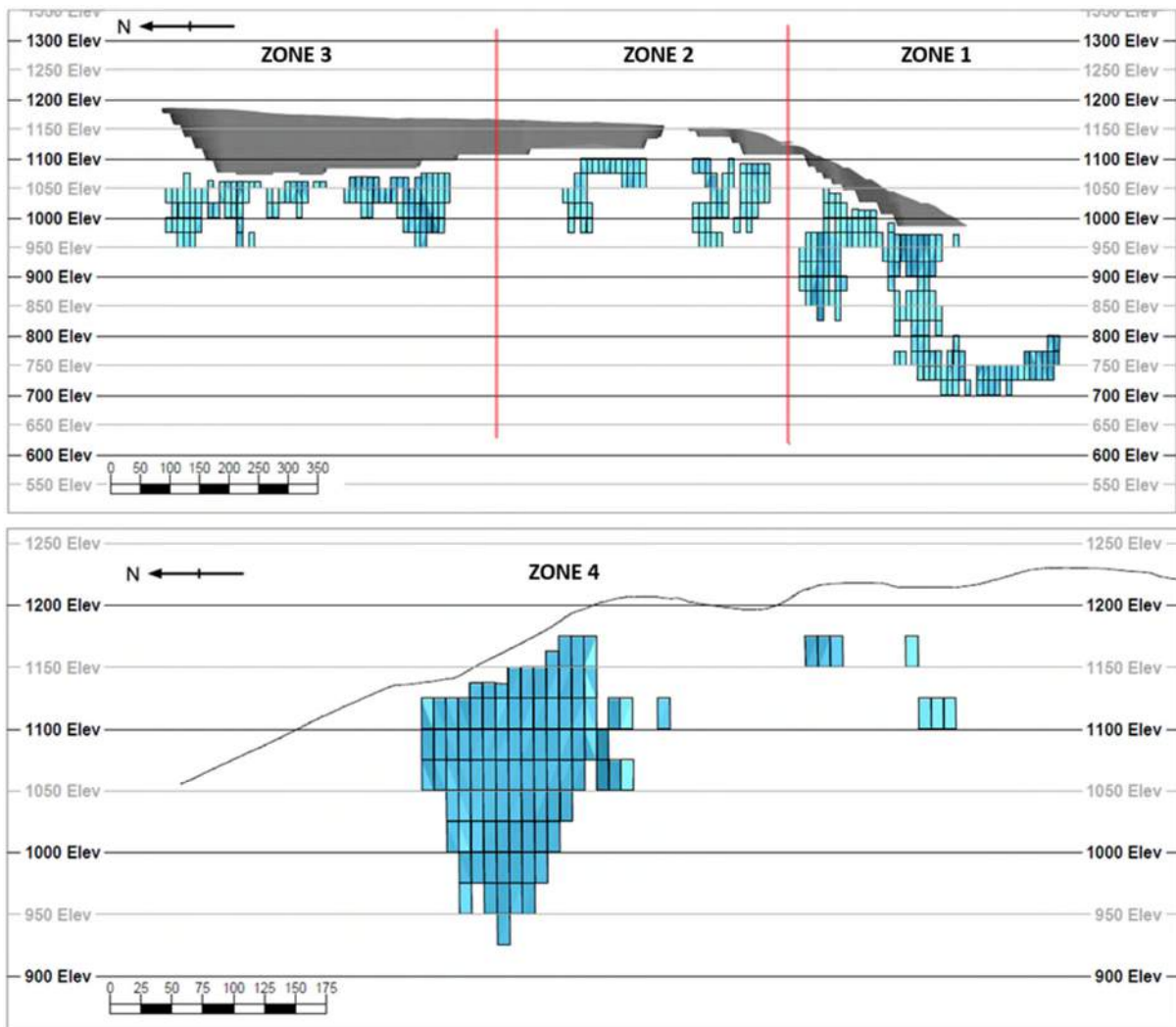


Figure 16.18: Vertikalny Stopes

## 16.8.4 Underground Mine Design

### 16.8.4.1 Design Parameters

A total of four underground mining zones were designed in line with the stope zones presented in Section 16.8.3.3.2 (Figure 15.17). The following excavation types were included in the underground development designs:

- Main decline (access);
- Level access drives (drives from the decline to access the ore drives);
- Ventilation drives (ventilation tunnels connecting the waste access crosscuts to the ventilation raises);
- Ventilation raises;
- Remuck bays (stockpile bays 7.5m long); and

- Ore drives (excavations developed along the strike of the mineralised vein to provide access for slot raise and stope drilling).

WAI has maintained the underground mine design parameters implemented within the Tetra Tech study. All mine development was positioned within the footwall of the deposit. The parameters used in underground mine design are summarised in Table 16.20 and Table 16.21,.

<b>Table 16.20: Underground Design Parameters</b>			
<b>Parameter</b>	<b>Units</b>	<b>Footwall</b>	<b>Source</b>
Level Spacing	m	25	Tetra Tech
Minimum Crown Pillar Depth	m	15	SRK
Decline Gradient	1:N	1:8	WAI Estimate
Decline Turn Radius	m	20	WAI Estimate

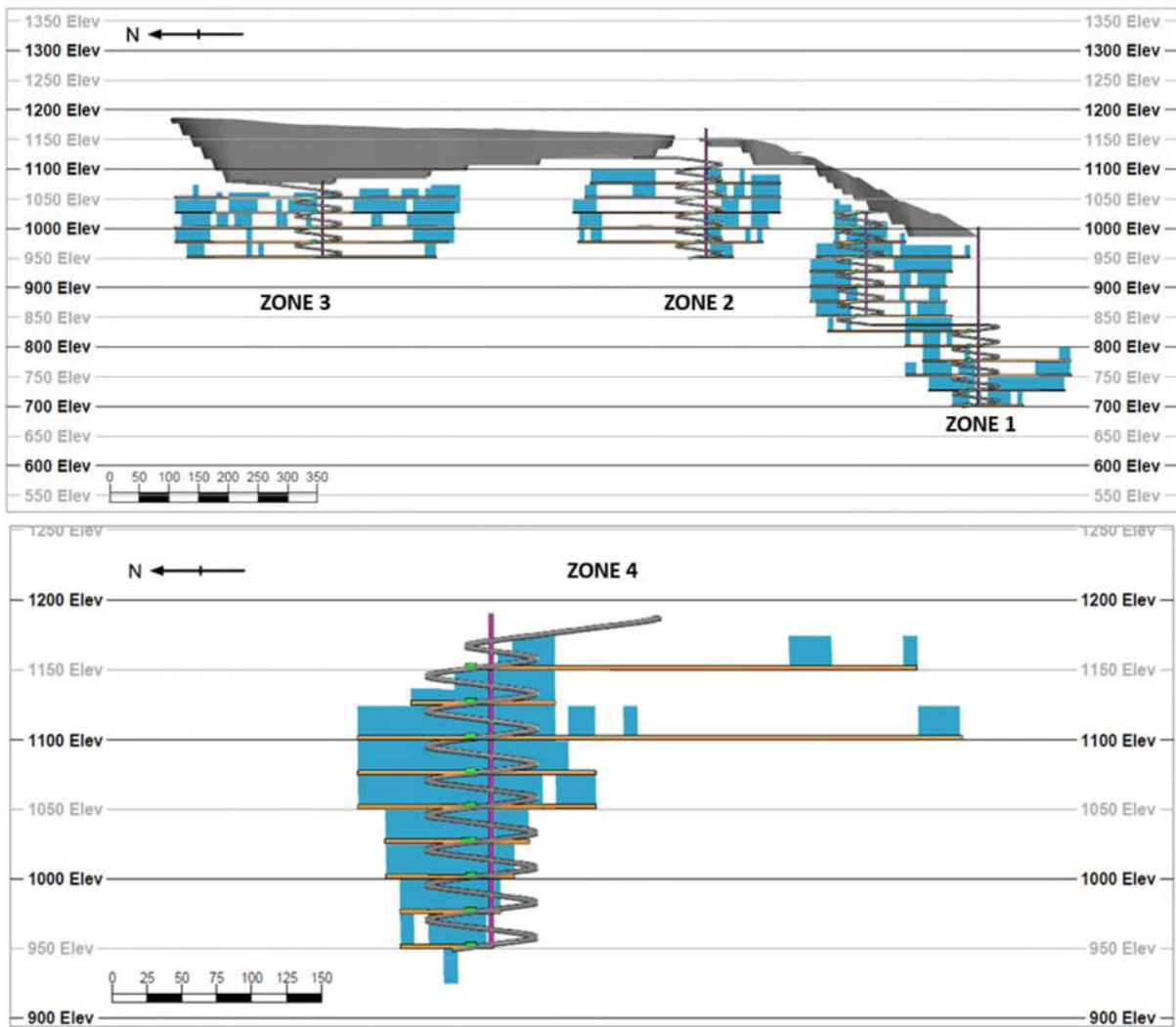
<b>Table 16.21: Development Dimensions</b>			
<b>Development Class</b>	<b>Dimensions</b>	<b>Area</b>	<b>Source</b>
	mW x mH	m <sup>2</sup>	
Decline	3.8 x 3.2 (Arch)	11.71	Tetra Tech
Ventilation & Access Drive	3.0 x 3.0 (Arch)	8.55	Tetra Tech
Remuck Bay	4.5 x 4.5 (Arch)	19.80	Tetra Tech
On Vein Drive	3.2 x 3.0 (Arch)	9.15	Tetra Tech
Ventilation Raise	3.0m (Diameter)	7.07	Tetra Tech

#### 16.8.4.2 Conceptual Underground Mine Designs

Sectional and isometric views of the generated underground mine designs are presented in Figure 16.19, Figure 16.20 and Figure 16.21.

.





**Figure 16.19: Vertikalny Conceptual Underground Mine Design – Sectional View**

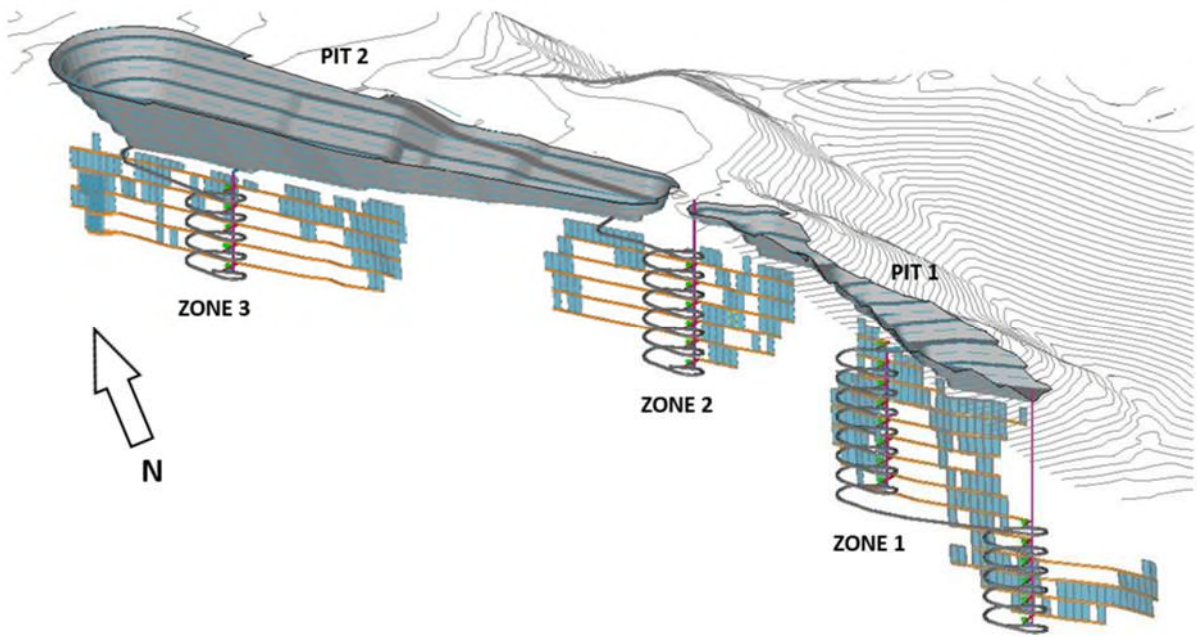


Figure 16.20: Vertikalny Underground Zone 1-3 Isometric View

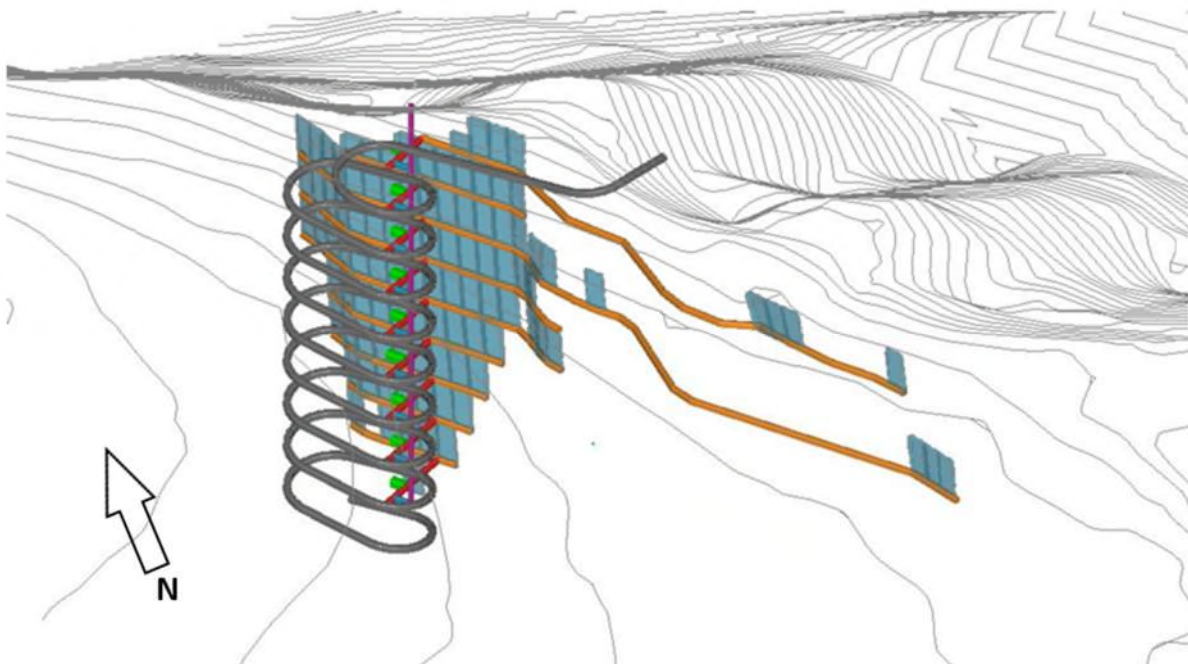


Figure 16.21: Vertikalny Underground Zone 4 Isometric View

A summary of the tonnages and grades contained within the conceptual underground mine designs is provided in Table 16.22.

Parameter	Units	Value
<b>Stope Mineralised Material</b>	kt	609
<i>Ag Grade</i>	<i>g/t</i>	462
<i>Pb Grade</i>	%	2.16
<i>Zn Grade</i>	%	1.68
<b>Development Mineralised Material (On-Vein Drives Only)</b>	kt	232
<i>Ag Grade</i>	<i>g/t</i>	263
<i>Pb Grade</i>	%	1.37
<i>Zn Grade</i>	%	1.26

**Note:**

- Unplanned Dilution of 10% and Mining Loss of 10% applied to **stope** mineralised material.
- Development mineralised tonnes depleted from stope tonnes.
- All figures rounded to 3SF. Pb/Zn grades rounded to 2DP
- Figures not representative of Ore Reserves (in accordance with JORC 2012)

## 16.9 Mine Production Scheduling and Equipment Requirements

Mine production scheduling was carried out using the Geovia MineSched mine scheduling software package. A combined open pit and underground production schedule was generated utilising the mine designs for both the Vertikalny and Mangazeisky North deposits. A scheduling block model was prepared in which the mineralised material was split by cut-off grade (i.e., above/below) and rock type (i.e., oxide/fresh).

### 16.9.1 Combined Production Schedule

The schedule was prepared on the premise that a flotation circuit will be implemented to process the sulphide feed following depletion of the oxides contained within the Vertikalny open pit. A flotation plant is anticipated to be available as of mid-2021. Any sulphide feed produced before this is assumed to be processed through the current leach circuit.

An ore sorter will be available on site as of Q2 2020. A summary of the ore sorting parameters is provided below:

- Mass Recovery = 66% (Source: SBR)
- Ag Recovery = 99% (Source: SBR)
- Pb Recovery = 99% (Source: SBR)
- Zn Recovery = 99% (Source: SBR)

SBR have indicated that due to the installation of the new ore sorter, below cut-off material will be incorporated into the plant feed. Consequently, WAI has incorporated this approach in subsequent scheduling.

The targeted processing plant throughput rates (post ore sorter) are summarised below:

1. Oxide: 115ktpa (Current plant throughput rate)
2. Sulphide: 180ktpa (SBR flotation plant capacity estimate)

Underground production is scheduled to coincide with the depletion of the open pits; thereby, maintaining a steady throughput of mineralised material to the plant. A steady state stope production rate of 340tpd has been applied.

Results of the production schedule are summarised in Table 16.23 to Table 16.28. WAI notes that scheduling has been carried out on a quarterly basis but has been reported annually.

Table 16.23: Vertikalny Open Pit Physicals										
Parameter	Units	2019	2020	2021	2022	2023	2024	2025	2026	Total
<b>Oxide (NSR&gt;=117 US\$/t)</b>	<b>kt</b>	<b>15.9</b>	<b>87.6</b>	<b>109</b>	-	-	-	-	-	<b>212</b>
<i>Ag</i>	<i>g/t</i>	716	789	821	-	-	-	-	-	<b>800</b>
<b>Oxide (NSR&lt;117 US\$/t)</b>	<b>kt</b>	<b>4.10</b>	<b>25.6</b>	<b>15.3</b>	-	-	-	-	-	<b>45.0</b>
<i>Ag</i>	<i>g/t</i>	92	100	114	-	-	-	-	-	<b>104</b>
<b>Sulphide (NSR&gt;=113.06 US\$/t)</b>	<b>Kt</b>	<b>3.45</b>	<b>47.2</b>	<b>65.7</b>	-	-	-	-	-	<b>116</b>
<i>Ag</i>	<i>g/t</i>	814	959	767	-	-	-	-	-	<b>846</b>
<i>Pb</i>	%	0.95	1.65	1.79	-	-	-	-	-	<b>1.70</b>
<i>Zn</i>		2.37	1.46	1.76	-	-	-	-	-	<b>1.66</b>
<b>Sulphide (NSR&lt;113.06 US\$/t)</b>	<b>kt</b>	<b>0.150</b>	<b>15.3</b>	<b>13.6</b>	-	-	-	-	-	<b>29.0</b>
<i>Ag</i>	<i>g/t</i>	136	147	114	-	-	-	-	-	<b>131</b>
<i>Pb</i>	%	0.32	0.81	1.19	-	-	-	-	-	<b>0.98</b>
<i>Zn</i>	%	0.34	1.04	1.72	-	-	-	-	-	<b>1.36</b>
<b>Total Mineralised Material</b>	<b>kt</b>	<b>23.6</b>	<b>176</b>	<b>204</b>	-	-	-	-	-	<b>403</b>
<b>Waste</b>	<b>Kt</b>	<b>383</b>	<b>5,530</b>	<b>5,080</b>	-	-	-	-	-	<b>11,000</b>

**Notes:**

- All figures rounded to 3SF. Pb/Zn grades rounded to 2DP.
- Tonnage and grade figures may not reconcile due to rounding.
- Mining **dilution (30%)** and mining **recovery (95%)** applied.
- Figures not representative of Ore Reserves (in accordance with JORC 2012)
- Figures effective as of 01.11.19

**Table 16.24: Mangazeisky North Open Pit Physicals**

Parameter	Units	2019	2020	2021	2022	2023	2024	2025	2026	Total
<b>Sulphide (NSR<math>\geq</math>113.06 US\$/t)</b>	<b>Kt</b>	-	-	<b>32.1</b>	<b>199</b>	<b>115</b>	-	-	-	<b>347</b>
<i>Ag</i>	g/t	-	-	507	554	617	-	-	-	570
<i>Pb</i>	%	-	-	4.84	6.35	10.16	-	-	-	7.47
<i>Zn</i>		-	-	0.08	0.40	1.75	-	-	-	0.82
<b>Sulphide (NSR&lt;113.06 US\$/t)</b>	<b>kt</b>	-	-	<b>5.78</b>	<b>44.6</b>	<b>21.8</b>	-	-	-	<b>72.2</b>
<i>Ag</i>	g/t	-	-	161	125	128	-	-	-	129
<i>Pb</i>	%	-	-	0.55	1.51	1.33	-	-	-	1.38
<i>Zn</i>	%	-	-	0.01	0.16	0.90	-	-	-	0.37
<b>Total Mineralised Material</b>	<b>kt</b>	-	-	<b>37.9</b>	<b>244</b>	<b>137</b>	-	-	-	<b>419</b>
<b>Waste</b>	<b>Kt</b>	-	-	<b>1,070</b>	<b>4,680</b>	<b>2,790</b>	-	-	-	<b>8,540</b>

**Notes:**

- All figures rounded to 3SF. Pb/Zn grades rounded to 2DP.
- Tonnage and grade figures may not reconcile due to rounding.
- Mining **dilution (30%)** and mining **recovery (95%)** applied.
- Figures not representative of Ore Reserves (in accordance with JORC 2012)

Table 16.25: Vertikalny UG Physicals										
Parameter	Units	2019	2020	2021	2022	2023	2024	2025	2026	Total
<b>Waste Development</b>	kt	-	-	-	55.4	81.4	92.8	54.7	-	284
<b>Vein Drive Mineralised Material</b>	kt	-	-	-	17.5	89.3	82.0	40.2	2.59	232
<i>Ag</i>	g/t	-	-	-	281	269	231	306	239	263
<i>Pb</i>	%	-	-	-	1.34	1.17	1.35	1.88	1.13	1.37
<i>Zn</i>	%	-	-	-	2.35	1.53	0.84	1.07	0.72	1.26
<b>Stope Mineralised Material</b>	kt	-	-	-	-	43.3	172	233	160	609
<i>Ag</i>	g/t	-	-	-	-	457	452	466	468	462
<i>Pb</i>	%	-	-	-	-	2.39	1.65	1.51	3.60	2.16
<i>Zn</i>	%	-	-	-	-	2.95	2.50	1.35	0.92	1.68
<b>Total Mineralised Material</b>	kt	-	-	-	17.5	133	254	273	163	840
<i>Ag</i>	%	-	-	-	281	331	381	442	465	407
<i>Pb</i>	%	-	-	-	1.34	1.57	1.56	1.57	3.56	1.95
<i>Zn</i>	%	-	-	-	2.35	1.99	1.97	1.31	0.92	1.56

**Notes:**

- All figures rounded to 3SF. Pb/Zn grades rounded to 2DP.
- Tonnage and grade figures may not reconcile due to rounding.
- Mining **dilution (10%)** and mining **recovery (90%)** applied to stope tonnes.
- On-vein drive mineralised material depleted from stope tonnes.
- Figures not representative of Ore Reserves (in accordance with JORC 2012)

Table 16.26: Stockpile Balance (Closing Balance)										
Parameter	Units	2019	2020	2021	2022	2023	2024	2025	2026	
<b>Oxide Stockpile*</b>	kt	45.2	-	-	-	-	-	-	-	
<b>Sulphide Stockpile</b>	kt	3.60	13.8	52.0	41.6	38.9	19.2	19.8	-	

\* Out-of-balance, sub grade material

**Table 16.27: Ore Feed (Through Sorter from Q2 2020)**

Parameter	Units	2019	2020	2021	2022	2023	2024	2025	2026	Total
<b>LEACH PLANT (CURRENT)</b>										
<b>Oxide Feed</b>	<b>kt</b>	<b>20.0</b>	<b>113</b>	<b>124</b>	-	-	-	-	-	<b>257</b>
<i>Ag</i>	<i>g/t</i>	588	633	734	-	-	-	-	-	<b>678</b>
<b>Sulphide Feed</b>	<b>kt</b>	-	<b>52.3</b>	<b>31.9</b>	-	-	-	-	-	<b>84.2</b>
<i>Ag</i>	<i>%</i>	-	799	514	-	-	-	-	-	<b>691</b>
<b>Sulphide + Oxide Feed</b>	<b>kt</b>	<b>20.0</b>	<b>165</b>	<b>156</b>	-	-	-	-	-	<b>342</b>
<b>FLOTATION PLANT</b>										
<b>Sulphide Feed</b>	<b>Kt</b>	-	-	<b>47.2</b>	<b>272</b>	<b>272</b>	<b>274</b>	<b>272</b>	<b>183</b>	<b>1,320</b>
<i>Ag</i>	<i>g/t</i>	-	-	587	507	460	379	439	448	<b>452</b>
<i>Pb</i>	<i>%</i>	-	-	2.99	4.89	5.61	1.53	1.53	3.39	<b>3.37</b>
<i>Zn</i>	<i>%</i>	-	-	0.99	0.53	1.77	2.02	1.30	0.93	<b>1.33</b>

**Notes:**

- All figures rounded to 3SF. Pb/Zn grades rounded to 2DP.
- Dilution and recovery applied.



Table 16.28: Process Plant Feed										
Parameter	Units	2019	2020	2021	2022	2023	2024	2025	2026	Total
<b>LEACH PLANT (CURRENT)</b>										
<b>Oxide Feed</b>	<b>kt</b>	<b>20.0</b>	<b>84.8</b>	<b>82.0</b>	-	-	-	-	-	<b>187</b>
<i>Ag</i>	<i>g/t</i>	588	838	1,100	-	-	-	-	-	<b>927</b>
<b>Sulphide Feed</b>	<b>kt</b>	-	<b>34.5</b>	<b>21.1</b>	-	-	-	-	-	<b>55.6</b>
<i>Ag</i>	<i>g/t</i>	-	1,200	770	-	-	-	-	-	<b>1,040</b>
<b>Sulphide + Oxide Feed</b>	<b>kt</b>	<b>20.0</b>	<b>119</b>	<b>103</b>	-	-	-	-	-	<b>242</b>
<b>Sulphide in Blend</b>	<b>%</b>	<b>0%</b>	<b>29%</b>	<b>20%</b>	-	-	-	-	-	<b>23%</b>
<b>FLOTATION PLANT-</b>										
<b>Sulphide Feed</b>	<b>kt</b>	-	-	<b>31.1</b>	<b>179</b>	<b>180</b>	<b>181</b>	<b>180</b>	<b>121</b>	<b>872</b>
<i>Ag</i>	<i>g/t</i>	-	-	881	761	690	568	659	673	<b>677</b>
<i>Pb</i>	<i>%</i>	-	-	4.48	7.33	8.42	2.29	2.30	5.09	<b>5.06</b>
<i>Zn</i>	<i>%</i>	-	-	1.49	0.80	2.66	3.03	1.96	1.39	<b>1.99</b>

**Notes:**

- All figures rounded to 3SF. Pb/Zn grades rounded to 2DP.
- Dilution and recovery applied.

### 16.9.2 Development Profile

Horizontal and vertical development rates of 140m/mo (Tetra Tech estimate), and 1.5m/d (WAI estimate), were applied in scheduling, respectively. The development advance rates were used in MineSched to generate the development schedule. Development was scheduled sufficiently in advance to maintain steady state stope production. A summary of the development meterage by development type is provided in Table 16.29.

Development	Unit	2019	2020	2021	2022	2023	2024	2025	2026	TOTAL
Access Decline	m	-	-	-	1,487	2,192	2,343	1,389	-	7,411
Level Access Drive	m	-	-	-	193	328	395	293	-	1,208
On-Vein Drive	m	-	-	-	622	3,193	2,985	1,395	97	8,292
Remuck Bays	m	-	-	-	36	55	74	44	-	209
Vent Connection	m	-	-	-	69	75	79	51	-	273
Ventilation Raise	m	-	-	-	175	261	450	175	-	1,061
<b>TOTAL</b>	<b>m</b>	-	-	-	2,582	6,104	6,326	3,347	97	18,454

### 16.9.3 Open Pit Equipment Requirements

Mine equipment requirements were estimated to achieve the open pit production schedule presented in Table 16.30. Equipment requirement estimates for drilling, loading and hauling were calculated from first principles analysis. Key considerations made in estimation include:

- Utilisation of similar specification equipment to that currently available on site;
- Application of the current blast design parameters;
- Estimates of the annual haulage distances to the waste rock dump (WRD) and run-of-mine (ROM) pad; and,
- Application of suitable productivity/utilisation factors and working hours.

The ancillary equipment requirements were estimated based on previous experience of similar projects and approximate working hours required. A summary of the estimated major fleet requirements is provided in Table 16.30.

TYPE	MODEL	QTY
Excavator	CAT 336 DL (Ore)	1
	CAT 349 DL (Waste)	2
Haul Trucks	SCANIA G440	8
Production Drills	Sunward SWDE-120 (Or equiv.)	3
Wheel Loader	CAT 950GC	2
Motor Grader	CAT14M (Or equiv.)	1
Tracked Dozer	D9R	1
Fuel Tank	8,000L	2
Water Tank	6,000L	1
Lube/Shop Truck	-	1

All mining equipment currently deployed on site is owned and operated by SBR. A summary of the existing major mining equipment is provided in Table 16.31.

TYPE	MODEL	QTY
Excavator	CAT 336 DL (Ore)	1
	CAT 349 DL (Waste)	1
Haul Trucks	SCANIA G440	8
Tracked Dozer	CAT D9R	2
Production Drills	Sunward SWDE-120	1
	URB-2A2 (URAL 4320 Chassis)	1
Wheel Loader	CAT 950GC	2
Motor Grader	SEM-922	1
Fuel Tanker	8,000L	1
Water Tanker	6,000L	1

Comparison of Table 16.30 and Table 16.31 indicates that the following additional items of equipment will be required:

- 1x** CAT349 (Waste rock excavator)
- 1x** Production Drill (Atlas Copco ROCL or equivalent)
- 1x** 8,000L Fuel Tanker
- 1x** Auxiliary Lube/Shop truck

These additional items will be required as of 2020 of the production schedule, indicating an effective working life of four years before the cessation of open pit production in 2023. WAI has treated the equipment as leased over this period in order to save on the capital cost requirements of purchasing new equipment. It is assumed Scania trucks will be replaced near-end of operational life and retained for spares/cover for downtime/maintenance. Operating costs for these additional items include a mark-up factor of 25% to account for leasing.

#### 16.9.4 Underground Equipment Requirements

Mine equipment requirements were estimated to achieve the underground production schedule presented in Table 16.32. In addition to the mobile equipment, fixed infrastructure crucial to the operation of the underground workings were also considered..

<b>Table 16.32: Underground Equipment Requirements</b>	
<b>TYPE</b>	<b>QTY</b>
<b>Mobile Equipment</b>	
Development Jumbo – Single Boom	4
Production Drill	2
Load Haul Dump – 1.5m <sup>3</sup>	4
Underground Haul Truck – 20t	4
Raise Bore	1
Explosives Truck	1
Small Motor Grader	1
Fuel & Lube Truck	1
Water Truck (Dust suppression)	1
Underground 4x4	6
Scissor Lift	1
<b>Fixed Infrastructure</b>	
Primary Fan	4
Secondary Fans & Starters	16
Compressors	4
Main Pump	4
Face Pump	21
Jumbo Boxes	21

WAI notes that raise boring equipment was treated as leased in this study due to the high purchase price, life of the operation and anticipated workload. Operating costs include a mark-up factor of 50% to account for leasing.

Ventilation and fixed infrastructure requirements were not calculated in this study. Provision was made for these items based on data from similar projects and the number of underground mining zones in operation at single point in time. Detailed ventilation and infrastructural studies should be carried out in further studies.

#### 16.10 Risks

The key mining risks associated with the Mangazeisky Silver project are summarised in the points below:

- The derived ‘mineable tonnage’ estimates for the Vertikalny and Mangazeisky North deposits are not representative of Ore Reserves. Sufficiently detailed modifying factors were not applied, nor was economic viability demonstrated to a suitable degree of confidence.

- The Mangazeisky North deposit is comprised of Inferred Resources only. Further infill drilling is required to upgrade geological and metallurgical confidence. This is essential to progress the deposit to a more advanced stage of design and planning. The Mangazeisky North deposit provides an essential source of sulphide feed and provides the necessary time to develop a potential underground mine at the Vertikalny deposit following depletion of the Vertikalny open pit.
- WAI is unaware of the presence of any detailed geotechnical data and analysis for the Mangazeisky North deposit. The conceptual pit design was based on a set of design criteria derived from analogous projects. Additional geotechnical data and analysis is required to define a set of site-specific design criteria to mitigate the risks associated with geotechnically sub-optimal pit designs.
- WAI's production schedule indicates that a shortage of oxide feed from the Vertikalny open pit will occur between Q3 2020 and Q1 2021. During this period, the oxide feed shortage will be substituted with sulphide material. The main risks associated with processing sulphide material through the current processing plant include significantly higher processing costs and reduced metal recoveries.
- The Vertikalny conceptual open pit design includes a significant amount of waste material due to the implementation of SBR's pit design criteria which utilise wide benches, shallow haul roads and minimum pit bottom width requirements. A significant amount of waste development is required in order to maintain steady production (combined oxide and sulphide). SBR have indicated that additional equipment is being brought to site to address the increased waste mining volumes. Should mining productivity or equipment capacity be lower than required, ore production may be adversely impacted and exacerbate the oxide feed gap.
- Low-grade stockpiled (stockpile no.5) oxide material may offer an opportunity to address the oxide feed gap indicated in the production schedule. The material composition and metallurgical characteristics of this stockpile are unknown and require further sampling and testing before being considered a viable source of feed to bridge the oxide production gap. Initial scheduling results indicate that the oxide deficit could potentially be reduced by half when incorporating the low-grade stockpile into the production schedule (assuming stockpile material suitable for plant feed).
- Construction of a flotation plant is anticipated for completion by mid-2021. The generated production schedule assumes that production will seamlessly transition between the current (oxide) plant and new flotation plant in Q4 2021. It is assumed that the flotation plant will require no ramp-up period and be able to accept sulphide material at the stated capacity of 180ktpa (as indicated by SBR). Should a ramp-up period be required, actual metal production may be lower than that indicated in the production schedule; therefore, adversely impacting project economics.
- Further geotechnical data and analysis is required to refine the underground geotechnical design criteria as derived for the Vertikalny deposit by SRK Consulting in 2014. Particular attention should be given to the identification of any potential large-scale structural features that may pose a risk to underground excavations.

- Underground development dimensions used in the Vertikalny underground mine design were based on the design parameters outlined in the Tetra Tech study (dated 21-08-17). The Tetra Tech study assumed a steady state underground production rate of 110ktpa. The production rate target used by WAI in underground scheduling was 272ktpa. This is due to the higher capacity of the new flotation plant (180ktpa) and the presence of an upstream ore sorter which rejects approximately 33% of ROM plant feed. Underground development dimensions must be re-evaluated to accommodate the potentially larger equipment required to achieve the higher production rates.
- Mining capital and operating cost estimates are based on a Preliminary Economic Assessment (PEA) level of confidence ( $\pm 45\%$ ). The study offers a valuable view in determining the merits of pursuing further engineering studies but should not be the sole reference for the purposes of economic decision making. Enhanced engineering costs estimates should be prepared as part of a more detailed study aligned with the preparation of an Ore Reserve estimate.

## **17 RECOVERY METHODS**

### **17.1 Introduction**

Wardell Armstrong International was requested to undertake a Strategic Review of current operations at SBR. The main issue from a processing perspective is the amount of primary sulphides that require processing and the potential options for doing this. The process plant as currently configured was designed to operate on oxides only. This review mainly references actual SBR operating data as provided by SBR and the Tetra Tech (TT) NI 43-101 Feasibility Study report, dated 9<sup>th</sup> June 2016. The main oxide ore zones currently being mined and processed are from the Vertikalny Central and Northwest zones. These were drilled most recently in 2013/2014 and current mining is by open pit. Additional ore zones drilled in 2015 but not yet mined include Mangazeisky North and South zones, which are predominantly primary sulphide ore. It appears that these zones have not yet been tested, with primary ore testing restricted to the deeper parts of the Vertikalny Central zone.

EMC Mining developed the detailed design documentation for the plant based on the conceptual circuit originally developed by Tetra Tech and this documentation has been generally reviewed. In addition, Benitex developed the design documentation for the recently constructed Merrill Crowe plant. A 2019 site visit report by Benitex on the status of the overall plant and the Merrill Crowe plant in particular was also reviewed.

### **17.2 Process Design**

#### **17.2.1 Oxide Ore**

The process design is based upon the original Tetra Tech design in the feasibility study but with some modifications introduced by SBR. EMC Mining developed the final process design and detailed design documentation for construction.

The original Tetra Tech design was based on the processing of oxide ore only, but with recommendations to modify the plant for processing sulphide ore. The plant was designed for a throughput of 110,000 tonnes per annum (tpa) and a plant availability of 91% for an operating throughput rate of 15tph. Design silver head grade was 772g/t Ag. First production of silver was achieved in April 2018.

Comminution is achieved using conventional two-stage crushing with a jaw and cone crusher and milling is achieved in a single ball mill equipped with a 500-kW motor. The grind size required is 80% passing 75 microns.

A gravity circuit was incorporated in the original design using a Knelson concentrator with regrinding and intensive cyanide leaching of the concentrate. However, the gravity circuit was not subsequently installed by SBR.

The grinding circuit incorporated two-stage hydrocyclones (classification and dewatering cyclones) but the dewatering cyclone was replaced with a dedicated pre-leach thickener, to achieve a nominal 50% solids pulp density required for leaching.

The original leach circuit required six tanks for a design residence time of 72 hours. However, with the exclusion of the gravity circuit and the testwork indicating the subsequent slow leach kinetics, an additional two leach tanks were installed by SBR to provide the increased design residence time of 96 hours.

The original design dewatered the final leach tailings slurry in a hydrocyclone with the overflow clarified in a high-rate clarifier (lamellar thickener) to produce a suitable solution for the direct electrowinning process. The clarifier and hydrocyclone underflows were then filtered in plate and frame filter presses. The filtrate solution was recycled to the plant as process water and the filtered solids disposed in a dedicated Dry Stack Tailings Facility.

This circuit was subsequently modified by removing the dewatering cyclone and clarifier and filtering the leach tailings directly in the filter presses, but now using two stages of filter presses to obtain solution suitable for direct electrowinning.

The direct electrowinning process uses patented emew<sup>®</sup> cell technology to recover the silver from solution, with the resulting silver precipitate shipped directly to a refinery (or can be smelted on-site).

The primary stage, consisting of 140 emew<sup>®</sup> powder cells, each 200 mm in diameter, reduces the silver solution from approximately 800ppm to 50ppm silver. The secondary stage, consisting of 80 emew<sup>®</sup> polishing cells, each 200mm in diameter, reduces the solution to below 10ppm silver prior to discharge. The entire direct electrowinning plant is supplied as a modular turnkey package plant by Electrometals. The barren solution is returned to the process water tank. The design should incorporate a 1% bleed of solution to avoid a build-up of base metals, such as zinc, in the solution. It is not known if this was incorporated into the final design.

Figure 17.1 shows the current schematic flowsheet for the plant including the changes as outlined above.



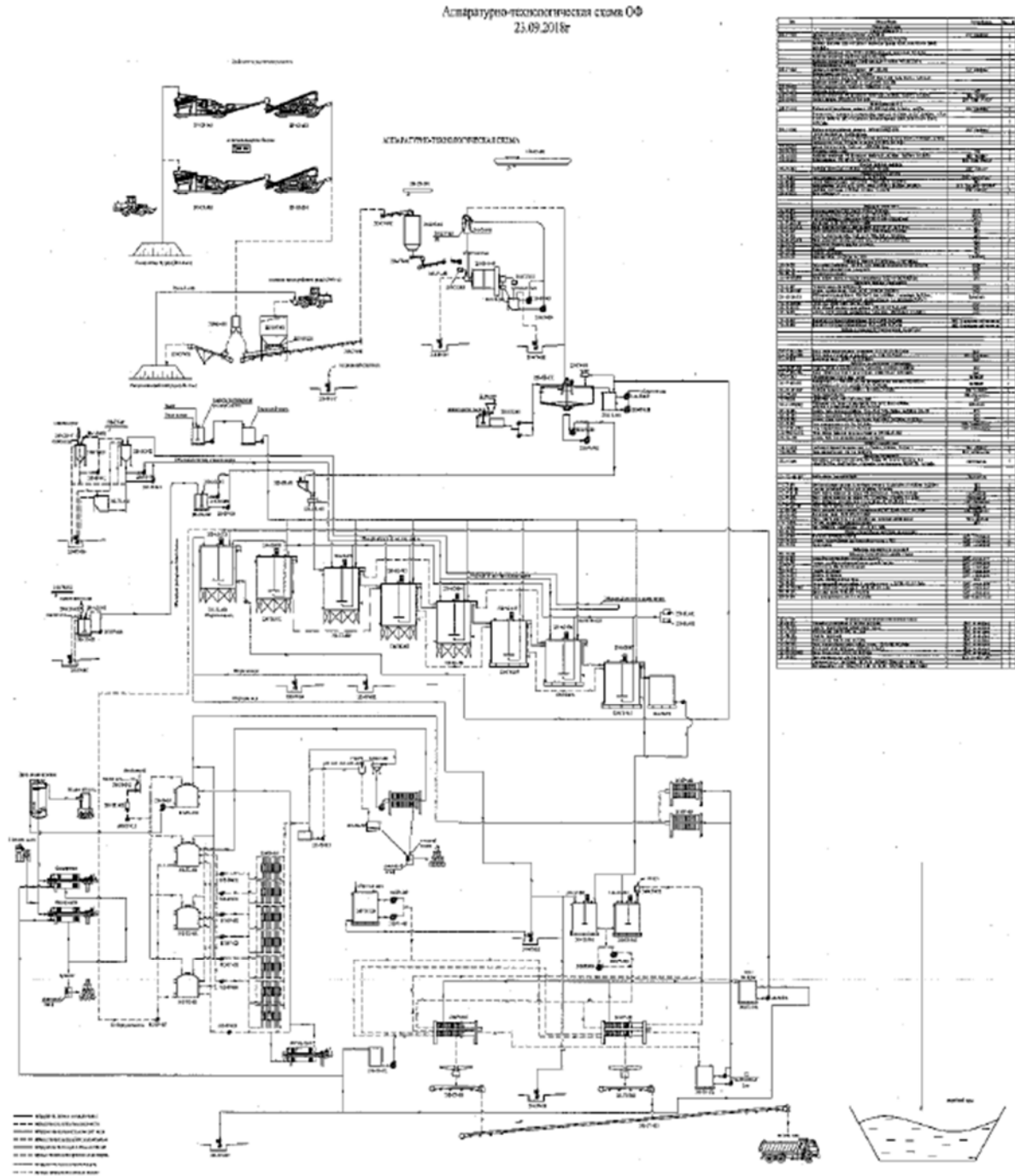


Figure 17.1: Schematic Flowsheet for Oxide Ore

### 17.2.1.1 *Current Problems & New Merrill Crowe Circuit*

A significant issue with SBR was the operation and performance of the direct electrowinning process. Issues include corrosion due to the chloride content in solution and excessive levels of base metals, in particular zinc. In fact, a new Merrill Crowe circuit was installed by Benitex in April 2019 (not shown in the flowsheet above). A representative from Benitex also conducted a site visit in April 2019 and commented that, at that time, there were issues with non-delivery and/or poor performance of some of the equipment and incorrect installation of some of the pipework. Some of these issues, including training of personnel, were rectified during the site visit, with others remaining to be completed. It was also recommended that cyanide solution be added after the deaeration tower to control the copper content in solution.

SBR report that the Merrill Crowe circuit is operating well and recovering 98-99% of the silver in solution. The circuit is flexible and operates either in parallel with the direct electrowinning circuit or in series by treating the electrowinning barren solution. It is the intention that the Merrill Crowe circuit will eventually operate directly as a replacement for the direct electrowinning circuit. The resulting silver-rich powder has approximately 70% silver content and is refined off-site, although it is recommended that silver bullion be produced on-site.

Other issues mentioned in the Benitex report include the following:

- Lack of instrumentation and automatic control in the milling circuit;
- Incorrect water distribution around the whole plant;
- Pre-leach thickener acting as a bottleneck, lack of instrumentation and control;
- Inefficient slurry mixing in the agitated leach tanks resulting in short-circuiting, and elevated temperatures attributed to oxidation of sulphides;
- Low silver recovery compared to design and the conclusion that up to 20% of the ore was primary sulphide ore;
- Low activity of received lime (55.8%);
- Manual dosing of lime from ring main system results in inefficient dosing;
- Incorrect cyanide make-up procedures and inefficient manual dosing;
- Insufficient water washing (time and volume) of the filtered solids resulting in 19.1% silver recovery loss in the solids reporting to tailings.

The main issues to be noted from the above observations are the high silver recovery loss of 19.1% estimated from insufficient washing of the filter cake, higher cyanide and lime consumptions from inefficient preparation and dosing and the inclusion of primary sulphide ore with the oxides that lowers recovery and increases reagent consumptions. Some of these issues were reportedly addressed during or soon after the Benitex site visit.

### **17.2.2 Primary Ore**

The proposed process design for treating primary sulphide ore includes a new flotation circuit for the production of separate lead and zinc concentrates. The lead flotation middlings are cyanide leached as per the current flowsheet to produce a silver-rich powder for transport to the refinery. The design allows for increased throughput to 180,000 tpa with harder ore and therefore includes additional crushing and milling capacity in the form of a second identical primary and crushing circuit and ball mill.

The schematic flowsheet is shown in Figure 17.2.

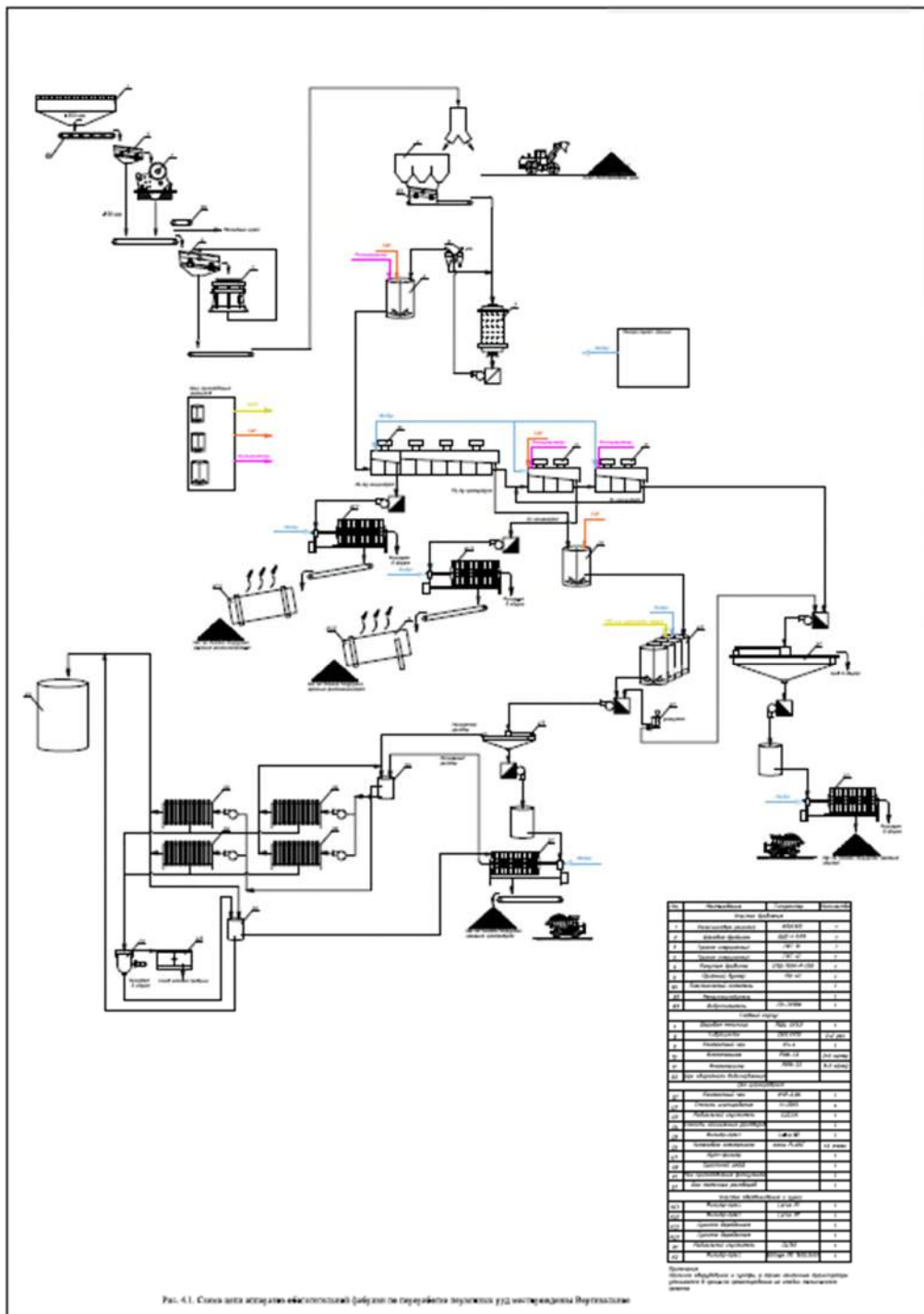


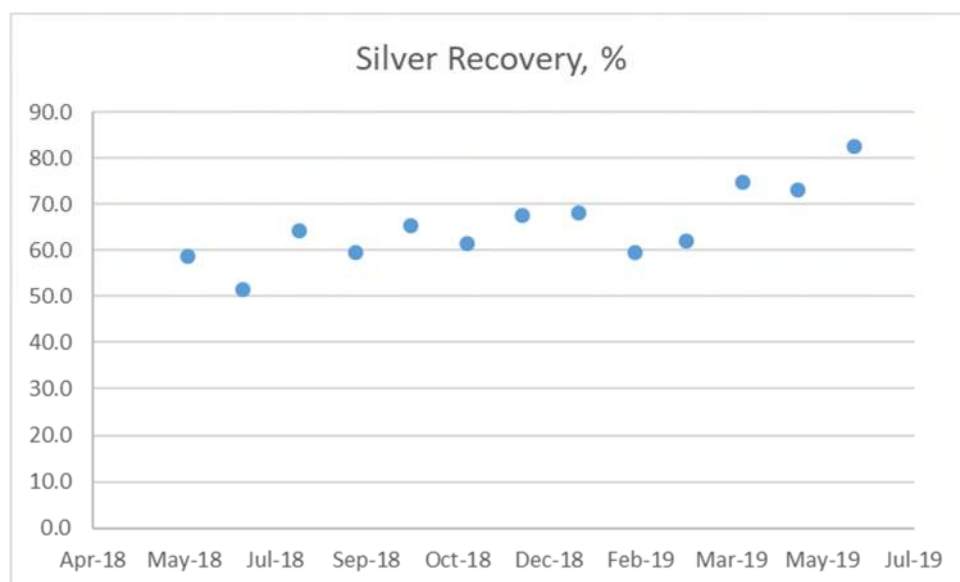
Figure 17.2: Schematic Process Flowsheet for Primary Sulphide Ore

### 17.3 Operating Performance

The mine achieved first silver production on oxide ore from open pit operations in April 2018. SBR has provided operating and cost data up to and including July 2019 for when this report was initially prepared.

For July 2019 YTD, SBR processed 55,184t at an average head grade of 672g/t Ag. Subsequently, in an update to this report and according to the SBR website, for the nine-month period to September 2019, 71,769t were processed at an average grade of 670g/t Ag for a silver recovery of 70.5%. Pro-rata, this is equivalent to approximately 96,000tpa, slightly less than the design of 110,000tpa.

Figure 17.3 plots the final silver recovery (allowing for refinery adjustments) since operations commenced, from the original production data supplied by SBR to July 2019.



**Figure 17.3: Final Silver Recovery**

Allowing for initial commissioning, it can be seen that silver recoveries remained generally in the range of 50 – 70% until April 2019, when recoveries sharply improved, approaching the design recovery of 85%. This coincided with a decrease in silver head grade to an average of 485g/t Ag for April – June 2019, as normally lower head grades will give lower recoveries and vice-versa. It is believed that, following the Benitex site visit and remedial measures to improve the washing of the tailings filter cake, where significant silver losses were occurring, this resulted in the improvement in silver recovery. Further measures to improve recovery included the addition of the Merrill Crowe circuit to re-process the barren solution from the direct electrowinning circuit.

It is believed that inclusion of primary sulphide ore in the plant feed blend has significantly contributed to the lower-than-design recoveries. SBR indicated that approximately 5-15% of the ore may be primary sulphide ore, although this is likely to be higher, and the reported cyanide concentration of 5,000 ppm (compared to the design for oxides of 2,000 ppm) also reflects this.

The design operating cost for oxide ore from the Tetra Tech feasibility study is **US\$47.9/t**. Power is the main contributor at \$23.4/t, followed by reagents at \$14.0/t, labour at \$8.3/t and maintenance at \$2.2/t. However, May 2019 YTD actual process costs are reported by SBR to be approximately **\$74.9/t**, with the reagents cost at approximately \$28/t, i.e. double the design. Some of the increase in unit costs can also be attributed to the lower actual throughput compared to design.

The main reagents consumed are cyanide, lime and steel balls and the design consumption rates are 4.6kg/t, 0.7kg/t and 0.7kg/t respectively. Actual June 2019 YTD consumptions are 5.9 kg/t, 23.9kg/t and 0.99kg/t respectively. The cyanide and steel ball consumptions show moderate increases compared to design, most likely a reflection of the sulphide ore content. The lime consumption, however, is significantly higher than design and it appears that the design value of 0.7 kg/t is incorrect based on the latest testwork.

Reviewing an SGS testwork report from 2014, lime consumptions in the bottle roll tests conducted varied from approximately 20 – 30kg/t. Even allowing for typical actual field consumptions to be 2-3 times lower than the testwork results, the design figure of 0.7kg/t is clearly too low. Design lime consumption should be approximately 15kg/t maximum, so actual consumption is still higher than this value. This is probably a reflection of the low as-delivered lime activity and inefficient dosing, as outlined in the Benitex report.

Sales and refinery costs are reported as approximately \$3.2/t for May 2019 YTD.

## **17.4 Ore Sorting**

Testwork has been conducted on the use of ore sorting to provide an upgraded feed to the flotation plant and to reject a low-grade tailings stream, allowing the mining of an increased throughput of 270ktpa to provide 180ktpa as feed for the new flotation plant.

### **17.4.1 Testwork**

A summary of the testwork results has been provided by SBR. The testwork was conducted by GeoTestService (GST) on two samples, a low-grade oxide sample (GTS1) and a current production sample (GTS2). Although no sorter testwork has been performed on primary sulphide ore, SBR reports that they expect results to be very similar due to the similar mineralogy. However, this does present a small risk that performance with primary ore may not be the same as for the oxide ore tested.

Testwork was conducted on three different size fractions, -100+60mm, -60+30mm and -30+15mm. The -15mm, at 28.8% of the feed mass, is too fine for ore sorting and will be fed direct to the flotation plant. The results from testing each of the three size fractions were broadly similar and, in summary, combining the results, the average stage sorter mass recovery to the “accepts” fraction was 22.8% and therefore 45% of the total ROM feed (including the -15mm fraction) will report to the flotation plant.

The average Ag, Pb and Zn recoveries to the flotation plant feed were 99%, 99% and 69.7% respectively. A significant upgrade in head assay also results, the Ag assay increasing from 690g/t to 1,518g/t, the Pb assay from 1.06% to 2.25% and the Zn assay from 1.61% to 2.48%. This should result in better flotation recoveries.

### 17.4.2 Processing Schedule

The latest mining schedule is shown below in Figure 17.4.

5. ORE SORTER FEED										
<b>CURRENT PLANT</b>										
Oxide	t	20,039	113,151	124,243	-	-	-	-	-	257,434
Ag	g/t	588	633	734	-	-	-	-	-	678
Sulphide	t	0.03	52,253	31,947	-	-	-	-	-	84,200
Ag	g/t	786	799	514	-	-	-	-	-	691
Oxide + Sulphide	t	20,039	165,405	156,190	-	-	-	-	-	341,634
<b>FLOTATION PLANT</b>										
Sulphide	t	-	-	47,152	271,817	272,394	273,860	272,493	182,754	1,320,470
Ag	g/t	-	-	587	507	460	379	439	448	452
Pb	%	-	-	2.99	4.89	5.61	1.53	1.53	3.39	3.37
Zn	%	-	-	0.99	0.53	1.77	2.02	1.30	0.93	1.33
6. PROCESS PLANT FEED										
Mass Recovery			0.66	0.66	0.66	0.66	0.66	0.66	0.66	0.66
Ag Recovery			0.99	0.99	0.99	0.99	0.99	0.99	0.99	0.99
Pb Recovery			0.99	0.99	0.99	0.99	0.99	0.99	0.99	0.99
Zn Recovery			0.99	0.99	0.99	0.99	0.99	0.99	0.99	0.99
<b>CURRENT PLANT</b>										
Oxide	t	20,039	84,844	82,001	-	-	-	-	-	186,884
Ag	g/t	588	838	1,101	-	-	-	-	-	927
Sulphide	t	0	34,487	21,085	-	-	-	-	-	55,572
Ag	g/t	786	1,199	770	-	-	-	-	-	1,036
Oxide+Sulphide	t	20,039	119,331	103,085	-	-	-	-	-	242,456
% Sulphide in Blend		-	29%	20%	0%	0%	0%	0%	0%	23%
<b>FLOTATION PLANT</b>										
Sulphide		-	-	31,121	179,399	179,780	180,747	179,845	120,618	871,510
Ag		-	-	881	761	690	568	659	673	677
Pb		-	-	4.48	7.33	8.42	2.29	2.30	5.09	5.06
Zn		-	-	1.49	0.80	2.66	3.03	1.96	1.39	1.99

Figure 17.4: Mining Schedule

The schedule indicates that ore sorting will be applied for the whole of 2020. However, SBR report that the sorter is expected to be commissioned towards the end of April 2020 (equipment is on site and installation has started). Sulphide ore will continue to be processed through the current plant in 2020 and most of 2021, until the new flotation plant is commissioned, reported by SBR to be expected in June 2021.

The tonnes processed through the current plant after ore sorting in 2020 and 2021 of 119kt and 103kt respectively should be achievable with continued optimisation, as SBR report that a throughput of 10,000tpd is now considered normal since further de-bottlenecking was completed in September 2019 (the plant design for oxides is 110ktpa, although harder sulphide ore is now in the blend (29% and 21% respectively for 2020 and 2021). However, there is still a risk that this throughput may not be achieved depending on the hardness and actual blend of sulphide ore. In addition, 31kt of sulphide ore is due to be processed through the new flotation plant in 2021.

From 2022 onwards, the ore feed is 100% sulphide ore through the new flotation plant, maintaining capacity at 180ktpa. At this rate, approximately 270ktpa of ROM feed is scheduled to be fed to the primary crusher. After primary crushing, the product is screened to remove the -15mm fraction (28.8%) that reports direct to the flotation plant. The remaining 71.2% reports to the ore sorter. Based on the original testwork, the tailings stream from the sorter is rejected (77.2% of sorter feed) with the accepts fraction (22.8%) reporting to the flotation plant after secondary crushing to -15mm. Using the

testwork value of 45% total mass split of ROM ore to flotation plant feed, this would calculate to a flotation plant feed of approximately 122ktpa.

However, it should be noted that, in the schedule above, the mass split of ROM ore to the flotation plant has been increased from 45% to 66%. The higher mass split results in a flotation plant throughput of approximately 180ktpa, as per design, with the stage sorter mass recovery increasing from 22.8% to 52.1% (192ktpa). Approximately 92ktpa of waste will be rejected in the sorter and 100ktpa report, after secondary crushing, with the -15mm fraction (78ktpa) after primary crushing, as flotation plant feed.

In addition, the Zn recovery has been increased from the 69.7% achieved in the testwork to 99%, matching that for the Ag and Pb. The higher mass split to the flotation plant, i.e. less rejects, is conservative and implies higher metal recovery and, as the Ag and Pb recovery is already very high, the Zn recovery has been increased as stated. This is not unreasonable, although with no further testwork planned, there is a risk that actual Zn recoveries may be lower. The Ag and Pb recoveries seem very high but appear to be corroborated by the testwork results. The higher mass split also results in a reduced upgrade of the head assays compared to the testwork results.

### **17.4.3 Design and Construction**

SBR propose to commission the new ore sorter by end-April 2020.

As opposed to the three size fractions tested, SBR plan to treat just two size fractions through the single ore sorter on a batch-basis, with different sorter programming and feed conveyor belt speed for each fraction. The two size fractions are -100mm+40mm and -40mm+15mm.

After primary crushing, the product is screened to remove the -15mm material that reports as flotation plant feed. The +15mm material is then screened into the two size fractions. These will be separately batch processed through the single ore sorter, adjusting the conveyor speed and sorter programming for each fraction.

According to the testwork results, the indicated ore sorter throughputs for the different size fractions tested were 18tph for the -30mm+15mm fraction, 31tph for the -60mm+30mm fraction and 63tph for the -100mm+60mm fraction. Using conservative estimates for the two size fractions to be sorted and with the estimated ore sorter throughput of 192ktpa (24tph @ 91% availability or approximately 12tph for each size fraction), then this is well within the capacity of the ore sorter unit, allowing plenty of time for maintenance.

One concern is that SBR report only one loader (FEL) will be utilised for feeding the primary crusher, feeding the ore sorter and rehandling the sorter accepts and rejects stockpiles. The accepts stockpile, along with the -15mm stockpile from screening the primary crusher product, must also be transported to the plant. The rejects stockpile must also be transported to a waste stockpile. One loader is unlikely to be sufficient for this purpose without significant risk to production and so it is strongly recommended that a second FEL should be purchased.



The installed capital cost for the ore sorter and associated infrastructure is estimated by SBR at \$2 million and the additional operating cost as \$2.25/t of ore sorter feed. This is considered reasonable.

## 17.5 Conclusions

After producing first silver production in April 2018, silver recoveries have improved from approximately 55% in 2018 to 70% for September 2019 YTD, although still short of the design for oxide ore of 85%. The improvement in 2019 is likely mainly due to better washing of the leach tailings solids filter cake, where Benitex reported that up to 19% of the silver was previously being lost due to poor washing. There is also a significant impact on recovery and costs from primary ore being included in the feed blend, reportedly 5-15% according to SBR, but likely higher than this. Higher cyanide concentrations of 5,000ppm are therefore being utilised, compared to the design of 2,000ppm.

Therefore, WAI recommends that the design silver recovery of 85% for oxide ore is still appropriate to be used for pit optimisation studies. A recovery of 29% should be applied to primary ore processed through the current plant without the circuit changes recommended in the feasibility study.

Apart from the lower recovery, the additional impact of any primary ore in the oxide feed through the current plant will be higher operating costs, with the cost of \$123.7/t used in the financial model for primary ore. The oxide operating cost used is \$72.9/t, significantly higher than the design of \$47.9/t, and reflects the inclusion of sulphide ore in the feed blend and actual current operating costs. Overall process unit costs are also higher due to the lower throughput compared to design.

Lime consumption is significantly higher than design, although this appears to be due to an incorrect design figure of 0.7kg/t used in the feasibility study, compared to the testwork data of 20-30kg/t. Further issues contributing to the actual lime consumption of 23.9kg/t are low activity and inefficient dosing.

For the proposed processing of primary sulphide ore, a new flotation circuit is required for the production of separate lead and zinc concentrates, with cyanide leaching of the lead flotation middlings as per the current circuit configuration. Most of the existing circuit can be utilised with the addition of the new flotation circuit and extra crushing and milling capacity for the proposed higher throughput of 180,000tpa, compared to the current design for oxide ore of 110,000tpa. The new plant is scheduled to be commissioned in June 2021.

The capital cost provided by SBR of approximately \$17.3M is considered reasonable for an approximate 500tpd brand new plant, although this reduces to approximately \$9.2M if the existing oxide circuit equipment is used and the additional equipment retrofitted, mainly the new flotation circuit and additional crushing and grinding capacity. SBR has assumed in their schedule that most of the new equipment can be constructed alongside the existing plant with minimal time required for the final tie-in.

The process operating cost for the new plant treating primary ore has been estimated by SBR as US\$47.1/t and is considered reasonable for use in the pit optimisation studies.

The recoveries used for primary ore in the pit optimisation studies are based on the ESTAGEo testwork results, with silver, lead and zinc recoveries of 85.4%, 65.9% and 82.2% respectively.

The zinc concentrate at 42.4% Zn is saleable based on typical western smelter contracts, but the lead concentrate at only 17.1% Pb is very low grade, but high in silver value at 10,215g/t Ag. This is more likely to be saleable to an Asian smelter. The NSR terms for both concentrates have been provided by SBR for use in the pit optimisation studies (84% and 45% respectively for the lead and zinc concentrates respectively).

Contract quotations should be sourced from interested smelters and a full elemental analysis conducted to determine the effect of all the potential deleterious elements, as not all appear to have been analysed.

It should be noted that the testwork on primary ore appears to have been conducted solely on Vertikalny ore and the results are assumed for pit optimisation studies to apply equally to Mangazeisky ore. The metallurgical characteristics of the Mangazeisky deposit may not be the same and it is strongly recommended that further testwork be conducted on representative samples as soon as possible, including locked cycle flotation tests on all the major primary ore zones that form part of the LOM plan.

SBR has conducted ore sorter testwork on samples of oxide ore from current production. Based on these results, the current schedule assumes that approximately 270ktpa of ore will be mined with 180,000ktpa reporting to the flotation plant after crushing and ore sorting with 99% recovery of Ag, Pb and Zn to the flotation feed. This applies to both oxide and sulphide ore. The ore sorter is scheduled to be commissioned in April 2020.

If the actual overall mass split of 45% of ROM ore to flotation plant feed, obtained during the testwork, was used instead of the 66% in the schedule, this would result in a much smaller capacity plant (122ktpa) and therefore significant savings to capital costs.

The installed capital cost for the ore sorter and associated infrastructure is estimated by SBR at \$2 million and the additional operating cost as \$2.25/t of ore sorter feed.

### **17.5.1 Risks**

Some of the risks to be evaluated are the following:

- Testwork should be conducted on Mangazeisky primary ore to confirm flotation response;
- Full elemental analysis should be conducted on samples of the final Pb and Zn concentrates to determine the effect of any penalty elements and to obtain an up-to-date NSR from suitable smelters;
- Ore sorter testwork was conducted on oxide ore only and should be conducted on primary ore to confirm response and the high metal recoveries, in particular for Zn;
- Another FEL is likely required for the ore sorting operation, the current plan is to use the same FEL as for feeding the primary crusher, otherwise there is risk to production from low FEL availability;
- Throughput for 2020/2021 through the existing plant may be lower than scheduled depending on the amount and hardness of the sulphide ore in the blend;
- The current schedule assumes minimal time for a final tie-in of the upgraded plant (flotation circuit, additional crushing and grinding capacity).

## 18 INFRASTRUCTURE

The following Chapter has been based on the Tetra Tech (2017) NI 43-101 and updated where necessary to reflect the current status of the Project.

### 18.1 Introduction

The Project achieved the first silver production in April 2018 and during the three-month period to 31<sup>st</sup> March 2021 mined a total of 25.2kt, processed 23.8kt at an average grade of 645g/t Ag producing some 436koz of silver at a recovery of 90%. In 2020, the Project mined 114.9kt, processed 109.5kt at an average grade of 645g/t Ag, and produced some 1.9Moz of silver (recovery 85.4%).

### 18.2 Logistical Infrastructure

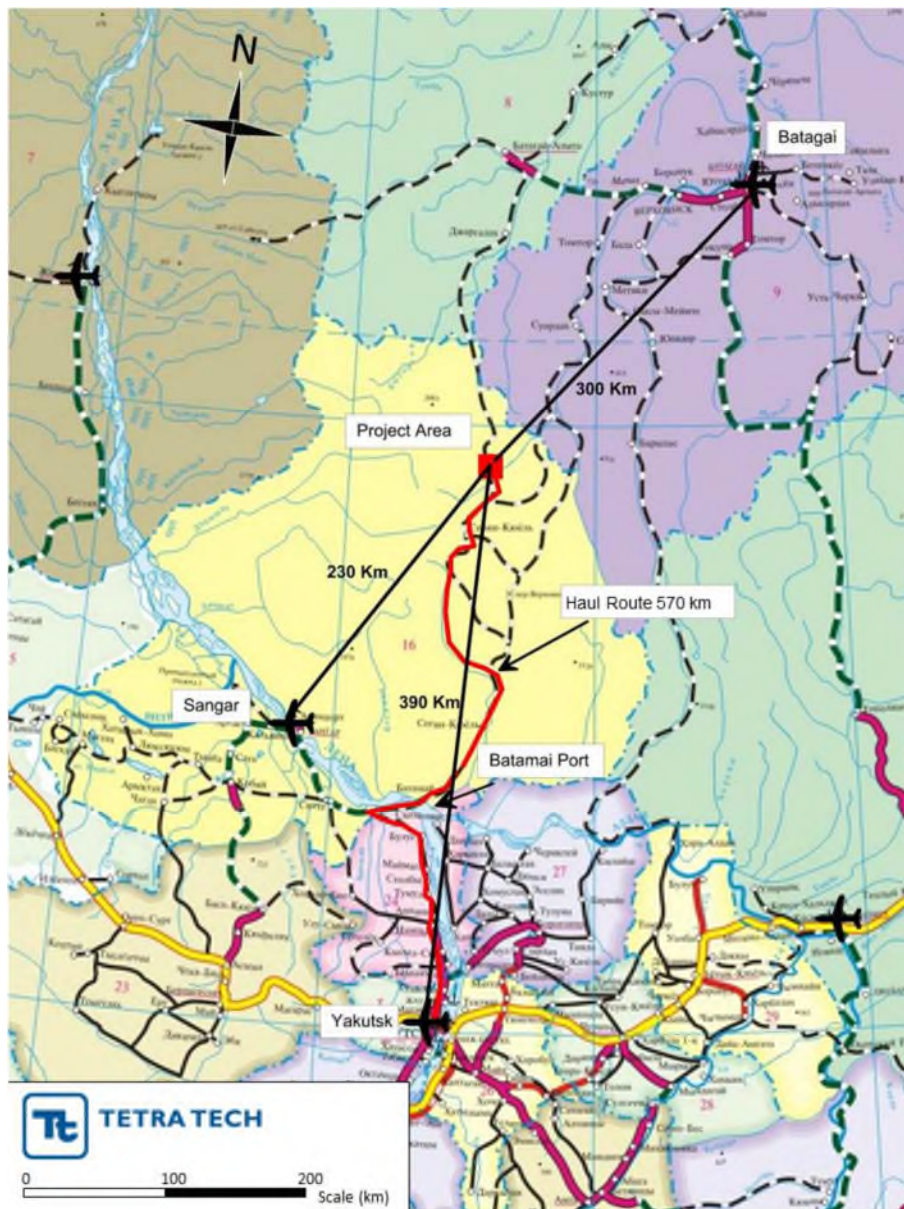
The remote location of the Project, and the seasonal availability of the main access route, prioritises the logistical infrastructure in order to keep the supply routes open with goods and personnel. Supplies and equipment are consolidated in Yakutsk, and the regional ports, before being transported to site during the three to four months that the winter road is open. For the best part of nine months of the year, air travel is the only reliable transport to site. Therefore, the Project has sufficient warehousing and storage for a minimum nine-month supply of goods, spares, and consumables that are transported to site during the limited period that the access road is open.

The area is serviced by a number of public winter roads serving villages on route to the Project, the nearest of which is used by reindeer herders during migration, thus requiring extra care by traffic some temporary hold up. The winter roads are typically usable between mid-December and mid-April (varying from year to year), with the local Sakha authority responsible for determining when the road is open, and granting permission for the road to be used.

The current haulage route is shown in Figure 18.1 and the distance by road from Yakutsk to the Property is 570km. Road maintenance is carried out by specialist contractors under the direction of Prognoz, with the maintenance burden increasing in line with road usage. Prognoz structure their maintenance around the requirements of truck movements though the burden increases during severe conditions, or after a big flood season.

Historically, SBR has moved up to 50t payloads on the winter road for one off special loads, such as a Caterpillar D9 bulldozer. For the 2015/2016 winter road season, the road was upgraded to provide a reliable route for process equipment delivery, in addition to regular bulk deliveries of construction material, spares, and consumables. During normal operation, fuel deliveries make up the bulk of the loads delivered to site.

Access from Batamai to the north via a winter road has been possible historically; however, during the last 20 years the road has had no funding and had run into disrepair. The road could be used in exceptional circumstances.



Note: Red outline = project area; black lines = existing gravel roads

**Figure 18.1: Regional Transport Routes (Tetra Tech 2017)**

### 18.3 Site Layout and Construction

The Project site layout shown in Figure 18.2 and presents the location and orientation of the three main mine site components:

1. Vertikalny open pit area and underground mine.
2. Process plant facility.
3. Supporting site infrastructure, encompassing all roads, buildings, facilities, and structures that support, but do not directly contribute to, the primary purpose of the mining operation.

The site layout design philosophy was to keep the site as compact as is practical (in order to minimise environmental and social impact), keep haul and pumping distances as short as possible, and minimise the amount of surface water that will have to be managed as a result of infrastructure interference. However, the mine site layout is constrained by:

- Property licence area;
- Sirelendge River to the north and east of the mine site; and
- Topography of the mine site.

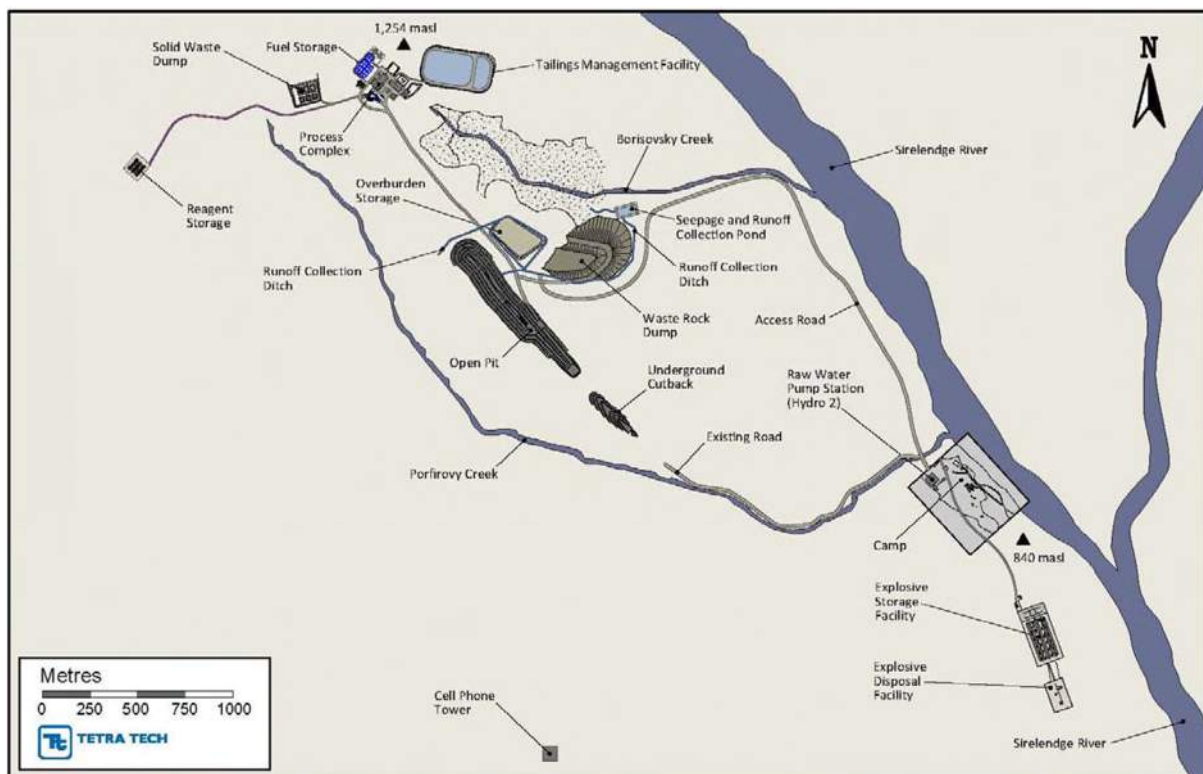


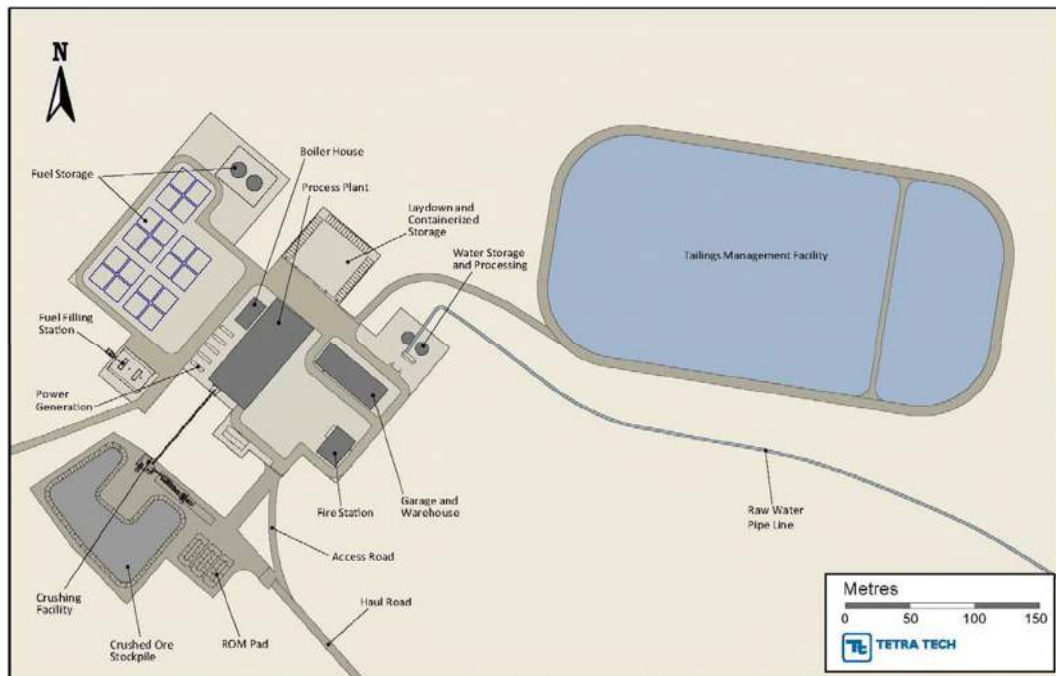
Figure 18.2: Site Infrastructure Layout (Tetra Tech 2017)

Local meteorological conditions, as well as the location of equipment, buildings, and storm drainage, were taken into consideration during the site layout design. The process plant is set on the hill top at the closest suitable location to the pit to minimise haul distances, and is oriented to take into account the prevailing wind direction (northeast and southwest). Similarly, the camp site is located on an

elevated plateau, at the junction of the Sirelengde River and the Porfirovy Valley, while the storage area is located approximately 25m above the adjacent river level (Figure 18.2).

It should be noted that construction of camp and storage buildings required the removal of peat and ice pockets, and the spreading of cobble and boulder-like fill, in order to provide appropriate subgrade for the foundations of buildings. It is assumed that all peat and ice was removed from beneath all existing structures, wherever those pockets were intercepted.

The plant site layout (Figure 18.3) is based on the concepts of maximised operability, maintainability, and general safety. Special design attention was given to the positioning of process and other equipment in the plant layout to ensure direct and efficient flow of material from the ROM feed point, through to the silver powder production room, minimising conveyor lengths and piping runs.



**Figure 18.3: Process Plant Facility Layout (Tetra Tech 2017)**

The process plant, the dry stack TMF, and all related structures are located across the northern most part of the Project site, on the top of the mountain. The area is generally flat, with gentle slopes leading toward the edges of the plateau, where the surface then drops sharply into the adjacent valleys. The elevation difference between the plant site and the nearby Sirelengde Valley is approximately 400m. The ground conditions across the plant and TMF areas are generally represented by weathered rock overburden over shallow bedrock.

Construction of all Project infrastructure has accounted for encountered ground, and meteorological conditions including the presence of permafrost. The approximate thickness of the permanently frozen ground at the Project site is between 300 and 400m. Construction of building foundations and other engineered structures in these areas required specific knowledge regarding permafrost and specialized construction techniques to mitigate potential issues.

#### **18.4 Site Roads**

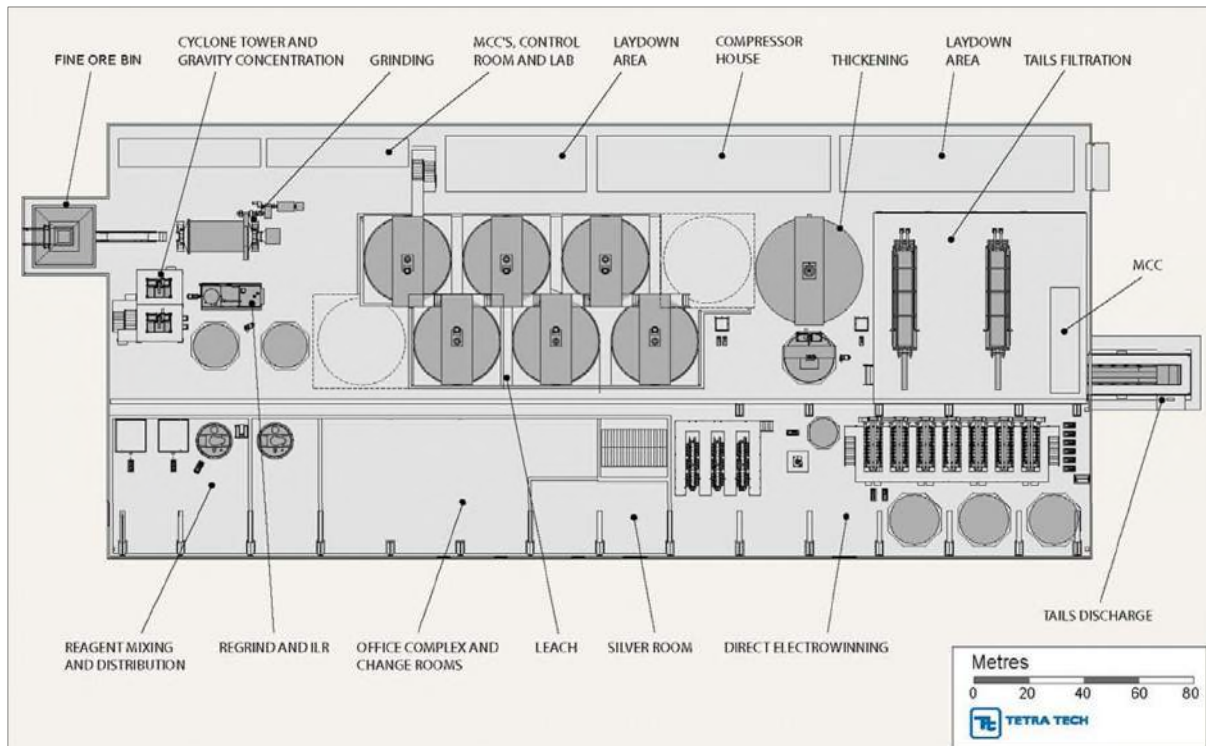
A newly airstrip is located on top of a hill approximately 1km west of the Processing Complex. The length of the airstrip is 750m, which is sufficient to accept An-2 and An-3 type airplanes as well as helicopters. Internal roads across the Project site connect the camp site; the process plant; the open pit; and the ore, tailings, waste rock, and other storage facilities. The width of the road is dictated by the specifications of the widest vehicle traveling on the road, this is the CAT 740 articulated dump truck. Based on the truck's specifications, all mine roads will have a minimum width of 9.8m. This width includes the two shoulders and the minimum safety distance between two trucks driving next to each other in opposite directions.

#### **18.5 Processing Facility**

The design of the processing facility takes into account the remote location of the Project and the logistical constraints of the winter road transport window. The general approach is to ensure that machinery and equipment located outside of the building is specified to Arctic grade to allow for operation and maintenance in the extreme cold environment. Equipment is laid out to keep pipe and cable runs as short as possible, whilst maintaining the operability and maintainability of the plant and the facility is run on low-voltage power.

The main process building is winterised and heated to keep the internal temperature within 10°C and 35°C depending on the season, occupying an 84m by 24m portal frame structure. The majority of the process equipment, apart from the crushing circuit, is located within the process plant building, and the plant and buildings are laid out to ensure that personnel do not have to unnecessarily venture outside and where necessary to keep distances to a minimum.





**Figure 18.4: Process Plant Layout (Tetra Tech 2017)**

## 18.6 ROM Pad and Crushing

The ROM pad and crushing facility is located outside to the southwest of the process plant. The mine haul trucks carry ROM ore to the ROM pad, which is comprised of three graded piles. The ore is then fed into the crusher plant by a front-end loader. During periods of dry weather, as required, ROM pads and stockpiles will be sprayed with water to suppress dust emissions. The crusher facility comprises two skid mounted modular crusher units, bolted to a reinforced concrete slab, and a fine ore bin feed conveyor.

## 18.7 The Mill

The ore feed enters the process plant via a vibrating feeder at the base of the fine ore bin located in the western corner of the process plant, discharging onto the ball mill feed conveyor. The ore discharges from the ball mill feed conveyor into the ball mill feed chute where it enters the ball mill alongside the mill classifying cyclone underflow product and process water. The ball mill is a 3m diameter by 3.9m, 500kW ball mill set on a concrete foundation, charged with 90mm diameter steel balls and must be topped up at a rate of 1kg of steel balls per tonne of ore processed by the mill, which equates to a feed of five balls per hour.

## **18.8 Power Supply and Distribution**

Five 645kW diesel generating sets are installed to meet the load requirements of the process plant site. Remote sites such as the camp facilities are by separate power generation. The mine power requirements will change when the flotation facility is put into production (2023) and underground mining commences (2024).

The power station is located adjacent to the process plant building (Figure 18.3). The generating sets feed directly on to a 400-V switchgear assembly, located in an air-conditioned, prefabricated building included within the power station package scope of supply. The power station switchgear assembly contains feeders for distribution of power to the MCCs within the process plant building and for power station services as required. Power is reticulated throughout the building on cable ladder attached to building supports or process equipment walkways and support structures. Three phase low-voltage supply to motors and other services will be 400 VAC. Roadway and plant lighting will be installed throughout the plant for 24-hour operation.

## **18.9 Tailings**

### **18.9.1 Handling**

Dewatered tails are released from each filter press onto a cake discharge conveyor running under each filter press. The conveyor discharge cake onto a common conveyor running perpendicular to the filter presses, which will transport the cake through a portal on the northeast side of the building to discharge to a stockpile.

After dumping the ore on the ROM pad, every third ore truck will continue round the process plant building to be loaded with tails from the tails stockpile by a front-end loader. The ore truck will proceed to the TMF, 250m to the east of the processing facility, and dump the tails in the TMF before proceeding back to the open pit.

### **18.9.2 Tailings Management Facility**

SRK Consulting undertook a Tailings Management Facility (TMF) site selection study, in which a series of four alternative locations were assessed for development. A waste rock and tailings co-disposal option was also considered as part of this assessment. The preferred location for TMF development is indicated in the site layout in Figure 18.2. The TMF is located 0.2km northeast of the plant site and will cover an area of 7.69ha. Approximately 0.8Mt of tailings material will require storage over the LOM.

Tailings material is dewatered at the plant to produce a filter cake, with a minimum solids content of 85% w/w. This dewatering methodology was selected by Tetra Tech and SRK to minimise potential impacts on the environment and simplify materials handling. As the tailings material was identified as having potential for metal leaching, the TMF is a fully-lined facility. There will be zero discharge of process affected fluids. To achieve this goal, runoff and any seepage water is collected in the

clarification pond, located at the eastern end of the TMF. The water will then be processed in the treatment plant and used as make-up water in the process circuit. Limited materials testing has been carried out on representative tailings samples, which indicate that the material consists of predominantly fine grained material.

The TMF consists of two components:

- Filtered tailings (or dry cake) storage area; and
- Clarification pond.

The waste storage area of the TMF consist of a high-density polyethylene lined pad surrounded by a rock fill perimeter berm. The perimeter berm will vary in height and its function will be to separate the clean surface water (runoff water from the surrounding topography) from the process affected water (runoff water from the dry cake storage area). At the eastern toe of the TMF waste stack, a fully lined clarification pond is located, with the seepage collection sump at the downstream end of the contained area.

Tailings is delivered to the storage site in the form of dry cake at 12 to 15% moisture content using a haul truck sourced from the mining fleet. Tailings are loaded from the stockpile outside the plant onto the truck using a dedicated backhoe loader and upon deposition, are spread and compacted by a D7 dozer (also sourced from the mining fleet).

A closure and progressive rehabilitation plan has been completed for the TMF, which incorporates the following components:

- Re-grading of the TMF to ensure all external slopes are less than or equal to 1V:3H;
- Placement of 1.5mm HDPE geomembrane across the stored tailings material;
- Placement of a geotextile protection layer above the HDPE;
- Installation of a 1.0m waste rock layer for erosion protection; and
- Installation of a 0.2m topsoil final cover.

The final tailings surface has been designed to encourage shedding of meteoric runoff to the perimeter of the structure. Monitoring provisions are included for both the operational and closure period, which include standpipe piezometers for water quality monitoring.

### **18.10 Waste Rock Dump, Ore Stockpile and Overburden Storage Area**

The three types of soil and rock streams that will require temporary storage or permanent disposal at selected locations across the mine site are: topsoil/overburden (generally weathered rock fragments), ore, and waste rock. The selected locations for the temporary storage or permanent disposal of these materials are shown in Figure 18.2.

### **18.10.1 Overburden**

Soil overburden was removed from all sites where construction dictated. The material generally comprised variable amounts of clay, silt, sand, gravel, cobble, and boulder sized rock fragments and soil particles. Prior to pouring foundation concrete for the individual buildings, and prior to the start of the open pit, all soil overburden was removed from those areas and stockpiled for potential re-use during mine closure. Since the largest amount of such soil mass is expected to come from the open pit area, the temporary storage place for the topsoil will be next to the open pit (Figure 18.2).

The overburden storage has a footprint of approximately 35,640m<sup>2</sup> and available volume in excess of 200,000m<sup>3</sup>. A runoff collection trench formed around the storage heap collects any storm water and conveys it into a collection and settling pond, to capture all solid particles and prevent those particles from entering the Borisovsky Valley.

### **18.10.2 Ore Stockpile**

Ore from the open pit, and underground mine, will be transported to the process plant by dump trucks. Prior to crushing, the ore is stockpiled in four individual areas located immediately southwest of the plant. Three smaller heaps (circa 460m<sup>3</sup> each) are formed to store run of mine ore of different grades in order to supply product of the correct specification to the adjacent fourth (circa 12,300m<sup>3</sup>) stockpile, immediately to the northwest, where the mixed ore will be placed next to the primary crusher.

Ore stockpiles are located next to the process plant and no runoff water is expected to come into contact with the dumps, and only a limited amount of precipitation will enter the voids of the ore, which will eventually end up in the process plant. As a mitigating measure, contact water around the dumps is collected in ditches and re-used in the process plant via the TMF. Any water collected will be transported to the TMF via mobile bowser.

### **18.10.3 Waste Rock Dump (WRD)**

The WRD will store up to 2,765,000m<sup>3</sup> of blast rock material (generally comprising gravel, cobble, and boulder sized fragments), from both open pit and underground development, and will be placed into a short side valley located immediately east of the open pit (Figure 18.2). Upon completion of the mining operation, and waste rock disposal, the WRD will attain a maximum height of 135m, with a footprint of approximately 114,260m<sup>2</sup> (11.4ha). The maximum height of each lift of the waste rock is limited to 30m. A seepage and runoff water collection and settling pond is located at the front of the rock dump.

Geochemistry tests were completed by the Russian Laboratory of Geoelectrochemistry No. 571, under the supervision of Institute of Oil and Gas Geology and Geophysics on representative waste rock (and tailings) samples to evaluate the neutralizing potential of these materials using Sobek's method. As part of the testing programme, experiments of intense oxidation on 26 selected samples (24 waste

rock samples and 2 tailings samples) were completed, together with the evaluation of acid-generating potential (AP) and neutralizing potential (NP) of overburden rocks and tailings.

The amount of sulphur in the rock samples was relatively low and exceeded 1% in only three rock samples and in both of the two tailings samples, in nine samples the sulphur content was >0.5%, and in the remaining samples it was <0.5%. In seven samples sulphur content was below the detection limit of 0.01%. The distribution between various forms of sulphur (sulphate and sulphide) in sulphide rocks was sporadic; however, sulphide sulphur prevailed in the tailings samples.

The carbonate content in the waste rock samples varied widely from <0.01% to 10% carbon dioxide. In 16 samples the carbonate content was >2%, but in 16 other samples, it was <1%. In general, on the basis of definition of sulphur forms, the preliminary conclusion is that the overburden rocks have relatively high potential for in-dump neutralizing of any acid that may potentially be formed during oxidative dissolution of any sulphides that may be present in some waste rock streams. The analysed overburden rocks and tailings samples of the Vertikalny deposit that will be placed into the waste rock dump and TMF, are characterized by a high-neutralizing potential.

More than 50% of the samples (23 rock samples and both tailings samples) indicated that they are not acid producing, with a high percentage of calcite content in the tested samples. In fact, in three of the samples the calcium carbonate content exceeded 100kg per 1t of rock. There were a small number of test results that indicated uncertainty in connection with neutralizing potential; however, none of the tests indicated specific potential for acid rock drainage (ARD) in the waste rock.

### **18.11 Site Water Management**

A water balance model (WBM) was constructed for the Project using GoldSim, a software package designed to perform Monte Carlo simulations (GoldSim Technology Group, 2010). The WBM predicts the amount of water required to meet the needs of ore processing (milling) operations, underground mining (drilling) operations, and onsite Project staff based on the best available information.

During open pit mining in the first three calendar years of the Project (2018 to 2020), the maximum average groundwater demand is approximately 62m<sup>3</sup>/d, which occurs during the initial winter period when all new ore processing water will need to be derived from groundwater and when the number of workers temporarily peaks at 210. The total water demand will rise fairly abruptly when underground mining begins and the number of workers increases. The maximum average water demand (218m<sup>3</sup>/d) occurs in the winter of 2023 when the labour force is at a maximum (300 people), underground mining operations are active, ore continues to be processed, and the Sirelendge River is frozen. The annual cumulative total groundwater estimated demand suggests that the greatest amount of groundwater usage will likely occur in 2023, when approximately 52,000 to 60,000m<sup>3</sup> of groundwater will be required.

Based on the WBM and the assumptions made, with >95% confidence, the monthly average groundwater demand will not exceed 250m<sup>3</sup>/d during the life of the Project.

## **18.12 Waste and Sewage**

Regulations state that waste on site is not allowed to be disposed of by burning. Solid waste is therefore stored in the solid waste storage facility, located to the west of the processing facility (Figure 18.2). The solid waste storage facility is lined and segregated to handle different waste streams.

A containerised sewage treatment plant is located at the camp. Sewage from the processing facility washroom is trucked to the camp sewage treatment plant for processing. Daily water requirements are in the region of 350 l/d/person, generating approximately 35m<sup>3</sup> of clean waste water from the sewage plant. When the Sirelendge River is flowing, the clean treated waste water is discharged into the river and the solid, treated cake trucked to the TMF and stored with the tails. During periods that the Sirelendge River is not flowing, the clean, treated, waste water is taken by bowser to the TMF for storage where the effluent is treated as TMF runoff.

## **18.13 Site Facilities**

### **18.13.1 Garage/Warehouse**

Located to the east of, and running perpendicular to the main process plant building, the garage workshop building is a previous 40m by 20m by 8.4m high warehouse building, with a newer 20m by 20m garage extension to make a new 60m by 20m building clad with Russian specified and supplied sandwich panels to provide insulation and weather protection.

The 20m garage extension houses three vehicle bays, each with roller shutter door, designated a vehicle wash down bay, a welding bay, and a repair bay with an under vehicle access pit. The welding and repair bays are serviced by a 5t gantry crane. The 40m workshop section of the building contains a mezzanine floor for storage of lightweight spares. The ground floor of the workshop section contains general workshop equipment such as hydraulic jacks, drills, sanding machines, pullers, and compressors. In addition to the general equipment there will be specialist sections for tyre change and storage, axle maintenance, engine and gearbox maintenance, battery charging and brake maintenance, as well as a foreman's office and washroom facilities. During periods of extreme weather when mining operations are shut down, the unused vehicle maintenance bays will be used to park some of the mining fleet to prevent them from getting too cold for restart.

### **18.13.2 Fire Station**

The fire station is located within the process plant complex. The station is a steel construction and clad with Russian specified and supplied sandwich panels to provide insulation and weather protection. The building contains covered parking for the fire fighting vehicles with water tank refill equipment and roller shutter door, shift office, changing room, training room, equipment stores and a mess room.

### **18.13.3 Operation and Construction Camp Accommodation**

The operational camp facilities is located in the valley bottom next to the Sirelendge River, and is an expansion of the original exploration camp. Phase one of the camp accommodation comprised a two storey, 12m by 49m, 80 bed accommodation block, mess facilities and food storage for 80 workers, a 128m<sup>2</sup> bath and laundry complex, and warehousing for housekeeping maintenance spares, food, and consumable storage. The second phase comprised a second two storey, 12m by 49m, accommodation block configured with 40 beds with the remainder of the building housing rest and recuperation facilities. Water is supplied via a containerised potable water plant, from the raw water pump station. The camp has its own 645kW generator and fuel storage, used to provide power to both the camp and the raw water pump station.

There is a medical centre located at the operational camp with a doctor on site. Injured and sick workers will be transported back to the camp in site vehicles for treatment.

### **18.13.4 Airstrip and Helicopter Pad**

The runway is approximately 800m long, though can be extended to 1,200m, and allows access to site via helicopter or an Antonov AN2 fixed wing aircraft. As neither of the aircraft mentioned can fly above 3,500m in altitude, and the site airstrip does not have telemetry, lost flying days are estimated to be between 50 and 75% due to poor weather conditions. To mitigate for the risk of lost flying days, the shift rosters are staggered and the secure silver store room has the capacity to hold several week's production of silver powder. A helicopter landing zone is designated at the camp area and clinic and helicopters will be used for medical emergency evacuation.

### **18.13.5 Site Storage**

#### **18.13.5.1 Reagent Storage and Handling**

Due to the Project site remoteness and transport challenges, reagents will be stored in bulk with a minimum capacity of a nine month supply. Reagents are transported to site in shipping containers and stored in a dedicated fenced secure storage area (Figure 18.2). The containers sit on a lined pad with drainage channels and sumps to catch surface runoff, which will be sent for treatment.

The containers remain closed and locked until required and are within the process plant reagent mixing facility for unpacking where appropriate ventilation and personal protection equipment is available for workers to unpack the container. Empty containers are sealed and sent back to the reagent supply company for refilling.

#### **18.13.5.2 Explosives Storage and Handling**

The explosives plant and storage facility is located to the south of the Project site (Figure 18.2), an appropriate distance to maintain the recommended safety zone from the camp and occupied buildings and within a high-security fence, and with sufficient capacity to meet the annual explosives

and initiation product requirements. Access and entry is manned by security guards and only limited personnel will be authorised to enter the facility and all material transfers will be controlled by the permanent security personnel.

The plant has a separate bunkered magazines for containerised storage of ammonium nitrate and initiation devices, office, workshop, and change room facilities. The bunkered magazines are placed a safe distance from the rest of the plant and from one another to ensure a safe and secure location for the high explosive and the initiation devices.

#### ***18.13.5.3 Fuel Storage and Handling***

Diesel and lubricants are transported from a storage facility in Batamai during the winter road season. The fuel farm comprises 12m diameter steel storage tanks with a capacity of 6,000m<sup>3</sup> of diesel. The total fuel consumption per annum and hence, storage required, is approximately 6.4MI (including 15% contingency). Almost all of the diesel supply (4.2MI) will be consumed by the process power station.

A refuelling point next to the fuel storage (Figure 18.2) will allow mine fleet and light vehicles to fuel up in a specially equipped area to contain spillage. Spent fuel and lubricants is drained and stored in drums or approved vessels at a designated area of the fuel storage facility.

#### ***18.13.6 Assay and Metallurgical Laboratories***

The metallurgical laboratory will be a containerised laboratory located within the process plant and will handle approximately 10 samples per day. The facility will prepare samples (crushing, splitting, milling, etc.) before testing with flotation, bottle roll, titration, and pressure filter equipment.

A geological laboratory is located within the camp area, within close proximity to the core logging building. The geological laboratory will process the wet chemical assays from the mine, process plant, and exploration.

#### ***18.13.7 Communications***

The site wide data and voice telecommunications for the Project is provided by a Russian cellular network provider. SBR has installed a mast on the hill to the south of the main pit (Figure 18.2) and to this, the cell phone company install their equipment and infrastructure.

The communications systems for the Project includes a telephone system, two separate LAN networks and datalink to the world wide web, television surveillance system, loudspeaker and alarm communications systems, and telecommunications cabling to all buildings.

The LAN network includes all cabling, equipment and infrastructure for connection to each building within the process plant area and to remote sites. Cellular mobile telephones and communication equipment provide the functions usually covered by site very-high frequency (VHF) radio. The cellular mast and transmission equipment will be installed and maintained by the cellular network provider.



#### **18.14 Site Security**

Pedestrian and vehicular access to the site is controlled to provide security for personnel and property and to manage the risk of injury at the mining and processing operations. The remote location of the site, and the site topography, eliminate the need for full perimeter fencing; however, high risk areas such as the explosives facility, reagent and cyanide storage and the power station is locally fenced. Whilst the majority of personnel on site are operational staff, consideration is given to the seasonal nomadic reindeer herders that pass through the area.

#### **18.15 Remote Site Facilities**

The Project is remotely supported by management, administration and engineering teams based in an office located in Yakutsk. Dried silver powder, in sealed and tagged 30l HDPE drums flown from site, are transported directly to a third party refinery from where doré metal is sold directly. Once the silver metal powder arrives at the airstrip near Yakutsk, no handling (other than off-loading from the plane) or storage of silver metal by Prognoz will be required.

## 19 MARKET STUDIES AND CONTRACTS

### 19.1 Product Realisation

The main products from the Mangazeisky Project deposit are proposed to be silver bullion and two concentrates: silver bearing zinc concentrate and silver bearing lead concentrate.

Silver bullion as precious metals is always in demand among the Russian banks. WAI notes that SBR has currently got an established cooperation and signed agreement with a Russian bank for realisation of silver bullion.

Zinc concentrate is expected to be produced at 42.3% Zinc and average 1,133g/t Silver and is considered to be saleable based on typical western smelter contracts.

Lead concentrate brings 74% of the overall project NSR on the strength of its silver content. And according to the testwork results, is assumed to be produced at 17% lead and 10,215g/t of silver. WAI was advised that both lead and silver payable content is expected to be around 84% to allow for realisation of a lower grade concentrate and smelter costs.

In due course of this study, silver content (in lead concentrate) has been estimated at 2,929g/t vs 10,215g/t. The difference in concentrate grades is explained by variance in head grades of feed materials. Whilst the historical testwork sample contained 1.8% of lead and 702g/t of Ag, WAI production schedule provides 5.8% of lead and 723.9g/t of silver in the flotation plant feed. With the much higher lead head grade than what was tested, an estimated theoretical concentrate yield resulted in 20% vs 4.5% shown in testwork results. This mass pull and concentrate yield was considered too high in practice given that variation in head feed grade ranged <10% for concentrate yield so WAI decided to run a preliminary scenario with mass split being set at 5% and using all other parameters as per testwork results and original payment terms. This exercise resulted in improved lead concentrate quality of 66% of lead and 10,026g/t of silver, and improved project economics due to significantly reduced concentrate shipment costs.

*WAI comment: Caution is urged in interpretation of this scenario given the high variability in feed grade and other variables, including a lack of definitive testwork and further testwork is recommended to confirm potential improvement of the lead concentrate. WAI has utilised 17% lead content assumption in order to derive financial results presented in this report (as the base case).*

Zinc concentrate is expected to be produced with 42.3% content of zinc and average 1,133g/t Silver.

Although lead concentrate is expected to be of a lower grade than is typically accepted on the market, (60-70% Pb) it is assumed to be sold to a smelter in Kazakhstan on the strength of the Ag grades (10,215g/t Ag in the Pb concentrate). There is also a potential route of realisation to China. Considering that production of zinc and lead concentrates is scheduled to commence in the end of 2021 – beginning of 2022, there is currently no official agreements between SBR and potential off-takers. Concentrate realisation arrangements are planned to be set at the following stages of the project

development. Provisional agreements will help to minimise risk of uncertainty in realisation terms for lead and zinc concentrates.

WAI notes that Mangazeisky project value is mostly formed by silver content, and therefore significantly less sensitive to change in lead prices. Therefore, an impact from the potential changes in payment terms for lead and zinc prices are considered moderate to low.

## 19.2 Commodity Market Outlook

All costs assumptions and commodity prices used in this study have been estimated as of the end of 2019.

Table 19.1 provides a summary of commodity prices used in the preliminary economic assessment (PEA) and mine design. These assumptions have been based on the SP Angel Report dated 27 Aug 2019 and with consideration of the World Bank Commodity Market Outlook.

Although, the prices outlined below may look relatively optimistic given current market conditions, WAI notes that project break-even silver price has been estimated at US\$14.48/toz, which is six percent below the current spot prices that is ranging between US\$15.35/toz - US\$15.55/toz (May 2020).

Latest World Bank's Commodity Market Outlook (published in April 2020) suggests that albeit Silver prices declined to levels unseen since the global financial crisis in March, precious metals prices are expected to average 13.2% higher in 2020, with silver prices being also anticipated to recover moderately later in 2020.

<b>Scenarios</b>	<b>Price Assumption (as of 2019)</b>
Ag (US\$ / oz)	17.76
Pb (US\$ / t)	2,069
Zn (US\$ / t)	2,252

## 20 ENVIRONMENTAL STUDIES, SOCIAL IMPACT AND PERMITTING

The following Chapter has been based on the Tetra Tech (2017) NI 43-101 Technical Report and updated where necessary to reflect the current status of the Project.

### 20.1 Existing Environmental Conditions

Existing environmental conditions are described based on ERM (2016b) a part of the Russian design documentation. The surveys included field works, laboratory, and desktop studies performed by ERM consultants involving local experts and scientific institutes. Report has been prepared in Russian only.

#### 20.1.1 Physical Environment

The Project is located in the Kobyaysky District (Ulus1) of the Sakha Republic in a highland with altitudes of 800 to 2,200m. A seasonal winter road connects the Project to port facilities on the Lena River and the nearest settlement, Sebyan-Kyuel, is 43km south-southwest of the Project site. The Project area is located within the Endybal River basin and the largest watercourses include the Arkachan, Endybal, Sirilende, and Fedor-Yurege rivers.

The Project is located in an area characterized by a continental sub-arctic climate, and is significantly influenced by the mountain relief that causes high wind velocity in elevated areas. The average monthly temperatures for January and July are -38.1°C and +13.7°C, respectively. The frost-free period lasts for 52 days, on average; however, some years have had frost persisting throughout the entire summer. Precipitation of approximately 200mm/a occurs mostly as snow. The approximate number of days with snow cover is 209, and the average snow depth is no greater than 35cm.

Current air quality baseline conditions are below established criteria for carbon monoxide, nitrogen dioxide, sulphur dioxide, and particulate matter. Baseline air quality in the area is dominated by natural sources and limited to dust from wind erosion, primarily just after snow and ice have melted and under dry conditions. However, available data is limited due to the remoteness of the site and activities limited to ongoing exploration. The air quality in the Project area is within regulatory maximum permissible concentrations (MPC).

The river system in the Project area consists of the Sirelendge River and its major right-bank tributaries: Borisovsky Creek and Porfirovy Creek, with a tributary, Sukhoi Log Creek. This is the basin of the Yana River which flows into the Arctic Ocean. Preliminary laboratory tests indicate that concentrations of minerals in some surface water samples and bottom sediments exceed regulatory standards (maximum permissible concentrations for fishery water bodies (MPCf2). These elevated concentrations are attributed to natural weathering processes across the Project affecting regional watersheds, and to exploration activities in local waterways near the Vertikalny deposit area. The feasibility study does not include an allowance to remediate any historical impacts that may be caused to date by Project activities. Preliminary analysis suggests elevated concentrations of magnesium, iron, manganese, aluminium, strontium, copper, zinc, cobalt, nickel, cadmium, lead, and selenium in surface water and elevated metal concentrations of cadmium, lead, nickel, zinc, and arsenic in bottom

sediments. Terrain of the Verkhoyansk Range is primarily defined by seasonal water erosion during the spring snow melt and storm rainfall that results in eroded low areas separating topographic highs. This seasonal water erosion also defines slope processes in the Project area. Other geological and hydrological processes that affect the Project area terrain include:

- Cryogenic, including frost splitting, seasonal heaving, solifluction, desorption, frost sorting, stone-run formation, thermokarst;
- Gravitation: slides, landslides, landfalls, mudflows, avalanches; and
- Fluvial and hydrological: erosion, swamp formation, and ice formation. Permafrost conditions are approximately 230 to 350m below ground surface, reaching thickness of up to 400 to 500m on larger plateaus. This is the main factor defining engineering and geological characteristics of the area. Seasonal freezing of the near surface material is relatively fast. On average, it takes two months; freezing speed exceeds 1 cm/d.

Groundwater of the Yana-Indigirka basin consists of two hydrogeological levels:

- Perched water, seasonal thaw depth (active zone) water and taliks (under lakes); and
- Connate water within the cracks and pores of the underlying geologic material below the permafrost zone.

Water within the perched, active zones and talik is insufficient for use at the Project process facility and for drinking due to poor quality and limited/seasonal availability. Additional studies confirm the availability and sufficiency of in frapermafrost water to be used for the Project water supply. Based on the work completed by SRK, ERM is not aware of any environmental or regulatory constraints preventing the use of this water for this purpose.

### **20.1.2 Biological Environment Soil**

Soil in the Project area is poorly developed, acidic, and has a high proportion of stones and debris. The soil is also affected by cryogenic deformation and thixotropic and supra-permafrost gleying resulting in limited soil regeneration. Common soil types of the area and their associated location and vegetation community are summarised in Table 20.1

<b>Table 20.1: Summary of Terrestrial Ecosystem Communities</b>	
<b>Soil Type</b>	<b>Location / Community</b>
Typical brown soils	Cowberry-lichen tundra and upper taiga open woods at narrow watersheds and steep slopes of the middle taiga zone (10%)
Podzolised cryosolic soils	Larch moss-cowberry forests in river valleys
Mountain tundra typical and gleyic soils	Mountain tundra belt on well drained and poorly drained flat areas
Dry-peaty brown and high moor peaty brown soils	Middle and lower parts of slopes under ledum-sphagnous larch woods in river valleys and intermountain nicks
Chernozem-like soils	Rare
Alluvial soils	Valleys of rivers and creeks
Al-Fe-humus abrasems (disturbed brown soils)	Anthropogenically modified areas as a result of mineral exploration activities
Meadowed brown soils	Anthropogenically modified areas as a result of mineral exploration activities

Sampling and testing of soils suggest that in accordance with the Russian standard, the vast majority of soils within the Project area can be used, based on their environmental characteristics, without limitation. There have been some contaminated soils identified through field surveys, notably in the area along the access road (near the mouth of the Sukhoi Log Creek). These contaminated soils are likely the result of geological and exploration works that have been conducted to date.

Remediation plans for these contaminated soils that are currently known, and any found during the Project life, will need to be developed to outline measures such as testing, excavation, and either disposal to landfill locations, or blended/layers as part of site pad construction. The feasibility study does not include an allowance to remediate any historical impacts that may be caused to date by Project activities.

#### 20.1.2.1 Plant Life

The Project area is located in the mountains of the Verkhoyansk district of the Bering northern taiga sub-province of Cajander larch (*Larix cajanderi*) forests. Dominant types of plant associations are larch forests and woodlands, and mountain tundra. In valley complexes, chosenia woods and willow shrubs also occur. Protected species identified within the Project area include five species of vascular plants and three fungi species listed in the Red Data Book of the Russian Federation and the Red Data Book of the Republic of Sakha. Four species were identified within 1,000m of Project infrastructure that will require protection. There are also unique ecosystems to these areas that will also require protection. Several small steppe areas that are the relicts of the Late Pleistocene occur only sporadically and are rare in the north-eastern part of Yakutia. Valuable medicinal and food plants occurring within the Project area are cowberry, ledum, blueberry (*Vaccinium uliginosum*), cranberry, dwarf pine (*Pinus pumila*). These species are a wide-spread plant resource across the entire Yakutia taiga, and the due to the remote location, the potential for harvesting volumes in the Project area is low.

#### 20.1.2.2 *Animals*

The diversity of terrestrial vertebrates (wildlife) in the Project area is low due to climatic conditions and specific features of the mountain terrain. In addition, the Verkhoyansk Range, which extends from the Arctic Ocean to the Sea of Okhotsk coast, serves as a natural barrier for the migration of animals. Important wildlife species in the Project area include Snow sheep, elk, Musk deer, and Reindeer that support economic livelihood for local residents and communities.

Other wildlife in the area includes brown bear, grey wolf, wolverine, lynx, sable, stoat and the black-capped marmot. Primary game/fur animals hunted by the local population (i.e. reindeer herders) are squirrel and ermine and, in recent years, sable has been steadily becoming more popular as a game/fur animal. Birds noted in the area include willow ptarmigan, Eurasian sparrowhawk, merlin, common kestrel, golden eagle and Eurasian eagle-owl. The maximum diversity and specificity of wildlife species is observed in river valleys in the mountain forest belt. The lowest diversity is in the forest belt of mountain slopes, specifically in mountain tundra complex.

No amphibians or reptiles occur in the Project area. The majority (50%) of the entomofauna species occur in meadow-type habitats with forests and meadow-forests providing habitats for 24% and 20% of insect species, respectively. The remaining 6% of species occur in mountain-tundra, tundra, bog, steppe, and meadow-steppe habitats.

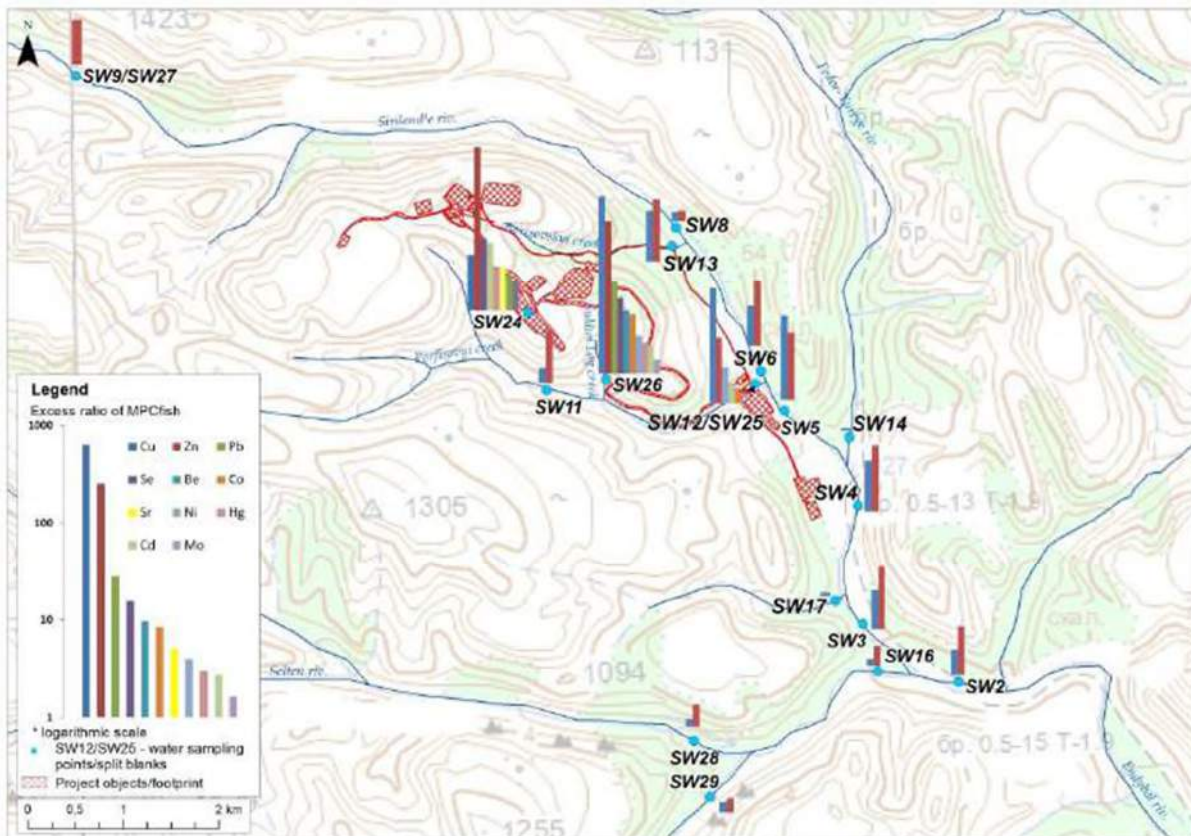
Within the Project area and area of influence there are no species of mammals listed in the Red Data Book. However, the black-capped marmot (*Marmota camtschatica*, Pallas) are registered in adjacent area (N65°42.119 E129°59.219), (N65°43.465 E130°9.588) to the Project. Two species of birds (golden eagle and eagle-owl) and three Lepidoptera species (*Parnassius tenedius* (Ev.), *Parnassius phoebus* (F.) and *Colias hecla viluensis* (Mén.) that are listed in the Red Data Book of the Russian Federation and the Red Data Book of the Republic of Sakha were identified within Project area. The closest nests are located within 1,000m from Project facilities. Monitoring of these nests is recommended during Project construction and operation. Key fish species occurring in watercourses of the Project area are grayling and burbot, both of which are not rare or protected and have no commercial fishing value. Local residents undertake recreational fishing for household consumption. In accordance with the regulations of the Federal Agency of Fisheries, the rivers within the Project area fall under the following fishery categories:

- The Arkachan River can be classified as a water body of the highest fishery category due to the occurrence of *Coregonus lavaretus pidschian* and *Hucho taimen*; and
- The Endybal, Sirelengde and Fedor-Urege Rivers fall under the first fishery category as watercourses used for reproduction, wintering, and feeding of *Thymallus arcticus*.

According to Russian Federation regulatory requirements, the water quality of watercourses with fishery significance should be maintained at the same level, with no contaminants discharged without treatment, assuring the meeting of regulatory standards. As illustrated in Figure 20.1, these waterways already exceed the MPCf; in particular there are elevated copper and zinc concentrations. There are no Special Protected Natural Areas (SPNAs) in the Project area; however, more than 20

SPNAs of local and regional value have been established in the Kobayasky Ulus and other surrounding uluses of the Republic of Sakha (Yakutia) (within a 200km distance from the license area), including one national park, 16 resource reserves, 6 no-take zones, and 5 unique lakes. The nearest SPNAs to the Project are shown in Figure 20.2 and include:

- Echii River no-take zone with an area of 229,800 ha - of the local significance; and
- Unique Lake Sebyan-Kyuyol with an area of 2 071 ha – of the regional significance.



**Figure 20.1: Surface Water Quality Compared to MPC for Water Courses for Fishery Water Bodies (MPCf) [Tetra Tech 2017]**

No Ramsar territories (the Convention on Wetlands of International Importance, especially as Waterfowl Habitat) are located in the Project area of influence. Key bird area “Forty islands” (RU3064) is included in the list of Important Bird and Biodiversity Areas (IBAs) developed by BirdLife International and located within the territory of SPNA natural park “Ust’-Vilyuysky”. It is included in “indirect list” of Ramsar wetlands as it provides habitat and nesting areas for approximately 20 rare bird species, including water fowls.



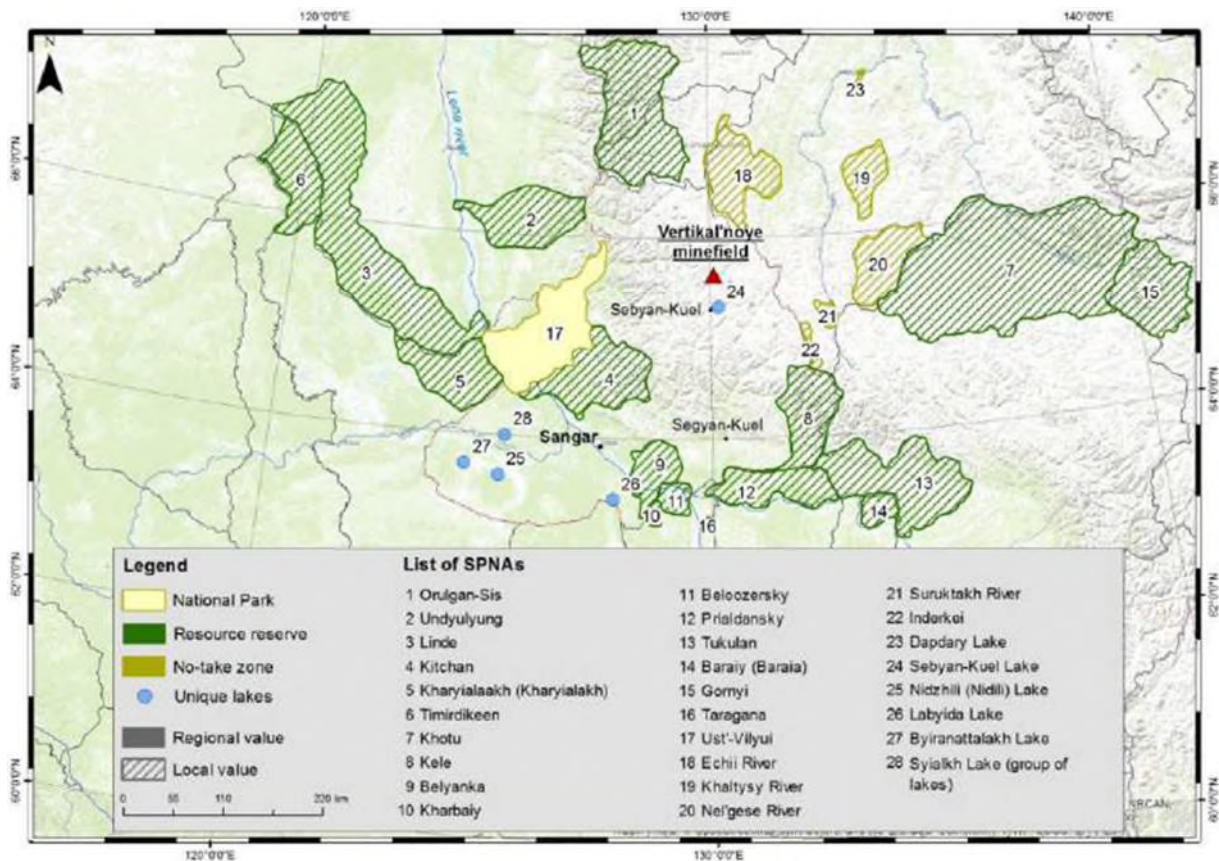


Figure 20.2: SPNAs in the Surroundings of the Project Area (Tetra Tech 2017)

## 20.2 Existing Socio-Economic Conditions

Existing socio-economic conditions are provided based on the report on the results of socio-economic survey performed by ERM in 2015 (ERM 2015). The Project area is located a considerable distance from both the Kobayasky district (Ulus) centre Sangar (approximately 330km by roads or 200km by air) and from the republic administrative centre Yakutsk (approximately 400km by roads). The Project Area is located in the Lamynkhinsky Nasleg ("Nasleg" is the lower level of the administrative territorial division of the Sakha Republic). The Project area is a zone of residential area of indigenous peoples of the North of the Evens (the Evens) (Lamuts): 714 of 773 people of the Nasleg (92%). The Evens are one of the indigenous peoples of the north living in vast north eastern territories of the Russian Federation. The Evens population of the Lamynkhinsky Nasleg is steadily increasing. Remoteness and restricted accessibility have preserved the traditional Evens culture within the Lamynkhinsky Nasleg. Traditional Evens economy is reindeer herding, supplemented with fishing and hunting game for meat and fur. The Evens families are private owners of reindeer herded together with reindeer of State Unitary Enterprise (SUE) Sebyan. The Project footprint and the seasonal access road will intercept grazing areas traditionally used for reindeer herding. SBR has assessed, evaluated and negotiated compensation that will be provided to the affected herders.

Reindeer husbandry in the Lamynkhinsky Nasleg also includes reindeer herders of SUE Sebyan. SUE Sebyan consists of several teams each using its own grazing/herding areas and camping sites; two teams have been using the Project area:

- Team No. 5 traditionally migrates in the area of the abandoned Village of Endybal. The team is comprised of six reindeer herders and three chumkeepers and grazes more than 1,000 reindeer, including 583 heads of SUE Sebyan and privately owned animals. Routes of late-autumn and early spring movements are located near the Endybal village and partly near the Project area. A fawning ground used by the team in April/May is located near the former settlement not far from the license area.
- Team No. 9 of SUE Sebyan migrate near the winter road of regional significance, Batamai to Sebyan-Kyuel. As of March 2015, the herd numbered 1,000 reindeer, including 500 privately owned animals. The team is comprised of six reindeer herders and three chum-keepers. The Evens families have no legal title to land; however, grazing and herding areas of the SUE Sebyan are historic areas determined during the time of the former Soviet Union.

The Evens families of the Lamynkhinsky Nasleg preserve their traditional work as reindeer herders. The local school and community clubs make efforts to preserve the Evens language, national culture, folk songs and dances; however, the economic and social life of the Evens is currently undergoing a transformation as young villagers now rarely become reindeer herders, refusing to migrate with reindeer all-year round.

Reindeer herding practices are also changing, which results in shorter migration routes, fewer campsites, and camp moving less often. The Evens are simultaneously integrated into the Russian cultural space. All these external influences threaten the traditional Evens lifestyle. The Association of the Indigenous Peoples of the Sakha Republic (under the presidency of Andrey V. Krivoschapkin, Sebyan-Kyuel Village) is the main public organization uniting indigenous communities in the region.

The Project area can be regarded as having a high potential in terms of the use of its ecosystem services by the local communities. The most extensively used ecosystem services are in areas around Sebyan-Kyuel, along the winter road, and reindeer herders' migration routes. The most important ecosystem services are graze land resources extensively used by the local reindeer herders.

Other important land use in the area are hunting and fishing resources as one of the main sources of household incomes, and an important food source for the local communities. Hunting is predominantly commercial, the sable being the main game animal. OJSC FPK Sakhabult (private commercial enterprise of agricultural and industrial specialization, specializes on hunting and processing of fur) holds a commercial game hunting license with a wildlife management area (WMA) of 1,835 ha within the Project area (17% of the total area of Ulus). Fish caught in the local lakes and rivers are the second most important local source of food after reindeer meat. Residents of Sebyan-Kyuel mostly access fish on the lakes located east of the settlement. The locals also fish at the rivers, including the area near the former Endybal Village (the Arkachan River).

Timber resources are significant for the local communities as the majority of houses have stove heating. However, timber reserves are small in mountainous areas. Mature forests around settlements have essentially been cleared. Wild berries (bog whortleberry, cranberry, cowberry, currants, etc.), mushrooms (orange-cap boletus, orange agaric, yellow boletus, etc.) and medicinal herbs are gathered around the village primarily for personal consumption.

According to official information, no cultural heritage sites (of federal, republic, or local (municipal) significance) listed in the Russian National Uniform State Register of Cultural Heritage Sites or identified cultural heritage sites are located within the Project area. An archaeological survey was completed as part of the ethnological assessment during the summer of 2015. The survey confirmed an absence of any objects of cultural heritage within the Project site. Some sites of spiritual and religious value for the local community are located near Sebyan-Kyuel and the Project site. A shaman's grave (northwest of the Project) and ancestral burial sites (in the former Endybal Village) are located 10 to 15km from the Project. Some sites of worship (shaman's grave, ancestral graves, sacred trees) are located near the winter road and include these ancestral burial sites worshipped by individual families and the Evens worship graves of shamans and sacred natural sites.

### 20.3 Stakeholder Agreement

Major stakeholder groups connected with the Project were identified during the scoping stage of the Project. Table 20.2 includes the key groups of external and internal stakeholders. Activities undertaken as of June 2016 by SBR and its consultants have included public hearings in line with requirements of the RF regulations and informal consultations with local communities and authorities during the data collection in the course of the socio-economic study. Key interests and concerns identified by ERM that have been raised as of June 2016 through the stakeholder engagement include:

- Employment opportunities for young people from the village of Sebyan-Kuel that would reduce the outflow of young people in other settlements of Yakutia;
- Negative impact on traditional activities of the community of Sebyan-Kuel, mainly related to reindeer herding; and
- Overall effect to the health of reindeer herders, and the residents of SebyanKuel. ERM helped SBR establish formal stakeholder engagement procedures, including the development of internal and external grievance mechanisms. Prognoz signed an agreement for social and economic cooperation with administration of the Nasleg (municipality) and the Ulus (district) in March 2013. The agreements are aimed to cover the relationship between SBR and local administrations in the course of the exploration activities. In May 2016 these agreements were amended and extended to the term of construction stage.

The aim of such agreements is to define the size and/or form of financial and other assistances to local communities, the communication channels, tools of support distribution etc. Current agreement includes support local community to construct Cultural Center with provision construction materials and logistics, fuel delivery etc. As reported by the Company at the date of reporting all current obligations are performed by ZAO Prognoz in due time. No potential complaints from authorities or local community are expected by the Company with regard to implementation of these activities.

<b>Group</b>	<b>Stakeholders</b>
Indigenous people (Evens)	<ul style="list-style-type: none"> <li>Indigenous people whose reindeer herding camps and routes are located close to the Project site</li> </ul>
Residents of the settlements located near the Site and associated infrastructure facilities	<ul style="list-style-type: none"> <li>Residents of Sebyan-Koel, Segen-Koel and Batamay settlements</li> </ul>
Organizations and individuals whose property rights will be affected by temporary or permanent withdrawal of land plots during the Project implementation	<ul style="list-style-type: none"> <li>Enterprises of the Lamynkhinsky nasleg, that are located close to the Project site (mainly commercial hunting and herding groups, Sakha bult and SUE Sebyan)</li> </ul>
Government authorities and regulators	<ul style="list-style-type: none"> <li>Federal authorities Sakha Republic regional authorities; Local authorities (administrations of the Kobaysky ulus, Lamynkhisky and Kirovsky naslegs)</li> </ul>
Non-government organizations, independent experts	<ul style="list-style-type: none"> <li>Specialized environmental, public and research organizations, experts (Association of the Indigenous people of Sakha republic, etc.) Public organizations promoting social programs Other public organizations in the Project area</li> </ul>
Beneficiaries of SBR's social programmes	<ul style="list-style-type: none"> <li>Communities of Sebyan-Koel, Segen-Koel and Batamay settlements</li> </ul>
Mass media	<ul style="list-style-type: none"> <li>Local and regional internet recourses: Newspaper "Yakutiya" Local and regional internet recourses: <a href="http://www.ysia.ru">www.ysia.ru</a> <a href="http://www.sakhalife.ru">www.sakhalife.ru</a> <a href="http://www.gold.prime-tass.ru">www.gold.prime-tass.ru</a> <a href="http://www.vedomosti.ru">www.vedomosti.ru</a></li> </ul>
Personnel of SBR, Organizations involved into the Project implementation and subcontractors	<ul style="list-style-type: none"> <li>Construction and project organizations involved into the Project implementation Company's personnel and subcontractors' employees Consultants involved into the Project implementation</li> </ul>
Organizations involved into personnel training and selection	<ul style="list-style-type: none"> <li>Educational institutions on basis whereof training of personnel for the enterprise is realized Recruitment centers</li> </ul>

## **20.4 Environmental and Social Impact Assessment, Mitigation and Management Plans**

### **20.4.1 Environmental and Social Impact Assessment**

Consideration of environmental and social factors throughout the entire lifecycle of the Project (preparatory works, construction operations, production operations, and decommissioning) is an essential prerequisite to successful projects.

In order to meet both Russian and international requirements, the following must be undertaken as part of the impact assessment process:

- As required by Russian regulatory requirements, and based on a range of studies and surveys, SBR developed Russian design documentation including materials for an ESIA and an

environmental protection plan (EPP). At the time of preparation of this section SBR has completed development and received approval of that part of the Russian Design Documentation including materials of Environmental Impact Assessment and Environmental Protection Plan covering the mining and waste management sections. Russian Design Documentation for processing plant has also been approved by the regulatory authorities.

- ERM has developed international Environmental and Social Impact Assessment (ESIA) based on Feasibility Study as originally released. The ESIA was completed by ERM on behalf of SBR in July 2016. The Environmental and Social Management Plan (including specific MPs) to address the impact and issues identified by the ESIA were developed by ERM in August 2016. However it is recommended to perform the Gap Analysis of SBR’s performance against the IFC Performance standards based on recent Project’s updates and to develop an Environmental and Social Action Plan which will include steps to cover the gaps identified. Developing two sets of documents in accordance with Russian and international requirements is a common practice for Russian projects due to the different format and level of detail required by the Russian regulations, as compared to international community.

**20.4.2 Environmental and Social Management Plan**

Table 20.3 presents a summary of key identified environmental and socio-economic aspects of the local area and recommended mitigation measures and management for Project design and planning. Given that the project design development and construction activities are ongoing, there may also be additional mitigation and management measures under consideration to further reduce the negative effects during construction and operation, and to meet closure objectives.

<b>Aspect</b>	<b>Risk/Potential Impact</b>	<b>Mitigation &amp; Control Measures</b>
Geology	<ul style="list-style-type: none"> <li>ARD/ML from newly exposed rock surfaces, rock used for infrastructure construction, surface storage of waste rock and/or processed ore tailings, resulting in impacts to surface water sources; and</li> <li>Mobilization of fine particles by wind or water, potentially leading to increased amounts of dust in the air or deposition to area land and water.</li> </ul>	<ul style="list-style-type: none"> <li>Preliminary studies indicate that the waste rock and tailings generated by the Project will be NAG but will likely leach elevated concentrations of metals including zinc, lead, cadmium, silver, and arsenic and antimony. These parameters are also elevated in the existing surface water environment.</li> <li>Roads and pads used for infrastructure development will use surface and/or quarry rock designated as low risk for ARD/ML.</li> <li>Waste rock will be stored on surface in a dedicated facility. Seepage from the waste rock will be combined with contact water from the site and directed to an unlined exfiltration pond to remove suspended solids. Water quality will be monitored to confirm compliance with regulatory requirements for release to the environment.</li> <li>Tailings will be stored on surface as a filtered dry stack. The facility will be lined and during operations any excess water will be pumped from a clarification pond and directed to the process plant for recycling. The TMF will operate as a zero discharge facility during normal operations.</li> </ul>

**Table 20.3: Key Environmental and Socio-Economic Aspects**

Aspect	Risk/Potential Impact	Mitigation & Control Measures
		<ul style="list-style-type: none"> <li>Further testing of materials will be required to validate initial conclusions regarding the potential for ARD/ML. The feasibility study assumes that beyond the use of an exfiltration pond, downgradient of the WRD water treatment will not be required to protect the environment and meet regulatory requirements. Further work is required to validate this assumption.</li> </ul>
Ground Stability and Permafrost	<ul style="list-style-type: none"> <li>Siting and/or design of facilities results in permafrost degradation, ground stability, or other alterations of the active or inactive soil layers resulting in facility failures and impacts to the receiving environment.</li> </ul>	<ul style="list-style-type: none"> <li>A siting trade-off study was completed by SRK and geotechnical conditions were considered as part of this study. The TMF and WRD are located in areas covered with shallow, generally granular overburden, over sedimentary bedrock. The feasibility study concluded that the risk of soil subgrade instability is low.</li> </ul>
Groundwater	<ul style="list-style-type: none"> <li>Impacts to groundwater regime due to the use of water for mining and milling purposes.</li> </ul>	<ul style="list-style-type: none"> <li>A water sourcing study was completed by SRK others and concluded that sufficient groundwater is available to support Project demands. Drawdown of the deep aquifer is not expected to result in unacceptable impacts to the natural environment and there are no other users of this water. Mining occurs within the zone of permafrost and is not expected to have a material impact the groundwater regime.</li> </ul>
Surface Water Quality	<ul style="list-style-type: none"> <li>Impacts to the water quality in the Sirelendge River and/or its tributaries due to the physical disturbance to river sediments, discharge of treated sewage, seepage of water with elevated TSS and/or metals from the exfiltration pond downgradient of the WRD and runoff from project infrastructure. Deposition of dust to water bodies from use of roads and from the dry stack TMF.</li> <li>Spills to surface water bodies from hydrocarbon storage and transport.</li> </ul>	<ul style="list-style-type: none"> <li>The general site arrangement for the Project site was designed to protect surface water quality by directing contact water through a series of runoff collection ditches to a seepage and runoff collection pond adjacent to the northeast boundary of the WRD. This pond will act as a sediment control pond allowing sediment to settle out prior to release of excess water to the receiving environment. Sewage from the camp site will be treated and trucked to the TMF. Monitoring of site discharges and of the receiving environment will be undertaken to confirm the effectiveness of controls.</li> <li>The feasibility study assumes that water content and weather conditions will suppress dust from the TMF. This assumption will be validated through site monitoring and further mitigation, including the use of dust suppressants, if necessary.</li> </ul>
Hydrology	<ul style="list-style-type: none"> <li>Disruption of the natural flow patterns of surface runoff to Sirelendge River and its tributaries due to the Project footprint resulting in a loss of drainage and potential impacts to the aquatic environment.</li> <li>Impacts to the surface water environment due to loss of</li> </ul>	<ul style="list-style-type: none"> <li>Compact project footprint located at the headwaters of the drainage basins for the Porfirovy Creek and the Borisovsky Creek. The main project infrastructure intersects approximately 13% and 4%, respectively, of the total catchment area for these tributaries and 0.51% for the Sirelendge River.</li> <li>Potential reduction in flows considered minor. Hydrological monitoring should be conducted during operations to confirm the impacts to the aquatic environment are not occurring.</li> </ul>

**Table 20.3: Key Environmental and Socio-Economic Aspects**

Aspect	Risk/Potential Impact	Mitigation & Control Measures
	water to the open pit or underground mine workings.	<ul style="list-style-type: none"> <li>Mining is contained entirely within the zone of continuous permafrost. All zones of mining are above the invert elevations of the local creeks and the Sirelendge River. Excess contact water that collects in the pit and underground workings (precipitation and drill water) will be collected in sumps and pumped to the exfiltration pond adjacent to the WRD.</li> </ul>
Aquatic Life (Including fish and fish habitat)	<ul style="list-style-type: none"> <li>Project activities directly removing or altering fish habitat (e.g. culvert installations and reduction in stream flows below normal low levels).</li> <li>Project activities potentially affecting water quality or sediment quality.</li> </ul>	<ul style="list-style-type: none"> <li>No direct impacts to fish and fish habitat are expected as a result of Project infrastructure. Any discharges to the receiving environment will meet regulatory discharge criteria and the receiving environment will be monitored.</li> </ul>
Terrestrial Ecosystem	<ul style="list-style-type: none"> <li>Loss of ecosystems and vegetation to footprint of Project and supporting infrastructure.</li> <li>Degradation of ecosystems and vegetation through increased dust deposition, potential introduction of invasive plants, alteration of local hydrology, and effects caused by chemical spills.</li> </ul>	<ul style="list-style-type: none"> <li>Compact project footprint that directly impacts approximately 637 ha of terrestrial habitat. Use of a seasonal road for resupply purposes to reduce impacts to the terrestrial environment, protected plant species identified in the Project area will require special measures that may include protection zones, replanting programs and education and awareness programs. There are also unique ecosystems to the area that will need similar special measures.</li> <li>Standard operating procedures, such as restricting travel to authorized areas, dust control, spill response planning, and vehicle washing will reduce operational level impacts to the terrestrial environment.</li> </ul>
Terrestrial Wildlife	<ul style="list-style-type: none"> <li>Habitat loss (direct and indirect).</li> <li>Changes in movements and/or behaviours.</li> <li>Mortality (direct and indirect).</li> <li>Attraction of animals to human use sites.</li> </ul>	<ul style="list-style-type: none"> <li>Compact project footprint that directly impacts approximately 637ha of terrestrial habitat. Use of a seasonal road for resupply purposes to reduce impacts to the terrestrial environment.</li> <li>Loss of grazing and migration areas for reindeer will be offset through a compensation agreement with affected herders.</li> <li>Standard operating procedures, such as restricting travel to authorized areas, restricted speed limits on travel, avoiding nesting areas, and effective domestic waste management will reduce operational level impacts to local wildlife.</li> </ul>
Air Quality and Noise	<ul style="list-style-type: none"> <li>Airborne particulates</li> <li>Sulphur dioxide</li> <li>Nitrogen oxide</li> <li>Fugitive dust</li> <li>VOCs</li> <li>GHGs</li> <li>Diesel engine exhaust from vehicles.</li> </ul>	<ul style="list-style-type: none"> <li>Increased dust emissions (with elevated lead and arsenic) due to drilling, mining, processing activities (loading, crushing, grinding) and road traffic are the primary sources of air emissions. Installation of dust control and collection systems (e.g. reagent mixing, grinding) in the processing plant and standard operating procedures, such as restricting travel to authorized areas, speed control, and road watering to control dust along roadways. Use of modern equipment and standard operating procedures for the efficient use of fuel will minimize emissions such as</li> </ul>

**Table 20.3: Key Environmental and Socio-Economic Aspects**

Aspect	Risk/Potential Impact	Mitigation & Control Measures
		mono-nitrogen oxides. Equipment designed to Russian design standards to reduce noise to acceptable levels.
Climate	<ul style="list-style-type: none"> <li>• Employment and income opportunities, as well as other issues.</li> <li>• Education, training, and skills development opportunities.</li> <li>• Business opportunities and economic development.</li> <li>• Indigenous community stability and well-being impacts.</li> <li>• Loss of livelihoods and income of indigenous people due to loss of reindeer grazing areas.</li> </ul>	<ul style="list-style-type: none"> <li>• Establishment of socio-economic management plan that includes the following measures:               <ul style="list-style-type: none"> <li>– Project recruitment, employment and training plan to maximize local employment</li> <li>– Cooperation programs with central and local educational institutions; on-the-job training programs</li> <li>– Local content and procurement plan to maximize business and economic opportunities</li> <li>– Livelihoods restoration plan including establishment and distribution of a compensation fund to offset the Project impact and regular communications with the local herders and indigenous communities</li> <li>– Community development program.</li> </ul> </li> </ul>

Note: TSS – total suspended solids; VOG – volatile organic compound; GHG – greenhouse gas

## 20.5 Water and Waste Management

This section briefly describes the interaction of the Project with the environment during the operations phase, as it specifically relates to the management of water and wastes based on the current design of the facilities described in other sections of the feasibility study.

### 20.5.1 Water Management

#### 20.5.1.1 Water Supply

Water supply is provided from a groundwater well located in the Sirelendge River valley next to the camp. From a storage tank at the pump station, the raw water supply will be pumped via a 4.5-km pipeline to the raw water tank located at the processing facility. The pipeline between the pump station and the mill will be routed up the Borisovsky Valley and along the ridge to the west of the road. There are no other users of ground water in the area and work completed by NSI (2016) has concluded that no material environmental impacts are expected from the use of this water. During construction, water supply will be extracted from the Sirelendge River and trucked to the camp and process plant until the pump station and pipeline are available to provide the water supply.

#### 20.5.1.2 Site Contact Water

The general site arrangement for the Project has been designed to protect surface water quality by directing contact water through a series of runoff collection ditches to a seepage and runoff collection pond adjacent to the northeast boundary of the WRD. This pond will act as a sediment control pond allowing sediment to settle out prior to release of excess water to the receiving environment



(Borisovsky Creek). Contact water in the open pit and underground mine workings is anticipated to be limited to drill waste water and precipitation, as these operations are within continuous permafrost conditions and no groundwater inflow is expected. This contact water will collect in sumps for reuse in drilling if feasible, or pumped to the seepage and runoff collection pond adjacent to the WRD.

The current water balance developed for the Project should be expanded to include site-wide surface water sources, including contact water that collects in the seepage pond, water from the TMF, and open pit and underground mine water. This water balance should be developed to characterize both the quality and quantity of water that will be managed site wide. The current model was not used to predict water quality. The water balance should be used in conjunction with a site-wide water monitoring program to validate model predictions and confirm that environmental mitigation measures are effective and discharge can occur in accordance with anticipated permit conditions without further treatment.

## **20.5.2 Tailings and Waste Management**

### *20.5.2.1 Solid Waste and Sewage*

Solid waste is stored in the solid waste storage facility, located to the west of the processing plant. The solid waste storage facility is lined and segregated to handle different waste streams.

A sewage treatment plant is located at the camp to accommodate the camp and sewage trucked from the processing plant washroom facilities. Treated waste water trucked to the TMF and the solid sludge from the sewage treatment plant trucked to the TMF and stored with the tails.

### *20.5.2.2 Geochemistry of Waste Rock and Tailings*

To date, the characterization of the waste bedrock and saprolite has been undertaken by ERM on a limited number of samples and incorporates testing to classify solid material based on parameters that leach from the material (ERM 2016b).

Static acid-base accounting methods indicate that the NP is in excess of the acid AGP due to the elevated carbonate and low-sulphur content for most of the waste rock and tailings. In accordance with the assessment of AGP and geochemical characteristics of waste rocks, the elements with high concentrations in waste rock are zinc, lead, cadmium, silver, arsenic, and antimony. A wide range of elements characterized by high concentrations were found in aqueous extractions that simulate expected waste rock drainage. Concentrations of the following elements may potentially exceed the MPC established under Russian law: sulphate ion, magnesium, iron, aluminium, zinc, selenium, thallium (1.1 to 13.0 MPC), manganese, cadmium (1.1 to 140.0 MPC). However, the levels appear to be generally within the hydrochemical background levels found in the Project area. Acceptable water quality for discharge will be further confirmed with the authorities when SBR applies for the discharge permit. The feasibility study does not include an allowance for active treatment of seepage waters from the waste rock or tailings waste.

### 20.5.2.3 Waste Rock Dump and Overburden Stockpiles

The open pit will have a dedicated WRD and overburden stockpile during construction and operation. The waste material consists of waste bedrock and waste saprolite. Further information on the stockpiles, including the associated peripheral and internal drainage systems are provided in Section 18.10.

### 20.5.2.4 Tailings

The whole tailings generated in the process plant will be discharged into the TMF. The TMF will be constructed 0.2 km northeast of the process complex and will cover an area of 7.69 ha, storing approximately 0.8 Mt of dry (85% w/w) tailings material over the 7.4-year LOM. The dry waste storage area will consist of a HDPE lined pad surrounded by a rock fill perimeter berm. There will be a clarification pond at the eastern toe of the TMF waste stack with associated perimeter containment dam. During construction and operation phases, and under normal conditions, the TMF will be a zero discharge facility. Seepage will be diverted to the process plant after the clarification pond. Details on the TMF design are provided in Section 18.9. This design results in a low risk to the receiving surface water environment during normal operations.

## 20.6 ERM Comments

The feasibility study update for the Project is based on a revised mine plan to reflect the results of a more recent drilling program conducted at the property. ERM has updated its summary of the environmental, social, and regulatory factors on an assumption that no material changes regarding the interaction between the Project and the natural and social environments are introduced with the revised mine plan. As such, the original review of environmental and social factors completed by ERM is considered to remain accurate. The contents of this section have been updated from the Feasibility Study technical report released in June 2016 based on verbal updates provided by the company only.

Regulatory approval documents, where received, were not available for ERM review as part of this update. ERM provides the following overarching comments and recommendations.

- Project documentation required for the Russian regulatory review and approval process has been developed in parallel with completion of the FS and an ESIA in accordance with international standards has been initiated but is incomplete. The assessment of potential effects of the Project, the development of mitigating and management measures, and the establishment of monitoring programs embedded in the feasibility study are considered to be preliminary and are expected to evolve over time. The results of ongoing work, including ongoing environmental studies, stakeholder engagement, and permitting have the potential to influence the design, operations, and economic results of the Project.
- The State Environmental Review was completed and approved after the effective date of the updated FS. As such, the FS does not consider the impact any terms and conditions associated with this approval may have on the Project and its design. ERM has not completed a gap

assessment of the FS Project and the requirements associated with the State Environmental Review.

- The State Environmental Review was completed prior to the updated FS based on an optimized mine plan. ERM recommends that SBR confirm with the regulatory authorities if an amendment to the approval is required.
- Project level socio-economic framework agreements have been negotiated with local stakeholders to mitigate potential socio-economic impacts of the Project. Cost estimation of social investments will be defined on the basis of annual consultations with authorities... ERM has not reviewed any cost allowances associated with these agreements that may have been included in the financial analysis of the Project presented in Section 21. Environmental and social cost allowances were provided by SBR to Tetra Tech.
- Further engagement with local indigenous communities with regard to land and resources restoration is recommended to ensure that social requirements of the IFC Performance Standards are met.
- Further environmental studies are recommended to enhance the dataset characterizing the aquatic environment and confirm the source of elevated metals found in the local and regional waterways, including the potential impact of exploration and development activities that have already taken place. These studies should be used to inform the permitting process and to validate the effectiveness of environmental controls planned to protect the receiving environment.
- Vehicular travel adjacent to, and within the bed of, the Sirelendge River and its tributaries can present a risk to water quality and fish and fish habitat and is not in accordance with good international practice for environmental protection. The current plans also present a permitting risk with Russian authorities.
- The current water balance developed for the Project should be expanded to include site-wide surface water sources, including contact water that collects in the seepage pond, water from the TMF, and open pit and underground mine water. This water balance should be developed to characterize both the quality and quantity of water that will be managed site wide. The current model was not used to predict water quality. The water balance should be used in conjunction with a site-wide water monitoring program to validate model predictions and confirm that environmental mitigation measures are effective and discharge can occur in accordance with anticipated permit conditions without further treatment.
- During normal operations, the TMF will operate as a zero discharge facility; however, further study should be undertaken to define the conditions under which discharge to the environment is possible to assess the acceptability of this discharge. Further characterization of the tailings material and the potential for ARD/ML is required. The ARD/ML work completed to date is preliminary.
- A seepage and surface runoff collection pond will be constructed down gradient of the WRD that will act as a sediment control pond allowing settling of suspended solids prior to releasing water to be released to the environment. Further study is recommended to characterize the predicted quality and quantity of this waste water to confirm the assumed acceptability of release without additional management or treatment. This study should include further characterization of the waste rock that will be generated by the project and confirm that no

further mitigation is required to protect the environment during operations and closure phases. The feasibility study does not currently include an allowance for further treatment of seepage that is released from this pond.

- The establishment of more detailed management and monitoring programs will need to be designed and implemented to support construction, operations, and closure phases of the project. Current plans are conceptual in nature. Potential costs associated with the implementation of these programs have been included as an allowance as part of the G&A costs. ERM has not evaluated these costs and has not commented on their adequacy.
- The existing planning for closure and reclamation (as presented by others) is currently at a conceptual stage. Further planning and costing is required to support future stages of the Project and validate the assumptions made in the study. Emphasis should be placed on defining the required technical studies needed to inform the evolution of the closure and reclamation plan over the life of the Project such that the end goals are met. Particular attention should be placed on infrastructure decommissioning, the closure of waste facilities and the management of water post closure, including the potential need for water treatment.

## 20.7 WAI Evaluation

WAI considers that this chapter has addressed, where applicable, environmental and social sensitivities identified by ERM (ESIA, July 2016) that may be impacted by the Project and require management and monitoring (ERM ESMP, August 2016) during operation and mine closure.

Consequent to the Project's recent update, Tetra Tech identified requirements to meet Russian regulatory requirements, as well as the need to conduct a gap analysis to assist with ensuring that IFC Performance Standards will be addressed through the implementation of an Environmental and Social Action Plan.

Whilst the baseline conditions associated with the Project have not altered in terms of the extent of affects to social and environmental sensitivities that may arise from the Project, the review has identified the requirement for ongoing environmental investigations and review as a component of environmental and social management.

In this regard, the need for further ARD/ML testing, which is consequent to the recognition that previous ARD/ML studies, for both tailings and waste rock were preliminary only and required ongoing study; the need to update and verify water balance studies through monitoring; the requirement to implement an environmental monitoring programme; and the need for further studies relating to the development of a mine closure plan, both in terms of the environmental restoration of the site as well as a community development programme where livelihoods may or will have been affected by the Project. Further, it addresses ongoing permitting requirements and the requirement for ongoing dialogue with the statutory authorities.

## 21 CAPITAL AND OPERATING COST DEVELOPMENT

Capital and operating costs reported in this section in US Dollars are shown in 2019 US Dollars. These costs assumptions have been used in the preliminary economic assessment with appropriate inflation rates being applied. Therefore, costs reported in this section appear different to the costs shown in the Financial Analysis Section.

### 21.1 Mining - Introduction

A mining cost model was developed to assess the open pit and underground mining capital and operating expenditures for the Mangazeisky Project. The combined open pit and underground production schedule was used as the basis for cost estimation. The cost estimates were developed by WAI based on data provided by SBR and WAI's internal cost database.

The calculated costs are estimated to have an accuracy equivalent to a Preliminary Economic Assessment (PEA) level of detail. The study offers a valuable view in determining the merits of pursuing further engineering studies but should not be the sole reference for the purposes of economic decision making.

### 21.2 Open Pit Costs

#### 21.2.1 Capital Cost Estimates

Open pit capital costs were estimated based on WAI's cost database and project experience of similar operations.

No equipment capital costs were considered for the open pit operations. It is assumed that additional equipment for drill & blasting, load & haul will be leased as detailed in Table 21.1. This table assumes only the primary equipment used in earthmoving will be leased for D&B, L&H from major suppliers. It is not ordinarily cost effective for such suppliers to lease support and auxiliary equipment. Overhaul costs for the existing primary equipment (i.e., production drills, loaders and haul trucks) were scheduled at 50% of the equipment operating life and costed at 40% of the initial equipment purchase price. Overhaul costs are estimated to be in the region of US\$1.23M.

Provision was made for the construction of various access routes for pit development and material transport. A summary of these routes is provided below:

- Vertikalny Pit 1 Cut & Fill road
- Mangazeisky North Cut & Fill road
- Vertikalny to Mangazeisky North connecting road - *Approximately 7.8km long dirt road with a planned width of 16m.*

Cut & Fill road costs were based on the anticipated average mining cost, less the costs of drilling and blasting. Costs to develop the connecting road are based on rates from similar projects. A summary of the capital costs required for the preparation of these access routes is provided in Table 21.2.

	Cost of equipment (incl. VAT)	Interest on Leasing	Currency	Years	Months
Drill Rig Flexi Rock D60	56,776,534	8,023,273	RUB	2.00	24
Excavator CAT 374FL	730,000	105,876	USD	3.00	36
Dump Truck CAT 740GC	586,400	85,049	USD	3.00	36
Dump Truck CAT 740GC	586,400	85,049	USD	3.00	36
Dump Truck CAT 740GC	586,400	85,049	USD	3.00	36
Dump Truck SCANIA G440	12,340,000	1,670,840	RUB	1.25	15
Dump Truck SCANIA G440	12,340,000	1,670,840	RUB	1.25	15
Dump Truck SCANIA G440	12,340,000	1,670,840	RUB	1.25	15
Dump Truck SCANIA G440	12,340,000	1,670,840	RUB	1.25	15
Dump Truck SCANIA G440	12,340,000	334,168	RUB	0.25	3
Dump Truck SCANIA G440	12,340,000	334,168	RUB	0.25	3
Dump Truck SCANIA G440	12,340,000	334,168	RUB	0.25	3
Dump Truck SCANIA G440	12,340,000	334,168	RUB	0.25	3
<b>Total Rubles</b>	<b>157,323,618</b>	<b>16,231,814</b>	RUB		
<b>Total USD</b>	<b>2,501,554</b>	<b>362,815</b>	USD		
<b>Total in USD</b>	<b>4,699,680</b>	<b>590,195</b>	USD		

ITEM	TOTAL COST (US\$ 000's)
Vertikalny Pit 1 CAF road	575
Mangazeisky North CAF road	598
Vertikalny – Mangazeisky North connecting road	123
<b>TOTAL</b>	<b>1,300</b>

### 21.2.2 Operating Cost Estimates

Open pit operating costs were estimated by WAI based on the generated production schedule, equipment operating cost estimates, consumable price estimates and labour estimates.

The operating costs were estimated on a per tonne of rock mined basis and broken down by operational activity. A summary of the overall open pit operating costs by centre is provided in Table 21.3.

WAI notes that additional equipment required to carry out the production schedule (Section 16.9.3) are treated as leased. Operating costs for these additional items of equipment include a mark-up factor of 25% to account for leasing, resulting in approximately 1.4% of the total operating unit costs shown in the table above.

<b>COST CENTRE</b>	<b>UNIT</b>	<b>COST</b>	<b>SPLIT</b>
Hauling	US\$/t	0.61	28%
Blasting (Contractor)	US\$/t	0.46	21%
Drilling	US\$/t	0.39	18%
Loading & Stockpiling	US\$/t	0.34	16%
General Mine Maintenance	US\$/t	0.12	6%
Dozing & Grading	US\$/t	0.12	5%
Engineering/Geology	US\$/t	0.05	2%
Supervision & Technical	US\$/t	0.05	2%
Other	US\$/t	0.04	2%
<b>TOTALS</b>	<b>US\$/t<sub>MOVED</sub></b>	<b>2.17</b>	<b>100%</b>
	<b>US\$/t<sub>ORE</sub></b>	<b>53.88</b>	
	<b>US\$/t<sub>WASTE</sub></b>	<b>2.27</b>	

Estimated overall open pit costs are in the region of US\$2.17/t rock mined. Any costs not associated with mining activities are included in the financial analysis.

## 21.3 Underground Costs

### 21.3.1 Capital Costs

Underground capital costs were estimated based on WAI's cost database and project experience of similar operations. Estimated capital costs include mine development and mine equipment.

Mine development capital is inclusive of any mine development that is capitalised. The cost estimates are based on the completed mine designs and WAI's cost database. A summary of the mine development categories, unit costs and cost allocation are provided in Table 21.4.

<b>ITEM</b>	<b>UNIT COST (US\$/m)</b>	<b>COST ALLOCATION</b>
Access Decline	472	CAPEX
Level Access Drive	432	CAPEX
Ventilation Drive	432	CAPEX
Remuck Bay	694	CAPEX
Ventilation Raise	26	CAPEX
On-Vein Drive	433	OPEX

Equipment capital costs include the purchase of new equipment, initial spare parts inventory and sustaining capital for equipment overhaul. Overhauls were scheduled at 50% of the equipment operating life and costed at 40% of the initial equipment purchase price. Given the relatively short life of the underground operations, equipment overhauls were favoured over new equipment purchases.

A breakdown of the total capital costs incurred over the life of the underground project is provided in Table 21.5.

ITEM	PRE-PROD (US\$ 000's)	LOM (US\$ 000's)	TOTAL (US\$ 000's)
Capitalised Development	0.844	3.47	<b>4.31</b>
Mine Equipment - Purchase	10.12	6.08	<b>19.02</b>
Mine Equipment – Sustaining (Overhaul)	-	2.62	
Mine Equipment – First Fill & Spares (2%)	0.20	-	
<b>TOTAL</b>	<b>11.16</b>	<b>12.17</b>	<b>23.33</b>

A breakdown of the pre-production capital equipment purchase for the project is provided in Table 21.6.

ITEM	UNIT COST (US\$ 000's)	QTY	TOTAL COST (US\$ 000's)
Development Jumbo – Single Boom	563	2	1,126
Load Haul Dump – 1.5m <sup>3</sup>	373	2	745
Underground Haul Truck – 20t	720	2	1,440
Explosives Truck	576	1	576
Small Motor Grader	288	1	288
Fuel & Lube Truck	576	1	576
Water Truck (Dust Suppression)	576	1	576
Underground 4x4	48	6	286
Scissor Lift	350	1	350
Primary Fan	750	4	3,000
Auxiliary Equipment, including: Secondary Fans & Starters Compressors Main Pump Face Pump Jumbo Boxes	-	-	1,158
First Fill & Initial Spares	-	-	202
<b>TOTAL PRE-PRODUCTION CAPEX</b>	<b>-</b>	<b>-</b>	<b>10,323</b>

### **21.3.2 Operating Cost Estimate**

Mining operating costs were estimated by WAI, based on the mine designs, equipment operating cost estimates, consumable price estimates and labour estimates. A summary of the overall underground operating costs is provided in Table 21.7.

WAI notes that raise boring equipment was treated as leased in this study due to the high purchase price, life of the operation and anticipated workload. Operating costs for raise-boring include a mark-up factor of 50% to account for leasing. Overall underground mining costs are estimated to be in the region of US\$40.56/t ore mined. Any costs not associated with mining activities are included in the financial analysis.



<b>Table 21.7: Underground Operating Cost Summary</b>			
<b>ITEM</b>	<b>UNIT</b>	<b>TOTAL COST</b>	<b>SPLIT</b>
Operating Development	US\$M	5.18	15%
Operating Expenditure	US\$M	19.73	58%
Personnel Salaries	US\$M	9.17	27%
<b>TOTAL OPEX</b>	<b>US\$M</b>	<b>34.08</b>	<b>100%</b>
	<b>US\$/t<sub>ORE</sub></b>	<b>40.56</b>	

## 21.4 Processing Costs

### 21.4.1 Capital Costs

SBR provided a capital cost estimate for the proposed primary sulphide flowsheet of RUB 1,156,061,000 (approximately **US\$17.3M**). This is considered reasonable for an approximate 500tpd operation. However, this is based on a new plant, independent from the current oxide plant. This may be required if it is desired to process both oxide ore and sulphide ore simultaneously. If the sulphide ore is to be processed after exhaustion of the oxide ores, then the capital cost can be significantly reduced by utilising most of the current installed equipment. In this case, the capital cost is estimated at approximately **US\$9M** with the requirement for the new flotation circuit and additional crushing and grinding capacity. An additional cost of **US\$2M** has been estimated to install a new XRT system on site.

### 21.4.2 Operating Costs

Table 21.8 provides summary of the Project processing costs:

<b>Table 21.8: Project Processing Opex Summary</b>		
Ore Sorting Cost	US\$ /t	2.25
<b>Leach Plant (Current Plant)</b>		
Unit Processing Cost (Oxides)	US\$ /t	72.95
Unit Processing Cost (Sulphides)	US\$ /t	123.71
<b>Flotation Plant (New Plant)</b>		
Unit Processing Cost (Sulphides)	US\$ /t	47.18

The process operating cost has been estimated by SBR as **US\$47.18/t**, based on the flotation testwork results and reagent consumptions, and is considered reasonable for use in the pit optimisation studies. This compares with the Tetra Tech design operating cost of **US\$121.8/t** based on using the existing oxide plant, but with the modifications for finer grinding and additional leach residence time, with US\$85.4/t contributed by the increased reagent consumptions (lime and cyanide in particular).

## 22 FINANCIAL ANALYSIS

### 22.1 Overview

WAI has undertaken a preliminary economic assessment of the Mangazeisky Project, using Discounted Cash Flow (DCF) analysis, from which the Net Present Value (NPV), payback period and other measures of project viability have been determined.

The financial analysis has been performed to reflect valuation as of the end of 2019 and does not include any sunk costs that have already been invested in the project.

The Project Internal Rate of Return (IRR) cannot be estimated due to more than one occurrence of the negative cash flows during the project life: initially at the end of 2019 and secondly in 2021. Despite current production relative stability, occurrence of the negative cash flows in 2021 is explained by additional capital expenditures required for completion of the new flotation plant construction, and production shortfall caused by transition from oxide ore to the sulphides.

The Project Financial Model (“Model”) has been developed using the production schedule developed by WAI, with all costs being estimated in 2019 US Dollars based on the actual production data and available databases.

Forecasted fluctuating US Dollar (US\$) and Ruble inflation rates have been applied appropriately to both commodity prices and project costs to provide financial results in nominal values.

All costs and cash flows reported in this section are shown in nominal US Dollars after inflation has been incorporated (unless stated otherwise), therefore costs appear different to the costs reported in the engineering sections above.

Summary of key input assumptions is outlined below.

### 22.2 Metal Prices

The main products from the Mangazeisky Project are proposed to be silver bullion and two concentrates: silver bearing zinc concentrate and silver bearing lead concentrate.

Price forecast as of 2019 has been used as the basis for the project assessment, with an appropriate inflation rate being included in valuation.

<b>Scenarios</b>	<b>Price Assumption (as of 2019)</b>
Ag (US\$ / oz)	17.76
Pb (US\$ / t)	2,069
Zn (US\$ / t)	2,252

## 22.3 Macroeconomic Parameters

The financial model has been developed using the macroeconomic parameters shown in Table 22.2.

Table 22.2: Macroeconomic Assumptions								
Period	Y1 Q4	Y2	Y3	Y4	Y5	Y6	Y7	Y8
Year	2019	2020F	2021F	2022F	2023F	2024F	2025F	2026F
RUB/USD	64.7	72.1	70.0	70.0	70.0	71.4	72.8	74.2
Annual Inflation for RUB	0.00%	4.70%	4.00%	4.00%	4.00%	4.00%	4.00%	4.00%
Estimated Cumulative - RUB		4.78%	9.80%	15.05%	19.65%	24.44%	29.41%	34.59%
Long Term Inflation USD	0.50%	2.00%	2.00%	2.00%	2.00%	2.00%	2.00%	2.00%
Estimated Cumulative Inflation USD		2.00%	4.04%	6.12%	8.24%	10.41%	12.62%	14.87%

Data on exchange rates and Ruble inflation is used as per the SBR's corporate forecasts. US Dollar inflation rate applied as per WAI assumption.

## 22.4 Payment & Realisation Terms

Realisation terms for silver have been provided by the Client based on the actual data and products assumed to be sold to a smelter located in Kazakhstan. A summary of assumptions on lead and zinc concentrates payment terms is presented in Table 22.3.

Due to the limited data on impurities contained in concentrates, no penalties have been included in this valuation and that low lead grade assumptions in the concentrates will be offset by high silver grades.

Table 22.3: Project Payment Terms		
<b>Assay Payable</b>		
Silver Net Assay Payable	%	98.00%
Pb and Ag Payable in Lead Concentrate	%	84.00%
Zn and Ag Payable in Zinc Concentrate	%	45.00%
<b>Selling and Realisation</b>		
Ag Selling Cost	US\$/oz	0.4
Concentrate delivery and transportation	US\$/wmt	274.9
Moisture Content	%	8%
Pb in Pb Concentrate	%	17.1%
Zn in Zn Concentrate	%	42.3%

WAI notes that concentrate treatment charges are considered to be covered by the payment terms outlined in the table above.

## 22.5 Processing Recovery Rates and Production Summary

Summary of the overall processing recovery rates and recovered metals is shown in Table 22.4.

<b>Table 22.4: Summary of the Project Processing Recovery and Metals Production</b>				
<b>Metals</b>	<b>Total Processing Recovery</b>	<b>Units</b>	<b>Mined</b>	<b>Recovered</b>
Silver	82.47%	oz '000	26,774	22,081
Lead	68.81%	t	44,948	30,929
Zinc	94.09%	t	17,969	16,908

## 22.6 Capital Costs

Overall capital cost for the project have been estimated at US\$43M. Summary of the Project Capital Cost is shown in Table 22.5.

<b>Table 22.5: Project Capital Costs Summary (US\$M, nominal total for the LOM)</b>	
<b>Total Project Capital Costs, including</b>	<b>43</b>
Mining Capex for Open Pit	2.5
Mining Capex for Underground	24.6
Leasing of Mining Equipment – Principal Repayment	4.7
Processing Plant Cost: Upgraded XRT and Flotation Plant VS New Plant	11.2

No plant sustaining cost or TSF costs have been included at this stage of valuation. WAI has also considered that all general infrastructure is already in place.

## 22.7 Operating Costs

The overall operating cost has been estimated at US\$242.7M (nominal values). Summary of the costs is provided in Table 22.6.

<b>Table 22.6: Less Operating Costs (US\$M, nominal values)</b>	
Mining Cost	82.3
Plant Processing Cost	68.3
G&A	46.7
Mining Royalty (Mineral Extraction Tax)	45.0
<b>Total Operating Cost LOM</b>	<b>242.7</b>

Payments to reclamation and closure fund, total of US\$4.2M payable in the last project year have been included into the financial model as provided by the Client.

## 22.8 Tax Regime

WAI has developed a post cash flow model where the tax regime shown in Table 22.7 has been implemented.

Carried forward losses from previous periods in the amount of CAD6.9m (as per IFRS data) or US\$5.3M have been incorporated in the model for tax purposes.

<b>Table 22.7: Project Tax Summary</b>		
	<b>Rate</b>	<b>Total (US\$M, nominal)</b>
MET: Silver	6.5%	33.31
MET: Lead	8.0%	8.12
MET: Zinc	8.0%	3.57
Corporate Income Tax	20%	8.2

No VAT rebate has been considered in the financial model.

## 22.9 Financial Summary

Project financial summary is presented in Table 22.8 and Table 22.9.

<b>Table 22.8: Key Project Technical and Economic Indicators</b>	
<b>Gross Revenue</b>	449
Less Realisation Costs	81
<b>Net Revenue</b>	368
<b>Less Operating Costs</b>	
Less Mining Cost	82.3
Less Plant Processing Cost	68.7
Less G&A	46.7
Less Mining Royalty Tax	45.0
<b>Total Operating Cost LOM</b>	<b>242.7</b>
<b>EBITDA</b>	125.5
Less Interest Cost (Leasing)	0.6
Less Depreciation & Amortisation	100.4
Less Payments to Reclamation Fund	4.2
<b>EBT</b>	20.3
Less Income Tax	8.2
<b>Net Income</b>	12
Plus Depreciation & Amortisation	100
Less Increase in Net Working Capital	0
<b>Cash Flow from Operations</b>	112
<b>Less Capital Costs, including</b>	43.0
Mining Capex for Open Pit	2.5
Mining Capex for Underground	24.6
Equipment Leasing	4.7
Processing Plant Upgrade Capital Cost	11.2
<b>Pre-Tax Cash Flow</b>	78
<b>Post Tax Free Cash Flow</b>	69

<b>Table 22.9: Financial Project Summary</b>		
NPV @ Discount Rate of 8.64%	US\$ M	<b>46.51</b>
Ag Break-even price	US\$/oz	14.11
NPV @ Discount Rate of 10%	US\$ M	43.87
NPV @ Discount Rate of 15%	US\$ M	35.77
NPV @ Discount Rate of 20%	US\$ M	29.60
IRR	%	<b>N/A</b>
Payback period of capital (Discounted, Cumulative)	date	<b>Q3 2021</b>

The results from preliminary economic assessment show positive NPVs at various discount rates. Break-even silver price was estimated at US\$14.11/oz which is 21% lower than the base case price assumption.

*Current financial results have been derived from the production schedule that considers oxide material from stockpile No 5, in the amount of approximately 50kt.*

*An additional upside scenario with revised lead concentrate yield at 5% and upgraded lead concentrate quality to 66% resulted in improved economics with NPV at \$58.7M at 8.64%. Although greater definition of concentrate products and other variables will be required to accept these concepts.*

## 22.10 Sensitivity Analysis

A sensitivity analysis was performed on the key parameters within the financial model to assess the impact of changes upon the Net Present Value of the project (at a base case 8.64% discount rate). These parameters are as follows: metal prices; operating costs and capital costs. Each factor was varied within a range of +/-40% (while other parameters remained unchanged) to examine the sensitivity of the model to changing economic and operational conditions.

Sensitivity analysis results show that the Project is mostly sensitive to change in Ag price, as it forms the major part of the project revenue and production costs (mining and processing), and less sensitive to changes in the lead and zinc prices.

The Project is also significantly sensitive to mining operating costs (both OP and UG), and relatively less sensitive to processing operating costs.

Considering relatively low proportion of the remaining capital costs, the Project is seen to be least sensitive to changes in capex. No sunk costs have been included in this analysis and major part of the capex is considered to be already invested.

The results are shown in Table 22.10 and presented in Charts below (Figure 22.1).

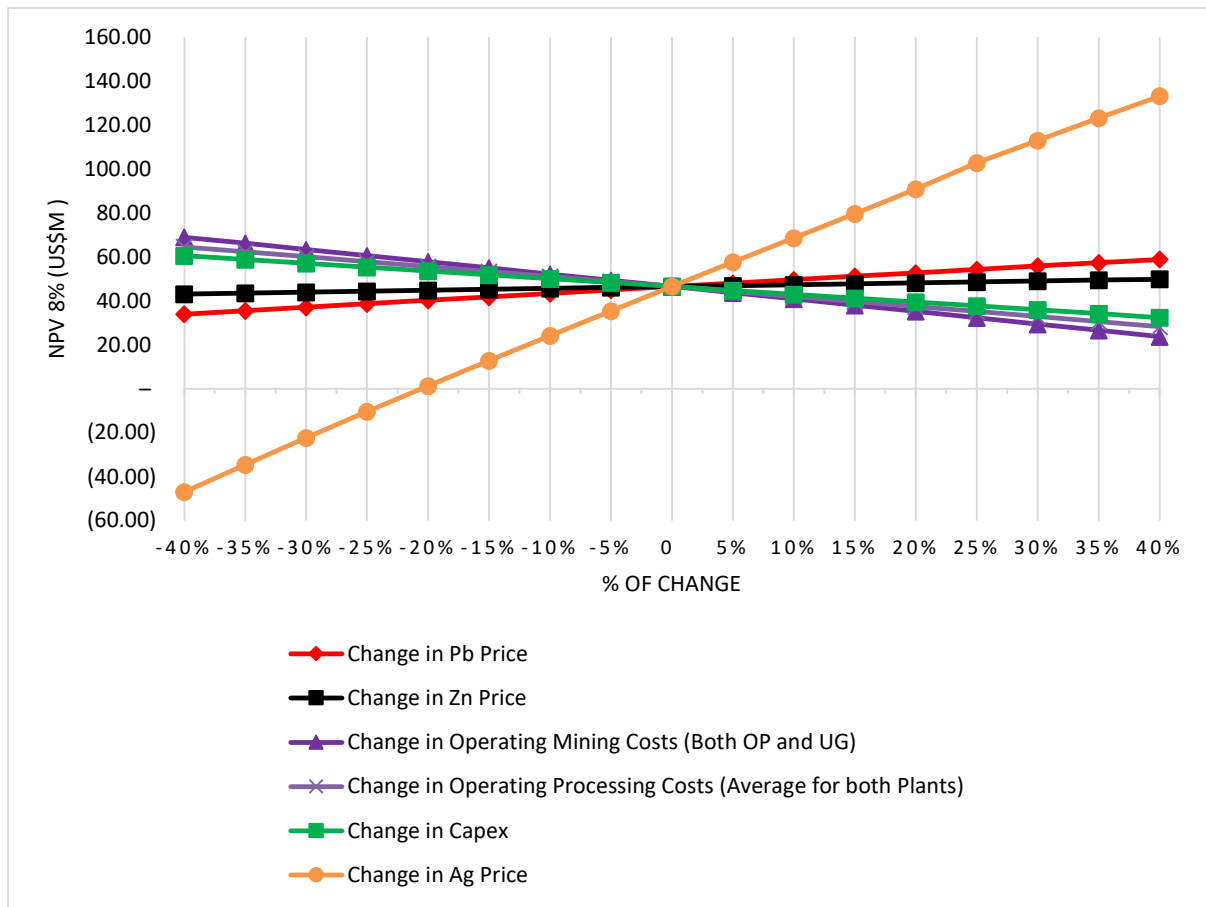


Figure 22.1: Project NPV (8.64%) Sensitivity Analysis Results

	60%	75%	90%	100%	110%	125%	140%
<b>Pb Price</b>	1,241	1,552	1,862	2,069	2,276	2,586	2,897
NPV @ 8.64%	29.56	33.96	38.36	41.30	44.23	48.63	53.01
<b>Zn Price</b>	1,351	1,689	2,027	2,252	2,477	2,815	2,815
NPV @ 8.64%	43.12	44.39	45.66	46.51	47.35	48.62	49.89
<b>Average Mining Opex</b>	29.69	37.12	44.54	49.49	54.44	61.86	69.29
NPV @ 8.64%	68.98	60.58	52.14	46.51	40.86	32.31	23.73
<b>Average Processing Opex</b>	24.80	31.00	37.20	41.33	45.47	51.67	57.87
NPV @ 8.64%	64.58	57.80	51.02	46.51	41.98	35.15	28.30
<b>Capex (US\$ M, nominal)</b>	25.80	32.25	38.71	43.01	47.31	53.76	60.21
NPV @ 8.64%	60.61	55.32	50.03	46.51	42.98	37.69	32.40
<b>Ag Price</b>	10.66	13.32	15.98	17.76	19.54	22.20	24.86
NPV @ 8.64%	-46.89	-10.30	24.10	46.51	68.60	102.84	133.14

## **23 ADJACENT PROPERTIES**

WAI is not aware of any properties adjacent to the Mangazeisky EL.



## 24 OTHER RELEVANT DATA AND INFORMATION

### 24.1 Risks and Opportunities

Areas of risk and opportunity material to the project are set out in Table 24.2 within the framework of the Strengths, Weaknesses, Opportunities and Threats (SWOT) analysis. The legend for the SWOT analysis is set out in Table 24.1.

Table 24.1: Legend for SWOT Analysis	
	Element related to Data
	Element related to Geology and Mineral Resources
	Element related to Mining
	Element related to Processing and Infrastructure
	Element related to Financial
	Element related to Other Modifying Factors

Table 24.2: SWOT Analysis for the Vertikalny and North Mangazeisky Projects	
<b>Strengths</b>	Adequate exploration SOPs and QA/QC procedures over 15 years since 2004 with good recovery of drill core. Low risk to provenance of data.
	Good reconciliation of grade control data over a nine-month period.
	Better definition of ore types and oxide/sulphide boundary since 2016 at Vertikalny.
	Density appears to be appropriately assigned to the model and is considered reasonable.
	Better confidence in Indicated resources as a result of metallurgical and infill drilling for Vertikalny.
	Issues in getting plant to early steady state much improved with installation of Merrill Crowe circuit in parallel.
	Preliminary Economic Assessment of combined project has resulted in positive NPV at various discount rates.
<b>Weaknesses</b>	Assay results for blanks for silver show their possible contamination. This needs to be reviewed in more detail with possible alternative material sought to replace current blank source.
	Infill drilling as part of the 2017 campaign did not demonstrate continuity as modelled for the 2016 MRE in the Vertikalny Southern Pit area down dip nor across the gap with Central Pit area.
	A lack of Measured and Indicated Resources defined for North Mangazeisky.
	The mining schedule indicates a significant increase in ramp up of waste material to be moved during 2020/21 in order to expose enough ore will put pressure on existing haulage fleet and availability of equipment in order to strip the required volumes of material.
	The schedule runs short of oxide for direct haul from pit to crusher in Q3 2020. There is a gap in production until the flotation circuit comes on stream in mid-2021. Careful consideration needs to be given as to how this is managed through stockpile drawdown and blending, reducing throughput and bringing in oxide material from off-balance resources and additional sources. Planning to ensure such material is available to mine

<b>Weakness</b>	and of the necessary oxide content (>55% target and tested in advance) needs to be considered.
	Lack of detailed geotechnical data and analysis for the Mangazeisky North Pit.
	The mineable tonnage does not represent Ore Reserves.
	Insufficient geotechnical data and analysis to refine the underground geotechnical design criteria as derived for the Vertikalny deposit by SRK Consulting in 2014.
	Disconnect between steady state underground production rate of 110ktpa used in the Vertikalny underground mine design (based on the design parameters outlined in the Tetra Tech study dated 21-08-17) and the production rate target used by WAI in underground scheduling was 272ktpa.
	Geometallurgical uncertainties and a lack of representative testwork to support definition of ore types, particularly at N. Mangazeisky distinguishing oxide from primary ore.
	Lack of practical XRT ore sorter testwork conducted on bulk primary ore.
	Lack of mobile equipment to maintain schedule and manage different streams and throughputs feeding the ore sorter.
	The current schedule assumes minimal time for a final tie-in of the upgraded plant (flotation circuit, additional crushing and grinding capacity).
	Lack of testwork conducted on Mangazeisky primary ore to confirm flotation response.
	Lack of variability testwork conducted on Vertikalny primary ore for hardness/grindability.
	Lack of phase analytical testwork conducted to define ore types on Mangazeisky oxide ore.
	No penalties have been considered in the PEA valuation due to limited geological data and undefined payment terms.
<b>Opportunities</b>	Initiate representative phase analytical testwork on existing samples from N. Mangazeisky core to define the oxide/sulphide boundary. Subject to access, haulage and permitting, this would open up oxide resources amenable to fill the production gap as oxide runs out in Q3 2020.
	Low-grade stockpiled (stockpile no.5) oxide material may offer an opportunity to address the oxide feed gap indicated in the production schedule although further sampling and testing is recommended before being considered a viable source of feed to bridge the oxide production gap.
	XRT sorter presents an opportunity to increase recovery and reduce operating costs but has yet to be tested at a commercial scale on sulphide ore in particular
<b>Threats</b>	Downgrade of the previous MRE for Vertikalny at a 200g/t Ag cut-off grade for open pit by 3% on grade and 29% on tonnes if taking into account mined-out material. For UG resources at 300g/t Ag cut-off grade was decreased by 24% and tonnes by 56% due to re-interpretation of mineralisation.
	The downgrade has put pressure on the amenability of sulphide ore to be mined and increased the strip ratio.
	Should mining productivity or equipment capacity be lower than required to move waste during the pushback in Central Vertikalny, ore production may be adversely impacted and exacerbate the oxide feed gap.
	Should a smooth ramp-up period be required during construction of the flotation plant, actual metal production may be lower than that indicated in the production schedule; therefore, adversely impacting project economics.

<b>Threats</b>	Underground development dimensions must be re-evaluated to accommodate the potentially larger equipment required to achieve the higher production rates.
	Greatest threat is understanding the processing characteristics of the sulphide ore scheduled for throughput for 2020/2021 through the existing plant. High risk that recoveries may be lower and more variable than scheduled depending on the amount of sulphide in the blend feeding the Merrill/electrowinning circuit and hardness of the sulphide ore through the crusher feeding the concentrator. Testwork needs to be done on synthetic mixes of the expected blends of oxide:sulphide for this period.
	Effect of penalty elements in the final Pb and Zn concentrates and constraints on smelter contracts.
	Risk to sorter scheduling and ultimately production from low FEL availability. An additional FEL is recommended for the ore sorting area.
	Mining capital and operating cost estimates are based on a Preliminary Economic Assessment (PEA) level of confidence ( $\pm 45\%$ ). The study offers a valuable view in determining the merits of pursuing further engineering studies but should not be the sole reference for the purposes of economic decision making.
	From the threat to understanding the processing characteristics of sulphide ore there is reliance on data for concentrates produced on sparse historical testwork data and subsequent risk to saleability of the final Pb concentrate products.

The following presents a synthesis of the major risks and recommendations for actions to mitigate. The matrix is presented in a tabular matrix format colour-coded so issues and high-risk areas can be readily flagged as follows:

Risk Category	Definition
	Critical (unquantifiable but warrants a halt to proceed pending critical decision)
	Significant ( $\geq 30\%$ negative impact on metal, costs or revenue)
	Moderate ( $\geq 10\%$ and $\leq 30\%$ negative impact on metal, costs or revenue)
	Low ( $< 10\%$ negative impact on metal, costs or revenue)

ITEM	DESCRIPTION	STATUS	ISSUES	ACTIONS/MITIGATIONS	PRIORITY
<b>1</b>	<b>Licence Tenure</b>				
1.1	Security of Tenure	CSJC Prognoz is in possession of a mining licence YaKU 03626 BE for Vertikalny. The license has an expiry date of 01.09.2033 and covers an area of 13.55 km <sup>2</sup> CSJC Prognoz is in possession of an exploration licence with the reference YaKU 12692 BP for North Mangazeiskiy. The license has an expiry date of 31.12.2023 and covers an area of 570 km <sup>2</sup> .	None. Valid for silver extraction.	None	LOW
1.2	Compliance with Licence Agreement	Not considered	Assumed sub-soil licence compliant, no material violations in conditions to jeopardize terms of licence agreement.	None	
1.3	Project Permitting	Not considered	Assumed all necessary project and construction permits in place.	None	
<b>2</b>	<b>Resources and Reserves</b>				
2.1	Resource base Vertikalny	As per Tables 14.21 and 14.22, effective 31.05.2019.	Downgrade of the previous MRE for Vertikalny at a 200g/t Ag cut-off grade for open pit by 3% on grade and 29% on tonnes if taking into account mined-out material. For UG resources at 300g/t Ag cut-off grade was decreased by 24% and tonnes by 56% due to re-interpretation of mineralisation.	No material change since effective date. Reasons for downgrade: <ul style="list-style-type: none"> <li>Re-interpretation of mineralized structures to incorporate new infill drilling. Lower global grade with more conservative search parameters but higher confidence with closer drill spacing;</li> </ul>	LOW

				<ul style="list-style-type: none"> <li>• A more conservative approach for Inferred resource definition;</li> <li>• Introduction of oxide/primary which was not distinguished in the TT resource. This has been important in drawing in a better-defined open pit table oxide resource and reclassified some of the TT indicated resource as inferred;</li> <li>• Using separate Net Smelter Return parameters for both oxide/primary and open pit/underground resource definition.</li> <li>• mineralisation boundary based on the recent testwork data</li> </ul>	
2.2	Resource base Mangazeiskiy	As per Table 14.38, effective 31.05.2019.	Reclassification to inferred at 200g/t Ag cut-off grade due to a lack of definition of ore types on the deposit supported by testwork. Contained <i>in-situ</i> silver for Mangazeisky deposit reduced by 28%, average silver grade may be increased by 14%.	No material change since effective date. Reasons for change due to application of constraining wireframes and search parameters more appropriate to the style of mineralization but provides better consistency in distribution of silver grade.	MOD
2.3	Data Adequacy	Anomalous assay results from blank samples. Accuracy of Pb/Zn duplicates.	Potential contamination from high grade silver.		LOW
2.4	Reconciliation	Good reconciliation of grade control data over a nine-month period in 2019.	Short period and small population.	Study recommended to expand and include all long & short-term GC data.	LOW

<b>3</b>	<b>Mining Engineering</b>				
3.1	Mining Equipment	<p>Current status of equipment deployed:</p> <ul style="list-style-type: none"> <li>• 1x CAT 336 DL Excavator;</li> <li>• 1x CAT 349 DL Excavator;</li> <li>• 1x Sunward SWDE-120Atl Blast rig;</li> <li>• 1x URB-2A2 truck mounted Blast rig;</li> <li>• 8x Scania G440 trucks;</li> <li>• 2x CAT D9R Dozers;</li> <li>• 2x CAT 950GC FELs;</li> <li>• 1x SEM-922 Grader</li> </ul>	<p>None. Fleet is adequately sized to meet future production in the conceptual schedule provided utilization, availability and maintenance is optimized.</p>	<p>May enhance and reduce risk through direct lease of replacement fleet from supplier(s) or contractor with own operators.</p> <p>Additional FEL recommended for sorting circuit to ensure availability in ore sorting area.</p>	MOD
3.2	Production Scheduling	<ul style="list-style-type: none"> <li>• Key stage in diverting equipment from Vertikalny South to Central pit to undertake pushback in 2021.</li> <li>• Production shortfall starting end Q3 2020 when oxide depletes to full commissioning of sulphide flotation plant in Q2 2021.</li> </ul>	<p>As much attention needs to be given to waste haulage at this time as ore haulage at a time when several faces may need to be available to access/blend oxide ore.</p> <p>WAI accepts the shortfall can be addressed and the production gap narrowed but risk remains to production hiatus or lower recovery through the oxide plant as the result of blending sulphide material.</p>	<ul style="list-style-type: none"> <li>• Ensure timely commissioning of sulphide plant.</li> <li>• Open up alternative sources of oxide as a back-up. This can be from;                             <ul style="list-style-type: none"> <li>- N Mangazeisky (reserves approved but not well defined with added transport costs and permitting)</li> <li>- Vertikalny, extension to current open pits or near pit upside resources. (well defined but not necessarily approved).</li> </ul> </li> </ul>	HIGH
<b>4</b>	<b>Geotechnical</b>				
4.1	Geotechnical	<p>Basis of design at definition phase study level for Vertikalny underground.</p> <p>North Mangazeisky Open Pit</p>	<p>Study required to support underground design to establish rating of rock mass and stand-up for development, stopes and infrastructure.</p> <p>Needs greater definition and study for pit slope stability</p>	<p>Programme of geotechnical drilling within next 2 years</p>	LOW

<b>5</b>	<b>Metallurgy</b>	Processing characteristics of oxide and sulphide planned for transition period as oxide depletes and sulphide comes on stream.  Penalty elements in Pb concentrate.	<ul style="list-style-type: none"> <li>Oxide ore well defined but process characteristics of transition/sulphide material not so well understood as scheduled for this period. Risk of variable and lower recoveries than estimated.</li> <li>Lack of representative testwork to support definition of ore types, particularly at N. Mangazeisky distinguishing oxide from primary ore.</li> </ul> <p>Potential concentrates on smelter contract for Pb/Zn concentrate</p>	Geometallurgical testwork incorporating bulk sampling required to inform the plant 1 month and eventually 1 week in advance.	<b>HIGH</b>
<b>6</b>	<b>Processing</b>				
6.1	Process Plant	<ul style="list-style-type: none"> <li>Merrill Crowe circuit installed in parallel with SXEW.</li> <li>XRT sorter installed and undergoing commissioning.</li> <li>Construction and schedule for sulphide flotation plant.</li> </ul>	Demonstrable improvement in recovery and subsequent opcosts. Needs to be fully tested on a commercial basis with ore trialled through a separate line. Not assessed at time of writing.		<b>MOD</b>
6.2	Tailings Storage Facility (TSF)	Not Assessed as part of this exercise.			
<b>7</b>	<b>Infrastructure</b>	Not Assessed as part of this exercise.			
<b>8</b>	<b>Hydrology &amp; Hydrogeology</b>	Level of definition of supporting studies	Current permafrost assumptions reasonable but requires verification and greater level of understanding of variability. Cannot assume zero flow in permafrost conditions.	As part of geotechnical study needs greater definition for surface water management and seasonal pit inflow and effect of Talikhs in the groundwater model across the site.	<b>LOW</b>
<b>9</b>	<b>Financial</b>				

9.1	Capital Costs	<ul style="list-style-type: none"> <li>Open Pit Capital Costs: <b>US\$ 2.53M</b></li> <li>Underground Capital Costs: <b>US\$ 23.33M.</b></li> <li>US\$17.3M for 500 tpd new plant reducing to US\$9M if the existing oxide circuit can be retrofitted.</li> </ul>	Cost assumptions for financial modelling are reasonable at a PEA level of accuracy.		LOW
9.2	Operating Costs Mining	<ul style="list-style-type: none"> <li>Open Pit Operating Costs: <b>US\$ 2.17 /tMINED</b></li> <li>Underground Operating Cost: <b>US\$ 40.56/tORE</b></li> </ul>	<p>Cost assumptions for financial modelling are reasonable at a PEA level of accuracy.</p> <p>These costs do not reflect cost parameters used in NPV optimisation which use actual operating cost numbers prior to November 2019. Financial model parameters are more optimistic than the NPV optimisation parameters used to constrain the open pit resources in the MRE.</p>	See below.	MOD
9.3	Operating Costs Processing	<p>Total <b>US\$47.18/t</b> concentrate for financial analysis compared with Tetra Tech design opcost of <b>US\$121.8/t.</b> Assumptions based on improvements in oxide plant, finer grind and optimal reagent consumptions.</p> <p>YTD opcost of <b>US\$74/t</b> used in NPV optimization.</p>	<p>Cost assumptions for financial modelling are reasonable at a PEA level of accuracy.</p> <p>These costs do not reflect cost parameters used in NPV optimisation which use actual operating cost numbers prior to November 2019. Financial model parameters are more optimistic than the NPV optimisation parameters used to constrain the open pit resources in the MRE.</p>	Financial Model needs greater definition and level of accuracy from 'steady state' G&A and process costs once data has been fed back from the expected improvements (oxide processing, sorting, sulphide flotation etc).	HIGH



## 25 CONCLUSIONS & RECOMMENDATIONS

### 25.1 Vertikalny - Mineral Resource Estimate

In WAI opinion, the established understanding of the geological and grade continuity is sufficient to support the classification of the Mineral Resources as Measured Indicated and Inferred.

At Vertikalny, a pit shell wireframe was used to constrain the open pit resource in order to demonstrate that the resource has reasonable prospects for economic extraction. Underground Mineral Resources located below the base of the optimised pit shell and above the NSR cut-off value of US\$162.0/t.

Mineral Resources are estimated as of 31 May 2019 based on an open pit mine survey of the same date.

### 25.2 Mangazeisky North – Mineral Resource Estimate

Since it is impossible to delineate and determine the geometry of oxide and primary mineralization at Northern Mangazeisky, WAI believes that the silver, lead, and zinc resources can only be classified as Inferred.

At Northern Mangazeisky, a pit shell wireframe was used to constrain the open pit resource in order to demonstrate that the resource has reasonable prospects for economic extraction.

Mineral Resources are estimated as of 31 May 2019.

### 25.3 Hydrological & Hydrogeological Review

The following comments are made based on the work completed:

- The assumption that the underground mine will be dry with negligible ground water inflow (“Tetra Tech 2017 pp.16-74”) needs to be confirmed. The assumption is based on limited mine data, extrapolation of permafrost base levels and a homogenous distribution of hydraulic property values and geometry. It is probable given the increased depth of the underground workings in Vertikalny Zones 1 and 4 that free flowing groundwater will be encountered in lower levels.
- The occurrence of artesian conditions in boreholes below the permafrost in the Sirilendzhe River valley demonstrates the confining behaviour of the permafrost isolating the aquifer from surface waters across most of the catchment. We have not seen any comment however on the potential for elevated porewater pressures below the permafrost and whether this could be a modifying factor to mining.
- The overall conclusions about the permafrost are reasonable based on the data available for the open pit but require verification. More understanding of the

potential heterogeneity of hydraulic properties across the pit area is required. Modifiers that may affect groundwater in the pit include preferential flow zones, alteration and mineralisation, hydro-stratigraphy (layering) and subordinate structures and fracture zones. Permafrost behaviour may be substantially altered where there are conduits such as fault and fracture zones creating mechanisms for groundwater circulation or recharge. The permafrost distribution will likely change once the pit has been developed and new thermal equilibria are established.

- It is agreed that the placement of the proposed water supply borehole near borehole GS15-05 remains the most suitable location on the basis of yield and supply.

## 25.4 Geotechnical Review

WAI has carried out a review of the geotechnical information provided by SBR for the Vertikalny and Mangazeisky North deposits. The review has aimed to summarise the geotechnical parameters for use in mine optimisation and design. Information was drawn from the findings of the geotechnical study carried out by SRK consulting in late 2014.

The geotechnical characteristics of the Vertikalny rock mass are considered to be suitably detailed and well defined. The open pit design parameters were defined by SRK based on kinematic and numerical slope stability analysis. The underground design parameters were taken from the Tetra Tech study; having originally been derived from the SRK study. The underground design parameters were defined by SRK using industry standard techniques; inclusive of Barton's Q system, Mathew's stability graph method and numerical modelling. The geotechnical work was underpinned by relatively robust geotechnical dataset collected by SRK in support of the study.

The geotechnical characteristics of the Mangazeisky North deposit are poorly defined. WAI were unable to gather any detailed structural or rock mass strength data. Consequently, the derived mine optimisation and design parameters were based on a standard WAI base case; not detailed geotechnical analysis. A geotechnical data collection exercise will be required to support further geotechnical analysis and substantiate any derived mine optimisation and design criteria.

## 25.5 NSR Model

A basic Net Smelter Return (NSR) calculation was performed which considered grade, metal price, metallurgical recovery, and metal payability. The payable metal includes the applicable concentrate and refining charges but does not include price participation or penalty element payments. The metal price assumptions were derived by WAI and approved by SBR. All metallurgical recoveries/costs used in the NSR calculation are based on data provided by SBR.

WAI notes that only the sulphide blocks have considered the value contributions of each payable element. This is based on the premise that most of the sulphide blocks will be processed through a flotation plant; following depletion of the oxide blocks which form a relatively contiguous volume within the current Vertikalny pit. Oxide blocks have only considered the value contribution of silver.

NSR factors were calculated and directly applied to each block within the Resource block models. This enabled the subsequent mine optimisation exercises to be carried out on the block NSR values. The NSR model forms a critical input into the development of the mining study and further detail regarding the NSR inputs must be understood to enhance the confidence of the study.

The key recommendations to improve the confidence of the NSR model are listed below:

- Marketability of concentrate products (especially lead concentrate due to low lead assay);
- Identify concentrate off-takers and generation of agreements in principle; and,
- NSR input parameters (i.e., concentrate moisture content, metal payability, metal deductions and penalties, transport costs, treatment, and refining charges, etc.).

## 25.6 Open Pit Mining

WAI has carried out an open pit mining study to define a mineable tonnage estimate for the Vertikalny and Mangazeisky North deposits.

Open pit optimisation was carried out using the Datamine NPV Scheduler v4 (NPVS) software package. Pit optimisations were carried out on the Resource block models generated for the two deposits and driven on the calculated block NSR values. The optimisations included *Measured*, *Indicated* and *Inferred* resources.

Detailed mine designs were generated from the selected optimal shells using the Datamine Studio OP V2.4 general mine planning package. The designs were used to derive the mineable tonnage estimates and formed the basis for subsequent production scheduling. It should be noted that 'mineable tonnage estimates' are not Ore Reserves and are not demonstrative of technical and economic viability.

The key recommendations to improve the confidence of the open pit mining study are listed below:

- Further refine the access requirements for Vertikalny Pit1 and Mangazeisky North pit;
- Conduct dilution and loss study specific to the Mangazeisky North pit;
- Generate and implement new pit design criteria for the Mangazeisky North pit following geotechnical data collection, investigation, and analysis;
- Carry out waste dump design and positioning exercise to improve confidence in the waste disposal strategy; and,
- Carry out optimisation on *Measured* and *Indicated* Resources to determine influence of *Inferred* Resources and identify measures to improve geological confidence.

## 25.7 Underground Mining

WAI has carried out a mining study to define an underground mineable tonnage estimate for the Vertikalny deposit. The study has considered the volume of mineralised material below the generated Vertikalny pit designs.

Underground mineable tonnage estimates were prepared using the Vertikalny Resource block model. Stope optimisation was completed using the Mineable Shape Optimiser (MSO) module in the Datamine Studio 5D Planner software package. The optimisations included *Measured*, *Indicated* and *Inferred* resources.

A total of four underground mining zones were designed in line with generated stope zones. The designs were used to derive the mineable tonnage estimates and formed the basis for subsequent production scheduling. It should be noted that 'mineable tonnage estimates' are not Ore Reserves and are not demonstrative of technical and economic viability.

The key recommendations to improve the confidence of the underground mining study are listed below:

- Further geotechnical studies are required to optimise the stope dimensions, identify the in-situ pillar requirements to ensure regional underground stability, identify stand-off distance of access declines from mineralised zones, etc.;
- Ventilation studies are required to understand airflow requirements, identify suitable primary/secondary fan sizes, generate more detailed ventilation costs, etc.; and,
- The original Tetra Tech design was carried out on the basis of resource estimates which have since been downgraded due to revised geological conditions. It will be necessary to carry out further stope optimisation on *Measured* and *Indicated* Resources to determine influence of *Inferred* Resources and identify measures to improve geological confidence.
- Underground development dimensions used in the Vertikalny underground mine design were based on the design parameters outlined in the Tetra Tech study (dated 21-08-17). The Tetra Tech study assumed a steady state underground production rate of 110ktpa. The production rate target used by WAI in underground scheduling was 272ktpa. This is due to the higher capacity of the new flotation plant (180ktpa) and the presence of an upstream ore sorter which rejects approximately 33% of ROM plant feed. Underground development dimensions must be re-evaluated to accommodate the potentially larger equipment required to achieve the higher production rates.

## 25.8 Mine Production Scheduling & Equipment Requirements

The generated mine designs were used as the basis for developing a combined open pit and underground production schedule. Effort was made to sequence the operations such that a steady

flow of plant feed is maintained over the life-of-mine. Key points noted from the generated production schedule include:

- Overall mine life anticipated at just over 8 years,
- Depletion of oxide feed from Vertikalny pit anticipated at the end of Y2 (2020); indicating the point at which floatation plant would likely need to be established,
- Mining at Mangazeisky North anticipated to commence in Q3 of Y3 (2021) with production ceasing at the start of Y5(2023),
- Underground pre-production development anticipated to start at the end of Y3 (2021) with stope production commencing at the start of Y5 (2023).

The permitting requirements and minimum time required to commence mining at the Mangazeisky North deposit must be understood.

Open pit and underground mining equipment requirements were estimated on first principles analysis to achieve the generated production schedule. No ventilation studies were carried out for the underground mining operations and it is recommended that such studies be considered in more detailed engineering studies.

## 25.9 Capital and Operating Costs – Mining

A mining cost model was developed to assess the open pit and underground mining capital and operating expenditures for the Mangazeisky Project. The cost estimates were developed by WAI based on data provided by SBR and WAI's internal cost database.

A summary of the costs is presented below:

Open Pit Capital Costs:	<b>US\$2.53M</b>
Open Pit Operating Costs:	<b>US\$2.17 /t<sub>MINED</sub></b>
Underground Capital Costs:	<b>US\$23.33M</b>
Underground Operating Cost:	<b>US\$40.56/t<sub>ORE</sub></b>

The calculated mining cost estimates are lower than those used in open pit and underground optimisation; implying a degree of margin within the generated mine designs. Given the level of study, WAI consider the differences in costs to be acceptable

The calculated costs are estimated to have an accuracy equivalent to a Preliminary Economic Assessment (PEA) level of detail. The study offers a valuable view in determining the merits of pursuing further engineering studies but should not be the sole reference for the purposes of economic decision making.

## 25.10 Processing

After producing first silver production in April 2018, silver recoveries have generally been in the range of 60-70%, compared to 85% design, but since April 2019 have been steadily increasing to >82% in July. This is thought to be due mainly to better washing of the leach tailings solids filter cake, where Benitex reported that up to 19% of the silver was previously being lost due to poor washing. There is also likely an impact due to primary ore being included in the oxide feed, reportedly 5-15% according to SBR. Higher cyanide concentrations of 5,000ppm are being utilised to allow for this, compared to the design of 2,000ppm.

Therefore, WAI recommends that the design silver recovery of 85% for oxide ore is appropriate to be used for pit optimisation studies.

The additional impact of any primary ore in the oxide feed will be higher reagent consumptions and moderate increases in cyanide and steel ball consumption are noted compared to design.

The lime consumption, however, is significantly higher than design, although this appears to be due to an incorrect design figure of 0.7kg/t used in the feasibility study, compared to the testwork data of 20-30kg/t, which translates to an expected field consumption rate of approximately 15kg/t. Further issues contributing to the actual lime consumption of 23.9kg/t are low activity and inefficient dosing, so there is scope to reduce the lime consumption. Overall process unit costs are also higher due to the lower throughput compared to design.

However, at this stage, WAI recommends using the actual YTD process operating cost of US\$74.9/t for oxide ore for pit optimisation studies.

For the proposed processing of primary sulphide ore, the process design incorporates a new flotation circuit for the production of separate lead and zinc concentrates, with cyanide leaching of the lead flotation middlings as per the current circuit configuration. Most of the existing circuit can be utilised with the addition of the new flotation circuit and extra crushing and milling capacity.

The capital cost of approximately US\$17.3M is considered reasonable for an approximate 500 tpd new operation, although this reduces to approximately US\$9M if the existing oxide circuit can be used and the additional equipment retro fitted. Much will depend on whether there is a requirement to process both oxide and sulphide ores at the same time, or whether sulphide processing can start after oxide resources are depleted.

## 25.11 Financial Analysis

Preliminary Economic Assessment of Mangazeisky project has resulted in positive NPV at various discount rates. The project is mostly sensitive to change in Silver prices. Base Case NPV @ Discount Rate of 8.64% was estimated at US\$46.51M (nominal values).

The Project is mostly sensitive to changes in Silver prices. Break-even price of the Project has been estimated at US\$14.11/oz, which is 21% lower than the base case silver price assumption.

Current financial results have been derived from the production schedule that considers oxide material from stockpile No 5, in the amount of approximately 50kt.

WAI notes that no penalties have been considered in the PEA valuation and includes the approximate estimate of the payable metal content. This is due to limited geological data on penalty elements, concentrate characteristics based on limited historical testwork results and lack of potential off-take agreements with buyers given lead and zinc concentrates are not going to be produced earlier than Q4 2021. Hence there is a downside risk in the marketability of the lead concentrate.

Upside potential is seen as significantly improved concentrate quality and consequently improved project economics, should further testwork confirm better concentrate grade.

## 26 REFERENCES

- GINTSVETMET (2011). A Scientific Research Report on Ore Processing Metallurgical Tests for the Mangazeyskoye Deposit. Contract No 17/11. 2011.
- OOO NVP Centre-ESTAgeo (2018). Mineral Technology Report on all Technological Types of Ore on the Vertikalny Deposit with Justification and Development of a Rational Scheme for their Processing and Developing a Technological Flowsheet. Moscow 2018.
- SGS Vostok (2014). An Investigation into the Mineral Characteristics of a Feed Sample from the Mangazeisky Silver Project, Russia. Prepared for Silver Bear Resources Inc. Project 14426-001 – Final Report. November 2014.
- Tetra Tech (2015a). Technical Report and Resource Estimate of the Mangazeisky Silver Project. Document No. 1454430300-REP-R0003-01. April 2015.
- Tetra Tech (2016a). Technical Report and Resource Estimate on the Mangazeisky Silver Project, Mangazeisky North Deposits, Yakutia, Russia. Document No. 705-1454430300-REP-R0005-01. April 2016.
- Tetra Tech (2016b). NI 43-101 Technical Report Feasibility Study, Mangazeisky Silver Project, Republic of Sakha (Yakutia), Russian Federation. Document No. 705-1454430300-REP-R0001-06. 9th June 2016.
- Tetra Tech (2017) NI 43-101 Technical Report, Mangazeisky Silver Project, Republic of Sakha (Yakutia), Russian Federation. Report:1454430200-REP-R0006-02. Swindon. August 2017.
- TOMS Institute, LLC (2015a). Brief Study Report: Metallurgical Study of Ore Samples from Verticalnoye Deposit. Prepared for ZAO Prognoz. Reference Number No И3-150115-B/030315-1.
- TOMS Institute, LLC (2015b). R&D Report: Technology Researches of Primary Ore – Verticalnoye Deposit. Prepared for ZAO Prognoz. Reference Number No R&D161115 B/2412151. 27th November 2015.
- TSNIGRI (2008). Report Scientific Research “Technological Estimation of Samples of Silver-Polymetal Ores of Mengazeysky Deposit. Agreement #048. April 2008.
- Wardrop (2009a). Technical Report for the Mangazeisky Project, Republic of Sakha (Yakutia), Russian Federation. Document No. 0854430100-REP-R0001-01. March 2009.
- Wardrop (2009b). Technical Report for the Mangazeisky Project, Republic of Sakha, Russian Federation. Document No. 0854430100-REP-R0003-02. December 2009.
- Wardrop Engineering Inc. (2011). NI 43-101 Technical Report – Scoping Study for the Vertikalny Deposit, Mangazeisky Project. September 2011.
- Western Services Corp. (2004).



## 27 CERTIFICATES OF QUALIFIED PERSONS

### Ché Osmond, CGeol

As a Qualified Person of the Technical Report on the Mangazeisky Silver Project, Republic of Sakha (Yakutia), Russian Federation, I, Ché Osmond, do hereby certify:

- I am a Technical Director with Wardell Armstrong International, with a business address at Baldhu House, Wheal Jane Earth Science Park, Baldhu, Truro, Cornwall, United Kingdom TR3 6EH.
- This certificate applies to the technical report entitled “NI 43-101 Technical Report Mangazeisky Silver Project MRE Update and Strategy Re-Assessment, Republic of Sakha (Yakutia), Russian Federation” dated 10<sup>th</sup> November 2021 (the “Technical Report”).
- I am a graduate of Oxford Brookes University, (BSc (Hons) Geology & Cartography, 1995) and Camborne School of Mines (Exeter University) (MSc Mining Geology, 1997). I have practiced my profession continuously since 1997. During my employment as a mining consultant I have frequently authored or reviewed for a variety of commodities, including precious metals with a particular focus on exploration, mineral resource evaluation, and project development.
- I have read the definition of “qualified person” set out in NI 43-101 (“the Instrument”) and certify that by reason of my education, affiliation with a professional association and past relevant work experience, I fulfil the requirements of a “Qualified Person” for the purposes of the Instrument.
- I am a registered member in good standing of the Geological Society of London as a Fellow and Chartered Geologist (# 1016839) and a registered European Geologist as elected by the European Federation of Geologists.
- I have not personally inspected the Property that is the subject of this Technical Report.
- I am responsible for Items 1.1, 1.6, 1.13, 2 (except 2.2.1) through 12 (except 12.3), 18, 19, 21.1, 22, 23, 24, 25.5, 25.11, and 26 of the Technical Report.
- I am independent of Silver Bear Resources plc. as defined by Section 1.5 of the Instrument.
- I have no prior involvement with the Property that is the subject of this Technical Report.
- I have read the Instrument and Form 43-101F1, and the Technical Report has been prepared in compliance with NI 43-101 and Form 43-101F1.
- As of the effective date of this certificate, to the best of my knowledge, information, and belief, the sections of Technical Report that I am responsible for contain all scientific and technical information that is required to be disclosed to make the Technical Report not misleading.

Dated this 10<sup>th</sup> day of November 2021

**(Signed & Sealed) Ché Osmond**

Ché Osmond  
BSc (Hons), MSc, CGeol, EurGeol, FGS

**Alan Clarke, CGeol**

As a Qualified Person of the Technical Report on the Mangazeisky Silver Project, Republic of Sakha (Yakutia), Russian Federation, I, Alan Clarke, do hereby certify:

- I am an Associate Director with Wardell Armstrong International, with a business address at Baldhu House, Wheal Jane Earth Science Park, Baldhu, Truro, Cornwall, United Kingdom TR3 6EH.
- This certificate applies to the technical report entitled “NI 43-101 Technical Report Mangazeisky Silver Project MRE Update and Strategy Re-Assessment, Republic of Sakha (Yakutia), Russian Federation” dated 10<sup>th</sup> November 2021 (the “Technical Report”).
- I am a graduate of Edinburgh University, (BSc (Hons) Geology, 2002) and Camborne School of Mines (Exeter University) (MSc Mining Geology, 2003). I have practiced my profession continuously since 2003. During my employment as a mining consultant I have frequently authored or reviewed for a variety of commodities, including precious metals with a particular focus on exploration, drilling, and mineral resource estimation.
- I have read the definition of “qualified person” set out in NI 43-101 (“the Instrument”) and certify that by reason of my education, affiliation with a professional association and past relevant work experience, I fulfil the requirements of a “Qualified Person” for the purposes of the Instrument.
- I am a registered member in good standing of the Geological Society of London as a Fellow and Chartered Geologist (# 1014124) and a registered European Geologist as elected by the European Federation of Geologists.
- I have not personally inspected the Property that is the subject of this Technical Report.
- I am responsible for Items 1.2, 1.3, 14, 25.1, and 25.2 of the Technical Report.
- I am independent of Silver Bear Resources plc. as defined by Section 1.5 of the Instrument.
- I have no prior involvement with the Property that is the subject of this Technical Report.
- I have read the Instrument and Form 43-101F1, and the Technical Report has been prepared in compliance with NI 43-101 and Form 43-101F1.
- As of the effective date of this certificate, to the best of my knowledge, information, and belief, the sections of Technical Report that I am responsible for contain all scientific and technical information that is required to be disclosed to make the Technical Report not misleading.

Dated this 10<sup>th</sup> day of November 2021

**(Signed & Sealed) Alan Clarke**

Alan Clarke,  
BSc (Hons), MSc, CGeol, EurGeol, FGS

### **Sassoun Horsley-Kozadjian, CEng**

As a Qualified Person of the Technical Report on the Mangazeisky Silver Project, Republic of Sakha (Yakutia), Russian Federation, I, Sassoun Horsley-Kozadjian, do hereby certify:

- At the time of preparing this report I was a full-time employee of Wardell Armstrong and employed as a Principal Mining Engineer, based at Baldhu House, Wheal Jane, Truro, Cornwall, TR3 6EH, United Kingdom.
- This certificate applies to the technical report entitled “NI 43-101 Technical Report Mangazeisky Silver Project MRE Update and Strategy Re-Assessment, Republic of Sakha (Yakutia), Russian Federation” dated 10<sup>th</sup> November 2021 (the “Technical Report”).
- I graduated with a Bachelor of Engineering (Hons) Degree in Mining Engineering from the University of Exeter, UK, in 2012 and thereafter graduated with a Masters of Science Degree in Applied Geotechnics from the University of Exeter, UK, in 2013. I have practiced my profession as a mining engineer continuously since 2013. During my career I have prepared numerous mining studies including mine design and scheduling on a range of commodities including precious metals.
- I am a registered member in good standing with the Institute of Materials, Minerals & Mining as a Professional Member and Chartered Engineering as elected by the Engineering Council.
- I have read the definition of “qualified person” set out in NI 43-101 (“the Instrument”) and certify that by reason of my education, affiliation with a professional association and past relevant work experience, I fulfil the requirements of a “qualified person” for the purposes of the Instrument.
- I have not personally inspected the property that is the subject of this Technical Report.
- I have no prior involvement with the property that is the subject of the Technical Report.
- I am responsible for Items 1.5, 1.7 through 1.10, 16 (except 16.2), 21.2, 21.3, 25.4, and 25.6 through 25.9 of the Technical Report.
- I am independent of the issuer as defined in section 1.5 of the Instrument.
- I am independent of Silver Bear Resources plc. as defined by Canadian NI 43-101 regulations and have provided consulting services to the companies.
- I have read the Instrument and Form 43-101F1, and the Technical Report has been prepared in compliance with NI 43-101 and Form 43-101F1.
- As of the effective date of this certificate, to the best of my knowledge, information, and belief, the sections of Technical Report that I am responsible for contain all scientific and technical information that is required to be disclosed to make the Technical Report not misleading.

Dated this 10<sup>th</sup> day of November 2021.

**(Signed & Sealed) Sassoun Horsley-Kozadjian**

Sassoun Horsley-Kozadjian  
BEng (Hons), MSc, CEng, MIMMM

**James Turner, CEng**

As a Qualified Person of the Technical Report on the Mangazeisky Silver Project, Republic of Sakha (Yakutia), Russian Federation, I, James Turner, do hereby certify:

- I am a Technical Director with Wardell Armstrong International, with a business address at Baldhu House, Wheal Jane Earth Science Park, Baldhu, Truro, Cornwall, United Kingdom TR3 6EH.
- This certificate applies to the technical report entitled “NI 43-101 Technical Report Mangazeisky Silver Project MRE Update and Strategy Re-Assessment, Republic of Sakha (Yakutia), Russian Federation” dated 10<sup>th</sup> November 2021 (the “Technical Report”).
- I am a graduate of the Camborne School of Mines (BSc (Hons) Mineral Processing Technology, 1984, and MSc Minerals Engineering, 1993). I have practiced my profession continuously since 1984. During my employment as a mining consultant I have frequently authored or reviewed for a variety of commodities, including precious metals with a particular focus on metallurgical testwork and mineral processing.
- I have read the definition of “qualified person” set out in NI 43-101 (“the Instrument”) and certify that by reason of my education, affiliation with a professional association and past relevant work experience, I fulfil the requirements of a “Qualified Person” for the purposes of the Instrument.
- I am a member in good standing of the Institute of Materials, Minerals and Mining and a Chartered Mineral Processing Engineer registered with the Engineering Council of the U.K. (# 413242).
- I have not personally inspected the Property that is the subject of this Technical Report.
- I am responsible for Items 1.11, 1.12, 13, 17, 21.4, and 25.10 of the Technical Report.
- I am independent of Silver Bear Resources plc. as defined by Section 1.5 of the Instrument.
- I have no prior involvement with the Property that is the subject of this Technical Report.
- I have read the Instrument and Form 43-101F1, and the Technical Report has been prepared in compliance with NI 43-101 and Form 43-101F1.
- As of the effective date of this certificate, to the best of my knowledge, information, and belief, the sections of Technical Report that I am responsible for contain all scientific and technical information that is required to be disclosed to make the Technical Report not misleading.

Dated this 10<sup>th</sup> day of November 2021

**(Signed & Sealed) James Turner**

James W.G. Turner  
BSc. (Hons), MSc., MIMMM, CEng

**Philip Burris, CGeol**

As a Qualified Person of the Technical Report on the Mangazeisky Silver Project, Republic of Sakha (Yakutia), Russian Federation, I, Philip Burris, do hereby certify:

- I am a Technical Director (Hydrogeology) with Wardell Armstrong International, with a business address at Baldhu House, Wheal Jane Earth Science Park, Baldhu, Truro, Cornwall, United Kingdom TR3 6EH.
- This certificate applies to the technical report entitled “NI 43-101 Technical Report Mangazeisky Silver Project MRE Update and Strategy Re-Assessment, Republic of Sakha (Yakutia), Russian Federation” dated 10<sup>th</sup> November 2021 (the “Technical Report”).
- I am a graduate of the University of Leeds (BSc (Hons) Geology, 1990, and University of New South Wales, Australia (MSc Hydrogeology, 1992). I have practiced my profession continuously since 1992. During my employment as a hydrogeologist I have undertaken over 100 mining studies worldwide assessing hydrogeology, surface water, risk assessment, water resources, in-pit water management, catchment analysis and integrated ESIA and feasibility studies .
- I have read the definition of “qualified person” set out in NI 43-101 (“the Instrument”) and certify that by reason of my education, affiliation with a professional association and past relevant work experience, I fulfil the requirements of a “Qualified Person” for the purposes of the Instrument.
- I am a member in good standing of the Geological Society of London as a Fellow and Chartered Geologist.
- I have not personally inspected the Property that is the subject of this Technical Report.
- I am responsible for Item 1.4, 16.2, and 25.3 of the Technical Report.
- I am independent of Silver Bear Resources plc. as defined by Section 1.5 of the Instrument.
- I have no prior involvement with the Property that is the subject of this Technical Report.
- I have read the Instrument and Form 43-101F1, and the Technical Report has been prepared in compliance with NI 43-101 and Form 43-101F1.
- As of the effective date of this certificate, to the best of my knowledge, information, and belief, the sections of Technical Report that I am responsible for contain all scientific and technical information that is required to be disclosed to make the Technical Report not misleading.

Dated this 10<sup>th</sup> day of November 2021

**(Signed & Sealed) Philip Burris**

Philip Burris  
BSc. (Hons), MSc., CGeol, FGS

**Alison Allen, CEnv**

As a Qualified Person of the Technical Report on the Mangazeisky Silver Project, Republic of Sakha (Yakutia), Russian Federation, I, Alison Brianna Allen, do hereby certify that:

- I am a Technical Director (Environmental and Social) of Wardell Armstrong International Ltd Wheal Jane, Baldhu, Truro, TR3 6EH, United Kingdom.
- This certificate applies to the technical report entitled “NI 43-101 Technical Report Mangazeisky Silver Project MRE Update and Strategy Re-Assessment, Republic of Sakha (Yakutia), Russian Federation” dated 10<sup>th</sup> November 2021 (the “Technical Report”).
- I graduated with a Bachelor of Science Degree in Natural Sciences from the University of East Anglia (UK) in 2001 and a Master of Science Degree in Mining Environmental Management from the Camborne School of Mines (UK) in 2008.
- I am a Fellow of the Institute of Materials, Minerals and Mining (Membership No. 474370), and Chartered Environmentalist of the Institute of Environmental Management and Assessment (Membership No. 0013685), and Full Member of the Institute of Ecology and Environmental Management.
- I have practiced my profession continuously for the last 21 years in a variety of countries and geological environments and have prepared Environmental and Social Chapters and Impact Assessments for precious and base metals..
- I have read the definition of “qualified person” set out in National Instrument 43-101 (“NI 43-101”) and certify that I am a “qualified person” for the purposes of NI 43-101.
- I have not personally inspected the Property that is the subject of this Technical Report.
- I am responsible for Item 20 of the Technical Report.
- I am independent of Silver Bear Resources plc. as defined by NI 43-101.
- I have no prior involvement with the Property that is the subject of this Technical Report.
- I have read the Instrument and Form 43-101F1, and the Technical Report has been prepared in compliance with NI 43-101 and Form 43-101F1.
- As of the effective date of this certificate, to the best of my knowledge, information, and belief, the sections of Technical Report that I am responsible for contain all scientific and technical information that is required to be disclosed to make the Technical Report not misleading.

Dated this 10<sup>th</sup> day of November, 2021

**(Signed & Sealed) Alison Allen**

Alison Allen  
BSc, MSc, CEnv, FIMMM, MIEMA, MIEEM

**Nikolai Shatkov, MAIG**

As a Qualified Person of the Technical Report on the Mangazeisky Silver Project, Republic of Sakha (Yakutia), Russian Federation, I, Nikolai Shatkov, do hereby certify:

- I am a Leading Geologist-Expert with, with a business address at 153 Leninsky Pr., Saint Petersburg, Russia.
- This certificate applies to the technical report entitled “NI 43-101 Technical Report Mangazeisky Silver Project MRE Update and Strategy Re-Assessment, Republic of Sakha (Yakutia), Russian Federation” dated 10<sup>th</sup> November 2021 (the “Technical Report”).
- I am a graduate of Leningrad State University, Department of Geology (1987) and PhD in Geology and Mineralogy at the A.P. Karpinsky Russian Institute of Geological Research (VSEGEI, 1997). I have practiced my profession continuously since July 1987. During my employment as a leading geologist I have frequently authored or reviewed for a variety of commodities, including precious metals with a particular focus on exploration, mineral resource evaluation, and project development.
- I have read the definition of “qualified person” set out in NI 43-101 (“the Instrument”) and certify that by reason of my education, affiliation with a professional association and past relevant work experience, I fulfil the requirements of a “Qualified Person” for the purposes of the Instrument.
- I am a registered member in good standing of the Australian Institute of Geoscientists (AIG) (# 6263.).
- I completed a personal inspection of the Property that is the subject of this Technical Report on 30<sup>th</sup> October 2021.
- I am responsible for Items 2.2.1, and 12.3 of the Technical Report.
- I am independent of Silver Bear Resources plc. as defined by Section 1.5 of the Instrument.
- I have no prior involvement with the Property that is the subject of this Technical Report.
- I have read the Instrument and Form 43-101F1, and the Technical Report has been prepared in compliance with NI 43-101 and Form 43-101F1.
- As of the effective date of this certificate, to the best of my knowledge, information, and belief, the sections of Technical Report that I am responsible for contain all scientific and technical information that is required to be disclosed to make the Technical Report not misleading.

Dated this 10<sup>th</sup> day of November 2021

**(Signed & Sealed) Nikolai Shatkov**

Nikolai Shatkov  
PhD in Geology, MAIG

## **APPENDIX 1: VERTIKALNY - QUANTILE ANALYSIS**



Quantile Analysis of Silver Grades for Individual Zones								
Zone	Q%_from	Q%_to	Qty of samples	Ave	Min	Max	Accumulated metal	Accumulated metal (%)
1	0	10	107	39.66	4.20	62.00	4 243.44	0.40
1	10	20	108	78.10	62.00	96.23	8 434.98	0.79
1	20	30	108	119.32	96.80	143.00	12 886.53	1.21
1	30	40	107	199.23	143.43	264.00	21 317.16	2.00
1	40	50	108	335.33	264.08	415.02	36 215.42	3.39
1	50	60	108	525.45	416.35	638.80	56 748.70	5.32
1	60	70	107	832.90	641.50	1 024.10	89 120.68	8.35
1	70	80	108	1 286.68	1 025.00	1 551.00	138 961.10	13.02
1	80	90	108	1 980.38	1 567.00	2 627.41	213 880.87	20.05
1	90	100	108	4 491.80	2 650.10	11 832.50	485 114.01	45.47
1	90	91	10	2 722.68	2 650.10	2 865.34	27 226.77	2.55
1	91	92	11	2 993.57	2 934.70	3 060.77	32 929.24	3.09
1	92	93	11	3 203.13	3 085.00	3 340.00	35 234.45	3.30
1	93	94	11	3 424.88	3 366.50	3 481.50	37 673.67	3.53
1	94	95	11	3 591.89	3 495.63	3 808.00	39 510.75	3.70
1	95	96	10	3 976.01	3 816.00	4 235.00	39 760.12	3.73
1	96	97	11	4 598.66	4 257.00	4 860.00	50 585.23	4.74
1	97	98	11	5 126.21	4 861.25	5 546.00	56 388.36	5.29
1	98	99	11	6 229.79	5 765.16	6 804.63	68 527.66	6.42
1	99	100	11	8 843.43	6 844.76	11 832.50	97 277.76	9.12
1	0	100	1 077	990.64	4.20	11 832.50	1 066 922.89	100
2	0	10	52	11.04	-	28.10	574.31	0.25
2	10	20	52	58.10	28.83	73.87	3 021.00	1.32
2	20	30	52	85.57	74.25	98.20	4 449.51	1.94
2	30	40	52	112.64	98.60	130.50	5 857.09	2.56
2	40	50	52	155.62	131.00	185.00	8 092.00	3.54
2	50	60	52	216.50	185.00	246.75	11 258.21	4.92
2	60	70	52	330.04	248.15	409.00	17 162.26	7.50
2	70	80	52	515.53	409.95	634.00	26 807.39	11.72
2	80	90	52	856.54	659.00	1 179.50	44 540.26	19.46
2	90	100	52	2 058.90	1 194.00	5 185.00	107 062.85	46.79
2	90	91	5	1 208.20	1 194.00	1 224.50	6 041.01	2.64
2	91	92	5	1 309.86	1 259.20	1 335.50	6 549.32	2.86
2	92	93	5	1 386.64	1 350.50	1 424.00	6 933.22	3.03
2	93	94	5	1 494.90	1 432.25	1 549.50	7 474.50	3.27
2	94	95	6	1 665.01	1 587.95	1 712.00	9 990.09	4.37
2	95	96	5	1 776.93	1 720.50	1 825.70	8 884.63	3.88
2	96	97	5	2 105.07	2 053.00	2 173.20	10 525.36	4.60
2	97	98	5	2 311.11	2 219.89	2 475.00	11 555.55	5.05
2	98	99	5	2 850.57	2 574.04	3 525.80	14 252.84	6.23
2	99	100	6	4 142.72	3 691.00	5 185.00	24 856.34	10.86
2	0	100	520	440.05	-	5 185.00	228 824.88	100
3	0	10	5	24.15	5.99	54.65	120.73	0.47
3	10	20	6	85.00	67.35	111.20	510.01	1.97
3	20	30	5	140.82	112.00	155.75	704.11	2.72
3	30	40	6	198.53	183.00	209.00	1 191.20	4.60
3	40	50	5	221.70	213.00	226.00	1 108.50	4.28

3	50	60	6	306.91	271.67	330.00	1 841.47	7.11
3	60	70	5	408.78	341.00	570.50	2 043.88	7.89
3	70	80	6	668.65	585.20	796.08	4 011.90	15.49
3	80	90	5	938.26	801.60	1 090.00	4 691.30	18.12
3	90	100	6	1 612.12	1 275.00	2 229.18	9 672.69	37.35
3	91	92	1	1 275.00	1 275.00	1 275.00	1 275.00	4.92
3	93	94	1	1 444.50	1 444.50	1 444.50	1 444.50	5.58
3	94	95	1	1 490.00	1 490.00	1 490.00	1 490.00	5.75
3	96	97	1	1 549.01	1 549.01	1 549.01	1 549.01	5.98
3	98	99	1	1 685.00	1 685.00	1 685.00	1 685.00	6.51
3	99	100	1	2 229.18	2 229.18	2 229.18	2 229.18	8.61
3	0	100	55	470.83	5.99	2 229.18	25 895.78	100
4	0	10	9	39.14	4.55	80.00	352.22	0.69
4	10	20	9	97.43	87.68	110.67	876.83	1.73
4	20	30	9	128.63	114.91	139.90	1 157.69	2.28
4	30	40	9	185.80	140.00	244.00	1 672.17	3.30
4	40	50	9	292.94	267.92	339.06	2 636.46	5.20
4	50	60	9	391.43	341.18	434.28	3 522.91	6.94
4	60	70	9	512.73	443.00	624.00	4 614.58	9.09
4	70	80	9	799.88	645.78	901.54	7 198.95	14.19
4	80	90	9	1 087.54	940.94	1 342.50	9 787.88	19.29
4	90	100	9	2 102.18	1 429.61	2 839.94	18 919.59	37.29
4	91	92	1	1 429.61	1 429.61	1 429.61	1 429.61	2.82
4	92	93	1	1 442.16	1 442.16	1 442.16	1 442.16	2.84
4	93	94	1	1 643.89	1 643.89	1 643.89	1 643.89	3.24
4	94	95	1	1 980.89	1 980.89	1 980.89	1 980.89	3.90
4	95	96	1	1 987.00	1 987.00	1 987.00	1 987.00	3.92
4	96	97	1	2 309.00	2 309.00	2 309.00	2 309.00	4.55
4	97	98	1	2 559.98	2 559.98	2 559.98	2 559.98	5.05
4	98	99	1	2 727.12	2 727.12	2 727.12	2 727.12	5.37
4	99	100	1	2 839.94	2 839.94	2 839.94	2 839.94	5.60
4	0	100	90	563.77	4.55	2 839.94	50 739.28	100
5	0	10	1	80.74	80.74	80.74	80.74	2.42
5	10	20	1	108.00	108.00	108.00	108.00	3.23
5	20	30	1	118.99	118.99	118.99	118.99	3.56
5	30	40	2	195.00	171.00	219.00	390.00	11.67
5	40	50	1	234.00	234.00	234.00	234.00	7.00
5	50	60	1	235.50	235.50	235.50	235.50	7.05
5	60	70	2	244.98	241.00	248.96	489.96	14.66
5	70	80	1	248.96	248.96	248.96	248.96	7.45
5	80	90	1	376.20	376.20	376.20	376.20	11.26
5	90	100	2	530.00	530.00	530.00	1 060.00	31.71
5	94	95	1	530.00	530.00	530.00	530.00	15.86
5	99	100	1	530.00	530.00	530.00	530.00	15.86
5	0	100	13	257.10	80.74	530.00	3 342.35	100
6	0	10	3	54.97	52.00	57.91	164.91	1.31
6	10	20	3	66.10	64.00	67.29	198.29	1.57
6	20	30	4	88.21	68.83	102.00	352.83	2.79
6	30	40	3	113.09	102.00	125.00	339.26	2.69
6	40	50	4	155.41	128.65	170.00	621.65	4.92
6	50	60	3	186.73	176.20	192.00	560.20	4.44

6	60	70	3	281.49	268.12	305.36	844.48	6.69
6	70	80	4	384.60	314.58	477.01	1 538.41	12.19
6	80	90	3	681.87	490.52	802.40	2 045.62	16.20
6	90	100	4	1 489.95	881.00	2 450.20	5 959.80	47.20
6	92	93	1	881.00	881.00	881.00	881.00	6.98
6	94	95	1	1 154.70	1 154.70	1 154.70	1 154.70	9.15
6	97	98	1	1 473.90	1 473.90	1 473.90	1 473.90	11.67
6	99	100	1	2 450.20	2 450.20	2 450.20	2 450.20	19.41
6	0	100	34	371.34	52.00	2 450.20	12 625.45	100
7	10	20	1	3.00	3.00	3.00	3.00	0.09
7	30	40	1	243.80	243.80	243.80	243.80	7.55
7	50	60	1	304.00	304.00	304.00	304.00	9.41
7	70	80	1	1 090.00	1 090.00	1 090.00	1 090.00	33.74
7	90	100	1	1 590.00	1 590.00	1 590.00	1 590.00	49.21
7	99	100	1	1 590.00	1 590.00	1 590.00	1 590.00	49.21
7	0	100	5	646.16	3.00	1 590.00	3 230.80	100
8	10	20	1	106.77	106.77	106.77	106.77	7.72
8	30	40	1	122.00	122.00	122.00	122.00	8.82
8	50	60	1	198.80	198.80	198.80	198.80	14.37
8	70	80	1	366.40	366.40	366.40	366.40	26.49
8	90	100	1	589.00	589.00	589.00	589.00	42.59
8	99	100	1	589.00	589.00	589.00	589.00	42.59
8	0	100	5	276.59	106.77	589.00	1 382.97	100
9	10	20	1	87.00	87.00	87.00	87.00	4.80
9	20	30	1	89.80	89.80	89.80	89.80	4.95
9	30	40	1	96.50	96.50	96.50	96.50	5.32
9	40	50	1	143.00	143.00	143.00	143.00	7.88
9	60	70	1	169.00	169.00	169.00	169.00	9.32
9	70	80	1	215.50	215.50	215.50	215.50	11.88
9	80	90	1	243.60	243.60	243.60	243.60	13.43
9	90	100	1	769.50	769.50	769.50	769.50	42.42
9	99	100	1	769.50	769.50	769.50	769.50	42.42
9	0	100	8	226.74	87.00	769.50	1 813.90	100

Quantile Analysis of Lead Grades for Individual Zones								
Zone	Q%_from	Q%_to	Qty of samples	Ave	Min	Max	Accumulated metal	Accumulated metal (%)
1	0	10	86	0.03	-	0.08	2.78	0.17
1	10	20	87	0.11	0.08	0.15	9.51	0.59
1	20	30	86	0.19	0.15	0.24	16.56	1.02
1	30	40	87	0.30	0.24	0.37	26.25	1.62
1	40	50	86	0.46	0.38	0.56	39.47	2.44
1	50	60	87	0.70	0.56	0.88	61.25	3.78
1	60	70	86	1.08	0.88	1.34	93.31	5.76
1	70	80	87	1.73	1.34	2.26	150.84	9.31
1	80	90	86	3.16	2.27	4.47	272.04	16.79
1	90	100	87	10.90	4.61	28.29	948.56	58.53
1	90	91	8	4.79	4.61	4.98	38.30	2.36
1	91	92	9	5.21	5.00	5.35	46.86	2.89
1	92	93	9	5.80	5.49	6.30	52.19	3.22
1	93	94	8	6.96	6.39	7.54	55.66	3.43
1	94	95	9	7.96	7.57	8.77	71.67	4.42
1	95	96	9	10.20	9.10	11.12	91.84	5.67
1	96	97	8	12.17	11.32	13.12	97.32	6.01
1	97	98	9	14.58	13.34	15.64	131.26	8.10
1	98	99	9	16.98	16.16	18.15	152.78	9.43
1	99	100	9	23.41	18.27	28.29	210.68	13.00
1	0	100	865	1.87	-	28.29	1 620.56	100
2	0	10	37	0.07	0.01	0.11	2.58	0.39
2	10	20	38	0.17	0.11	0.23	6.57	0.99
2	20	30	38	0.30	0.24	0.36	11.38	1.72
2	30	40	37	0.45	0.37	0.54	16.70	2.53
2	40	50	38	0.68	0.55	0.86	25.89	3.92
2	50	60	38	0.99	0.87	1.12	37.74	5.71
2	60	70	37	1.28	1.12	1.50	47.26	7.15
2	70	80	38	1.87	1.50	2.46	71.05	10.75
2	80	90	38	3.34	2.47	4.59	127.10	19.23
2	90	100	38	8.29	4.79	19.83	314.85	47.62
2	90	91	3	4.85	4.79	4.90	14.54	2.20
2	91	92	4	5.35	4.90	5.60	21.42	3.24
2	92	93	4	5.83	5.63	5.91	23.31	3.53
2	93	94	4	6.23	6.10	6.45	24.92	3.77
2	94	95	4	6.86	6.48	7.33	27.43	4.15
2	95	96	3	7.81	7.71	7.90	23.43	3.54
2	96	97	4	8.42	8.14	8.60	33.67	5.09
2	97	98	4	9.07	8.90	9.21	36.27	5.49
2	98	99	4	10.71	10.18	11.57	42.83	6.48
2	99	100	4	16.76	14.47	19.83	67.03	10.14
2	0	100	377	1.75	0.01	19.83	661.12	100
3	0	10	4	0.02	0.01	0.06	0.10	0.05
3	10	20	4	0.51	0.41	0.64	2.06	1.07
3	20	30	5	0.90	0.70	1.05	4.48	2.32
3	30	40	4	1.25	1.14	1.40	5.02	2.60
3	40	50	5	2.19	1.40	2.86	10.94	5.66
3	50	60	4	3.21	2.91	3.47	12.86	6.65

3	60	70	4	4.08	3.76	4.35	16.30	8.44
3	70	80	5	6.68	5.03	7.62	33.38	17.27
3	80	90	4	9.74	9.10	10.80	38.97	20.17
3	90	100	5	13.83	10.88	16.50	69.13	35.78
3	91	92	1	10.88	10.88	10.88	10.88	5.63
3	93	94	1	12.65	12.65	12.65	12.65	6.55
3	95	96	1	12.70	12.70	12.70	12.70	6.57
3	97	98	1	16.40	16.40	16.40	16.40	8.49
3	99	100	1	16.50	16.50	16.50	16.50	8.54
3	0	100	44	4.39	0.01	16.50	193.23	100
4	0	10	7	0.05	-	0.10	0.33	0.35
4	10	20	8	0.15	0.11	0.20	1.22	1.32
4	20	30	8	0.24	0.21	0.27	1.96	2.11
4	30	40	8	0.33	0.27	0.42	2.66	2.87
4	40	50	8	0.51	0.44	0.56	4.09	4.41
4	50	60	8	0.62	0.56	0.68	4.95	5.34
4	60	70	8	0.79	0.70	0.92	6.30	6.79
4	70	80	8	1.31	0.96	1.62	10.52	11.34
4	80	90	8	2.38	1.86	3.17	19.01	20.49
4	90	100	8	5.22	3.25	9.18	41.74	44.99
4	91	92	1	3.25	3.25	3.25	3.25	3.50
4	92	93	1	3.38	3.38	3.38	3.38	3.64
4	93	94	1	3.42	3.42	3.42	3.42	3.68
4	94	95	1	3.93	3.93	3.93	3.93	4.23
4	96	97	1	4.84	4.84	4.84	4.84	5.22
4	97	98	1	6.43	6.43	6.43	6.43	6.93
4	98	99	1	7.33	7.33	7.33	7.33	7.90
4	99	100	1	9.18	9.18	9.18	9.18	9.89
4	0	100	79	1.17	-	9.18	92.78	100
5	10	20	1	0.01	0.01	0.01	0.01	0.09
5	20	30	1	0.08	0.08	0.08	0.08	0.75
5	30	40	1	0.23	0.23	0.23	0.23	2.14
5	40	50	1	0.23	0.23	0.23	0.23	2.14
5	50	60	1	0.27	0.27	0.27	0.27	2.50
5	60	70	1	0.67	0.67	0.67	0.67	6.25
5	70	80	1	2.80	2.80	2.80	2.80	26.10
5	80	90	1	3.22	3.22	3.22	3.22	30.01
5	90	100	1	3.22	3.22	3.22	3.22	30.01
5	99	100	1	3.22	3.22	3.22	3.22	30.01
5	0	100	9	1.19	0.01	3.22	10.73	100
6	0	10	3	-	-	-	-	-
6	10	20	3	0.02	-	0.04	0.07	0.07
6	20	30	3	0.04	0.04	0.05	0.13	0.12
6	30	40	3	0.10	0.08	0.13	0.29	0.28
6	40	50	4	0.19	0.15	0.29	0.77	0.75
6	50	60	3	0.36	0.31	0.39	1.09	1.06
6	60	70	3	0.67	0.42	0.87	2.01	1.96
6	70	80	3	3.76	3.11	4.16	11.27	11.01
6	80	90	3	7.23	4.93	9.57	21.68	21.18
6	90	100	4	16.27	12.01	18.90	65.06	63.56
6	92	93	1	12.01	12.01	12.01	12.01	11.74

6	94	95	1	16.91	16.91	16.91	16.91	16.52
6	97	98	1	17.24	17.24	17.24	17.24	16.84
6	99	100	1	18.90	18.90	18.90	18.90	18.46
6	0	100	32	3.20	-	18.90	102.36	100
7	10	20	1	0.01	0.01	0.01	0.01	1.52
7	30	40	1	0.14	0.14	0.14	0.14	20.94
7	50	60	1	0.15	0.15	0.15	0.15	23.37
7	70	80	1	0.17	0.17	0.17	0.17	25.34
7	90	100	1	0.19	0.19	0.19	0.19	28.83
7	99	100	1	0.19	0.19	0.19	0.19	28.83
7	0	100	5	0.13	0.01	0.19	0.66	100
8	10	20	1	0.36	0.36	0.36	0.36	1.35
8	30	40	1	0.42	0.42	0.42	0.42	1.57
8	50	60	1	4.76	4.76	4.76	4.76	17.91
8	70	80	1	6.20	6.20	6.20	6.20	23.32
8	90	100	1	14.85	14.85	14.85	14.85	55.86
8	99	100	1	14.85	14.85	14.85	14.85	55.86
8	0	100	5	5.32	0.36	14.85	26.58	100
9	10	20	1	0.07	0.07	0.07	0.07	1.20
9	30	40	1	0.11	0.11	0.11	0.11	1.88
9	50	60	1	0.49	0.49	0.49	0.49	8.39
9	70	80	1	0.69	0.69	0.69	0.69	11.82
9	90	100	1	4.48	4.48	4.48	4.48	76.71
9	99	100	1	4.48	4.48	4.48	4.48	76.71
9	0	100	5	1.17	0.07	4.48	5.84	100

Quantile Analysis of Zinc Grades for Individual Zones								
Zone	Q%_from	Q%_to	Qty of samples	Ave	Min	Max	Accumulated metal	Accumulated metal (%)
1	0	10	86	0.11	-	0.26	9.15	0.59
1	10	20	87	0.40	0.26	0.54	34.64	2.24
1	20	30	86	0.70	0.54	0.83	59.78	3.86
1	30	40	87	0.96	0.84	1.09	83.88	5.42
1	40	50	86	1.21	1.10	1.35	104.25	6.74
1	50	60	87	1.50	1.36	1.65	130.59	8.44
1	60	70	86	1.81	1.65	1.96	155.43	10.04
1	70	80	87	2.19	1.96	2.44	190.32	12.30
1	80	90	86	2.86	2.44	3.58	246.11	15.90
1	90	100	87	6.13	3.60	13.26	533.71	34.48
1	90	91	8	3.69	3.60	3.74	29.48	1.90
1	91	92	9	4.08	3.76	4.26	36.71	2.37
1	92	93	9	4.37	4.30	4.48	39.37	2.54
1	93	94	8	4.78	4.49	4.98	38.27	2.47
1	94	95	9	5.30	5.08	5.60	47.71	3.08
1	95	96	9	5.83	5.62	6.09	52.46	3.39
1	96	97	8	6.48	6.21	7.02	51.86	3.35
1	97	98	9	7.38	7.06	7.61	66.38	4.29
1	98	99	9	8.42	7.65	9.10	75.81	4.90
1	99	100	9	10.63	9.35	13.26	95.67	6.18
1	0	100	865	1.79	-	13.26	1 547.86	100
2	0	10	37	0.12	0.03	0.20	4.43	0.57
2	10	20	38	0.27	0.20	0.33	10.18	1.32
2	20	30	38	0.41	0.35	0.46	15.56	2.02
2	30	40	37	0.54	0.47	0.61	19.89	2.58
2	40	50	38	0.71	0.62	0.81	27.16	3.52
2	50	60	38	1.05	0.82	1.26	39.93	5.17
2	60	70	37	1.51	1.31	1.80	55.91	7.24
2	70	80	38	2.31	1.83	2.89	87.83	11.38
2	80	90	38	4.09	2.95	5.35	155.51	20.14
2	90	100	38	9.36	5.37	21.18	355.72	46.07
2	90	91	3	5.53	5.37	5.71	16.58	2.15
2	91	92	4	5.86	5.76	6.00	23.44	3.04
2	92	93	4	6.43	6.13	6.66	25.71	3.33
2	93	94	4	6.93	6.69	7.08	27.73	3.59
2	94	95	4	7.25	7.20	7.31	29.00	3.76
2	95	96	3	7.60	7.35	7.74	22.79	2.95
2	96	97	4	8.25	7.75	8.82	33.01	4.27
2	97	98	4	9.55	9.19	10.54	38.20	4.95
2	98	99	4	14.87	12.99	18.40	59.47	7.70
2	99	100	4	19.95	18.79	21.18	79.80	10.33
2	0	100	377	2.05	0.03	21.18	772.12	100
3	0	10	4	0.09	0.03	0.15	0.38	0.36
3	10	20	4	0.29	0.16	0.37	1.14	1.10
3	20	30	5	0.41	0.37	0.49	2.06	1.98
3	30	40	4	0.60	0.55	0.67	2.42	2.32
3	40	50	5	0.77	0.68	0.83	3.83	3.68
3	50	60	4	0.87	0.83	0.95	3.48	3.34

3	60	70	4	1.16	0.98	1.28	4.63	4.45
3	70	80	5	1.47	1.30	1.70	7.33	7.03
3	80	90	4	2.02	1.75	2.29	8.07	7.74
3	90	100	5	14.16	2.37	18.10	70.82	68.00
3	91	92	1	2.37	2.37	2.37	2.37	2.28
3	93	94	1	16.50	16.50	16.50	16.50	15.84
3	95	96	1	16.85	16.85	16.85	16.85	16.18
3	97	98	1	17.00	17.00	17.00	17.00	16.32
3	99	100	1	18.10	18.10	18.10	18.10	17.38
3	0	100	44	2.37	0.03	18.10	104.15	100
4	0	10	7	0.04	-	0.09	0.25	0.11
4	10	20	8	0.27	0.13	0.43	2.18	0.95
4	20	30	8	0.72	0.60	0.84	5.76	2.50
4	30	40	8	0.95	0.84	1.03	7.60	3.29
4	40	50	8	1.20	1.04	1.29	9.63	4.17
4	50	60	8	1.59	1.37	1.95	12.72	5.51
4	60	70	8	2.33	1.97	2.57	18.61	8.06
4	70	80	8	3.21	2.69	3.92	25.69	11.13
4	80	90	8	6.59	4.21	8.19	52.74	22.85
4	90	100	8	11.95	8.40	17.70	95.61	41.43
4	91	92	1	8.40	8.40	8.40	8.40	3.64
4	92	93	1	8.44	8.44	8.44	8.44	3.66
4	93	94	1	9.27	9.27	9.27	9.27	4.02
4	94	95	1	11.01	11.01	11.01	11.01	4.77
4	96	97	1	11.14	11.14	11.14	11.14	4.83
4	97	98	1	12.78	12.78	12.78	12.78	5.54
4	98	99	1	16.88	16.88	16.88	16.88	7.31
4	99	100	1	17.70	17.70	17.70	17.70	7.67
4	0	100	79	2.92	-	17.70	230.79	100
5	10	20	1	0.42	0.42	0.42	0.42	3.62
5	20	30	1	0.78	0.78	0.78	0.78	6.78
5	30	40	1	1.01	1.01	1.01	1.01	8.79
5	40	50	1	1.01	1.01	1.01	1.01	8.79
5	50	60	1	1.04	1.04	1.04	1.04	9.05
5	60	70	1	1.16	1.16	1.16	1.16	10.09
5	70	80	1	1.80	1.80	1.80	1.80	15.66
5	80	90	1	1.80	1.80	1.80	1.80	15.66
5	90	100	1	2.48	2.48	2.48	2.48	21.57
5	99	100	1	2.48	2.48	2.48	2.48	21.57
5	0	100	9	1.28	0.42	2.48	11.50	100
6	0	10	3	-	-	-	-	-
6	10	20	3	0.37	-	0.72	1.12	2.15
6	20	30	3	1.02	0.72	1.17	3.05	5.85
6	30	40	3	1.24	1.22	1.27	3.73	7.16
6	40	50	4	1.37	1.28	1.43	5.47	10.50
6	50	60	3	1.55	1.48	1.59	4.64	8.90
6	60	70	3	1.68	1.59	1.81	5.04	9.68
6	70	80	3	1.87	1.87	1.87	5.61	10.77
6	80	90	3	2.92	2.49	3.43	8.76	16.81
6	90	100	4	3.67	3.44	3.89	14.69	28.19
6	92	93	1	3.44	3.44	3.44	3.44	6.60



6	94	95	1	3.66	3.66	3.66	3.66	7.02
6	97	98	1	3.70	3.70	3.70	3.70	7.10
6	99	100	1	3.89	3.89	3.89	3.89	7.46
6	0	100	32	1.63	-	3.89	52.12	100
7	10	20	1	0.01	0.01	0.01	0.01	0.58
7	30	40	1	0.27	0.27	0.27	0.27	19.32
7	50	60	1	0.30	0.30	0.30	0.30	21.98
7	70	80	1	0.33	0.33	0.33	0.33	24.00
7	90	100	1	0.47	0.47	0.47	0.47	34.12
7	99	100	1	0.47	0.47	0.47	0.47	34.12
7	0	100	5	0.28	0.01	0.47	1.38	100
8	10	20	1	0.38	0.38	0.38	0.38	2.59
8	30	40	1	1.54	1.54	1.54	1.54	10.46
8	50	60	1	4.03	4.03	4.03	4.03	27.47
8	70	80	1	4.20	4.20	4.20	4.20	28.60
8	90	100	1	4.53	4.53	4.53	4.53	30.87
8	99	100	1	4.53	4.53	4.53	4.53	30.87
8	0	100	5	2.93	0.38	4.53	14.67	100
9	10	20	1	0.19	0.19	0.19	0.19	3.97
9	30	40	1	0.19	0.19	0.19	0.19	3.97
9	50	60	1	0.55	0.55	0.55	0.55	11.50
9	70	80	1	0.71	0.71	0.71	0.71	14.85
9	90	100	1	3.14	3.14	3.14	3.14	65.70
9	99	100	1	3.14	3.14	3.14	3.14	65.70
9	0	100	5	0.96	0.19	3.14	4.78	100

**APPENDIX 2: VERTIKALNY – JORC TABLE 1**

## Section 1 Sampling Techniques and Data

Criteria	JORC Code explanation	Commentary
<b>Sampling techniques</b>	<ul style="list-style-type: none"> <li>• <i>Nature and quality of sampling (eg cut channels, random chips, or specific specialised industry standard measurement tools appropriate to the minerals under investigation, such as down hole gamma sondes, or handheld XRF instruments, etc). These examples should not be taken as limiting the broad meaning of sampling.</i></li> <li>• <i>Include reference to measures taken to ensure sample representivity and the appropriate calibration of any measurement tools or systems used.</i></li> <li>• <i>Aspects of the determination of mineralisation that are Material to the Public Report.</i></li> <li>• <i>In cases where ‘industry standard’ work has been done this would be relatively simple (eg ‘reverse circulation drilling was used to obtain 1 m samples from which 3 kg was pulverised to produce a 30 g charge for fire assay’). In other cases more explanation may be required, such as where there is coarse gold that has inherent sampling problems. Unusual commodities or mineralisation types (eg submarine nodules) may warrant disclosure of detailed information.</i></li> </ul>	<p><b>Exploration Campaign 2005-2018</b></p> <ul style="list-style-type: none"> <li>• Sampling was carried out using a combination of diamond core drillholes and surface trench channel samples.</li> <li>• Diamond drilling was used to obtain predominantly 1.0m samples (minimum length 0.25m to a maximum of 3.00m) that were subsequently cut in half along its length to produce half core for sample preparation (crushing/pulverising) to produce a final sub-sample for laboratory analysis.</li> <li>• Trenching was used to obtain predominately 1.0m samples (minimum length 0.10m to a maximum of 2.00m). The entire sample was taken for sample preparation (crushing/pulverising) to produce a final sub-sample for laboratory analysis.</li> </ul>
<b>Drilling techniques</b>	<ul style="list-style-type: none"> <li>• <i>Drill type (eg core, reverse circulation, open-hole hammer, rotary air blast, auger, Bangka, sonic, etc) and details (eg core diameter, triple or standard tube, depth of diamond tails, face-sampling bit or other type, whether core is oriented and if so, by what method, etc).</i></li> </ul>	<ul style="list-style-type: none"> <li>• Drilling at Vertikalny consists of diamond core drilling only.</li> <li>• In the majority of drillholes, the core was oriented at the commencement of every run to allow structural measurements to be made and all holes are subject to down-hole survey at generally 20.0m intervals.</li> <li>• Data from HQ (63.5mm) and NQ (47.6mm) wireline</li> </ul>

Criteria	JORC Code explanation	Commentary
		<p>diamond drillholes is used for interpretation and grade estimation. The predominate drilling diameter was of HQ size.</p> <ul style="list-style-type: none"> <li>The main drill campaigns at Vertikalny have taken place in 2005-2015 with no drilling in 2010.</li> <li>Metallurgical holes were drilled in 2017</li> <li>Grade control drilling was carried out in 2018.</li> <li>A total of 304 diamond holes have been drilled for 44,060m.</li> </ul>
<b>Drill sample recovery</b>	<ul style="list-style-type: none"> <li><i>Method of recording and assessing core and chip sample recoveries and results assessed.</i></li> <li><i>Measures taken to maximise sample recovery and ensure representative nature of the samples.</i></li> <li><i>Whether a relationship exists between sample recovery and grade and whether sample bias may have occurred due to preferential loss/gain of fine/coarse material.</i></li> </ul>	<ul style="list-style-type: none"> <li>WAI is not aware of any specific measures taken to reduce losses through drilling or that any drilling campaign suffered from poor recovery.</li> <li>Diamond drill recovery averages approximately 95%.</li> <li>Due to good drilling practices followed at Vertikalny samples are considered homogenous and representative.</li> <li>No apparent relationship is observed between sample recovery and grade.</li> </ul>
<b>Logging</b>	<ul style="list-style-type: none"> <li><i>Whether core and chip samples have been geologically and geotechnically logged to a level of detail to support appropriate Mineral Resource estimation, mining studies and metallurgical studies.</i></li> <li><i>Whether logging is qualitative or quantitative in nature. Core (or costean, channel, etc) photography.</i></li> <li><i>The total length and percentage of the relevant intersections logged.</i></li> </ul>	<ul style="list-style-type: none"> <li>Core was logged on site by company geological personnel using a standardised logging convention, to a level sufficient to support geological interpretation, modelling, and subsequent mineral resource estimation.</li> <li>Core was geologically logged including a description of lithology, alteration/weathering, major structures, mineralisation, and veining on a qualitative basis.</li> <li>Core was logged manually before transfer to an electronic system using Excel spreadsheets.</li> <li>Rock Quality Designation (RQD) measurements were also completed by the field geologists.</li> </ul>

Criteria	JORC Code explanation	Commentary
<b>Sub-sampling techniques and sample preparation</b>	<ul style="list-style-type: none"> <li>• <i>If core, whether cut or sawn and whether quarter, half or all core taken.</i></li> <li>• <i>If non-core, whether riffled, tube sampled, rotary split, etc. and whether sampled wet or dry.</i></li> <li>• <i>For all sample types, the nature, quality and appropriateness of the sample preparation technique.</i></li> <li>• <i>Quality control procedures adopted for all sub-sampling stages to maximise representativity of samples.</i></li> <li>• <i>Measures taken to ensure that the sampling is representative of the in-situ material collected, including for instance results for field duplicate/second-half sampling.</i></li> <li>• <i>Whether sample sizes are appropriate to the grain size of the material being sampled.</i></li> </ul>	<ul style="list-style-type: none"> <li>• Sample preparation has followed standard industry practices: <ul style="list-style-type: none"> <li>– Diamond drill core was cut lengthways along its long axis with half core used for primary analysis and the other half retained for reference purposes.</li> <li>– Trench channel samples was cut by portable diamond saw and collected using hammer and chisel.</li> </ul> </li> <li>• Sample preparation for Vertikalny was carried out on site. The sample preparation flowsheet comprised: <ul style="list-style-type: none"> <li>– Two stage crushing to 85% passing 1mm;</li> <li>– Split to 1kg sample;</li> <li>– Submit for further analysis.</li> </ul> </li> <li>• Prior 2011 final milling and pulverising to 85% passing 75µm was carried out in Chemical Laboratory of State Enterprise Aldangeologia in Aldan (Russia) and later in ALS Chemex in Chita, Russia.</li> <li>• Sub-sampling quality control has been maintained through use of company SOP's being adopted to ensure consistency by following a standard set of practices throughout the process.</li> <li>• The use of field duplicate sample (1/4 of core or parallel channel sample next to original trench sample) analysis has been used throughout the drill campaign at Vertikalny in order to monitor precision and reproducibility.</li> </ul>
<b>Quality of assay data and laboratory tests</b>	<ul style="list-style-type: none"> <li>• <i>The nature, quality and appropriateness of the assaying and laboratory procedures used and whether the technique is considered partial or total.</i></li> <li>• <i>For geophysical tools, spectrometers, handheld XRF</i></li> </ul>	<ul style="list-style-type: none"> <li>• No geophysical or portable analysis tools were used to determine assay values stored in the final exploration database used for mineral resource estimation.</li> <li>• For the diamond drillhole and trench channel samples,</li> </ul>

Criteria	JORC Code explanation	Commentary
	<p><i>instruments, etc, the parameters used in determining the analysis including instrument make and model, reading times, calibrations factors applied and their derivation, etc.</i></p> <ul style="list-style-type: none"> <li>• <i>Nature of quality control procedures adopted (eg standards, blanks, duplicates, external laboratory checks) and whether acceptable levels of accuracy (ie lack of bias) and precision have been established.</i></li> </ul>	<p>QA/QC results (from duplicate and standard samples) were in line with expectations for precision and accuracy. Certified reference material (CRM) samples were obtained from Geostats Pty Ltd (Australia), ORE Research &amp; Exploration Pty Ltd (Australia), OJSC Irgiredmet (Russia) and LLC “NTC Minstandart” (Russia).</p> <ul style="list-style-type: none"> <li>• Local non-mineralised rock used for blank samples. Approximately 10% of blank samples were found to be out of range. Approximately 1.5% of blank samples had significant grade, i.e. &gt;50g/t Ag.</li> <li>• Prior 2011 samples sent for spectral assay for 36 elements. Samples with significant Ag grade determined by spectral assay were analysed for Ag, Cu, Pb and Zn using atomic absorption. In addition, all analysis was conducted for Ag using fire assay.</li> <li>• From 2011 onwards, analyses were completed using a four acid sample digestion of 0.25g, followed by ICP finish and reporting of 33 elements (laboratory code ME-ICP62). Where values of silver, lead and zinc exceed upper detection limits further four acid digestion analyses were carried out of 0.4g followed by ICP finish (lab code ME-OG62). Where values of silver exceeded the upper detection limit (1,500g/t), a 50g sample was taken for FA analysis with gravimetric finish (lab code Ag-GRA22).</li> <li>• The assays of Certified Reference Material, which cover a range of metal values for each of Ag, as well as field duplicate assays show no significant bias.</li> <li>• No systematic bias appears to be present in results.</li> <li>• The quality control and assurance data reviewed by the CP indicates the assays are generally within expected</li> </ul>

Criteria	JORC Code explanation	Commentary
		limits. The CP is satisfied the quality assurance and control data is sufficient to support the Mineral Resource classification presented herein.
<b>Verification of sampling and assaying</b>	<ul style="list-style-type: none"> <li>• <i>The verification of significant intersections by either independent or alternative company personnel.</i></li> <li>• <i>The use of twinned holes.</i></li> <li>• <i>Documentation of primary data, data entry procedures, data verification, data storage (physical and electronic) protocols.</i></li> <li>• <i>Discuss any adjustment to assay data.</i></li> </ul>	<ul style="list-style-type: none"> <li>• All work has been supervised by senior technical staff.</li> <li>• Significant intersections have not been verified by either independent or alternate company personnel.</li> <li>• Logging data in the first instance was recorded by hand to form documentation for each hole that includes collar and down hole survey information and assay information once available. This information was subsequently transferred to an electronic database.</li> <li>• WAI completed a number of checks on the raw data and data entry process. Based on the verification work completed, WAI is confident that the compiled database is an accurate reflection of the available drilling data.</li> <li>• No adjustments to assay data have been made.</li> </ul>
<b>Location of data points</b>	<ul style="list-style-type: none"> <li>• <i>Accuracy and quality of surveys used to locate drill holes (collar and down-hole surveys), trenches, mine workings and other locations used in Mineral Resource estimation.</i></li> <li>• <i>Specification of the grid system used.</i></li> <li>• <i>Quality and adequacy of topographic control.</i></li> </ul>	<ul style="list-style-type: none"> <li>• All data was supplied in the World Geodetic System 1984, Zone 36J Northern Hemisphere (UTM).</li> <li>• Collar positions for all holes were laid out by the on-site surveyor using a differential GPS and then checked again once drilling was completed.</li> <li>• Downhole surveys were carried out for all of the diamond drillholes using Reflex Ez-Shot equipment. The measurement was taken every 20m in general.</li> <li>• A topographic survey was conducted in 2014. The survey was carried out using Topcon 5GR satellite receiver. The field data was processed using TOPCONTOOLS software package. This survey is used for the current Mineral Resource Estimate.</li> </ul>

Criteria	JORC Code explanation	Commentary
		<ul style="list-style-type: none"> <li>The small differences between the GPS readings and the topographical survey data do not influence the interpreted mineralisation widths.</li> </ul>
<b>Data spacing and distribution</b>	<ul style="list-style-type: none"> <li><i>Data spacing for reporting of Exploration Results.</i></li> <li><i>Whether the data spacing and distribution is sufficient to establish the degree of geological and grade continuity appropriate for the Mineral Resource and Ore Reserve estimation procedure(s) and classifications applied.</i></li> <li><i>Whether sample compositing has been applied.</i></li> </ul>	<ul style="list-style-type: none"> <li>Data spacing is down to 40m x 40m in the central part of deposit with some area of infill drilling to 25m x 25m. On the flanks the data spacing is more generally between 80m x 80m. The grade control trenches are developed every 10m on the each 5m bench. This spacing is sufficient to establish geological and mineralisation continuity appropriate for the reporting of Mineral Resources.</li> <li>Mineral Resources are classified as Measured, Indicated and Inferred in accordance with the guidelines of the JORC Code (2012), and through geostatistical analysis considering the spatial distribution of sample data.</li> <li>Sample compositing was carried out as part of the mineral resource estimation process.</li> <li>The diamond drill and trench data spacing is deemed by the CP to be sufficient to imply/confirm geological and grade continuity, sufficient for the classification of Inferred resources only.</li> <li>The average length of the samples is 0.91m therefore the composite length of 1.0m was chosen.</li> </ul>
<b>Orientation of data in relation to geological structure</b>	<ul style="list-style-type: none"> <li><i>Whether the orientation of sampling achieves unbiased sampling of possible structures and the extent to which this is known, considering the deposit type.</i></li> <li><i>If the relationship between the drilling orientation and the orientation of key mineralised structures is considered to have introduced a sampling bias, this</i></li> </ul>	<ul style="list-style-type: none"> <li>In general, drilling is carried out so that the intersections of holes with mineralised zones occurs at a high angle which results in limited sample bias.</li> <li>The general strike of mineralisation is north-west at 310° with sub-vertical steeply dipping mineralisation zone hence drilling is generally inclined at -50-60° towards the strike of the zones.</li> </ul>



Criteria	JORC Code explanation	Commentary
	<i>should be assessed and reported if material.</i>	<ul style="list-style-type: none"> <li>Intercepts are reported as apparent thicknesses except where otherwise stated.</li> </ul>
<b>Sample security</b>	<ul style="list-style-type: none"> <li><i>The measures taken to ensure sample security.</i></li> </ul>	<ul style="list-style-type: none"> <li>Samples were transported to site sample preparation facilities. After initial crushing and splitting approximately 1kg material was prepared for further assay.</li> <li>Crushed samples were transported regularly (typically monthly during the drilling campaigns) by commercial carrier to ALS lab in Chita in sealed bags.</li> <li>After preparation in the field, samples were packed into bags and dispatched to the freight forwarders directly by the Company. All bags were transported by the Company directly to the sample preparation/assay laboratory. The assay laboratory audits the samples on arrival and reports any discrepancies back to the Company.</li> <li>Sample security was managed by the Company. The CP was not able to inspect the sample dispatches and relies on the Company's representative to ensure that no discrepancies occurred, and the chain of custody is acceptable.</li> </ul>
<b>Audits or reviews</b>	<ul style="list-style-type: none"> <li><i>The results of any audits or reviews of sampling techniques and data.</i></li> </ul>	<ul style="list-style-type: none"> <li>Previous audits were completed by Tetra Tech in 2016/17 who considered that the drill program, logging and sampling procedures are consistent with recognised industry best practices and are considered adequate for this type of deposit.</li> <li>Tetra Tech checked 10% of the assay certificates against the values contained within the database. No errors were encountered.</li> <li>With regards blank samples/material, it was concluded that the blank material probably contained minor</li> </ul>

Criteria	JORC Code explanation	Commentary
		<p>mineralisation, and it was recommended that the material used for blank samples is re-examined or replaced by material known not to carry any target mineralisation. Commercially-sourced certified blank material would be recommended to eliminate any possibility of minor mineralisation. It was also recommended that the sample preparation apparatus is flushed with a quartz sand wash between samples. Blank samples were also independently assessed for each campaign, and were found to be well within acceptable limits.</p>

## Section 2 Reporting of Exploration Results

Criteria	JORC Code explanation	Commentary
<b>Mineral tenement and land tenure status</b>	<ul style="list-style-type: none"> <li>Type, reference name/number, location and ownership including agreements or material issues with third parties such as joint ventures, partnerships, overriding royalties, native title interests, historical sites, wilderness or national park and environmental settings.</li> <li>The security of the tenure held at the time of reporting along with any known impediments to obtaining a license to operate in the area.</li> </ul>	<ul style="list-style-type: none"> <li>The Vertikalny license is located in the north of Kobyakskiy district in the central of Republic Sakha (Yakutia), Russia, some 400km to the north of Yakutsk city, the Republic capital, and centred on coordinates 65°40'N, 130°07'E.</li> <li>CSJC Prognoz is in possession of a mining licence with the reference YaKU 03626 BE. The license has an expiry date of 01.09.2033 and covers an area of 13.55 km<sup>2</sup>.</li> <li>WAI is not aware of any known impediments to obtaining and maintaining a licence to operate the Vertikalny Property.</li> <li>The CP has relied on the information provided by SBR that the tenement is in good standing and all fees are paid.</li> </ul>
<b>Exploration done by other parties</b>	<ul style="list-style-type: none"> <li>Acknowledgment and appraisal of exploration by other parties.</li> </ul>	<ul style="list-style-type: none"> <li>The first mention of the presence of silver-base metal mineralisation is related to 1764. Following that up until 1930s individuals were carried out prospecting and small-scale mining in the area.</li> <li>Sporadic exploration was carried out during 1930s and 1940s.</li> <li>Different scale geological mapping and soil-geochemistry sampling as well as different ground and airborne geophysical survey methods was carried out in 1950s to 1970s. More detailed prospecting works had been carried out on the areas with detected metal anomalies.</li> <li>From 1991 to 2003 JSC Yanageologia completed 151,452m<sup>3</sup> of trenching and 1,303m of drilling focusing on the 15 principal veins systems.</li> </ul>

Criteria	JORC Code explanation	Commentary
		<ul style="list-style-type: none"> <li>Prospecting/exploration activities include surface trenching, a restricted amount of drilling and underground developments (shallow shafts and adits with crosscuts).</li> <li>CJSC Prognoz has carried out exploration at Vertikalny since 2004 up to present.</li> </ul>
<b>Geology</b>	<ul style="list-style-type: none"> <li><i>Deposit type, geological setting and style of mineralisation.</i></li> </ul>	<ul style="list-style-type: none"> <li>The Vertikalny Property is part of Endybal area which occurs in the north-eastern wing of Kuranakh anticlinorium and being a part of Zapadno-Verkhoyanskiy mega-anticlinorium. The Endybal area is composed by terrigenous sediments of Carboniferous-Triassic age. The sediments intruded by Late Jurassic, Early and Late Cretaceous magmatic rock.</li> <li>The mineralisation is associated with crestal plane of Endybal anticline. South-north striking Newktominskiy fault and transverse Severo-Tirekhtyaxskiy deep fault are associated with crestal of Endybal anticline.</li> <li>Mineralisation of Vertikalny is related to the feather structures of this faults having north-west strike with steep dipping to north-east.</li> <li>Vertikalny is a vein type deposit representing combination of conjugated faults and brecciated sections and associated mineralisation.</li> <li>Mineralised zones are grouped into three domains – Central, North-East and North-West areas.</li> <li>Mineralisation is epigenetic polymetallic silver-lead-zinc veins hosted by metasediment.</li> </ul>
<b>Drill hole Information</b>	<ul style="list-style-type: none"> <li><i>A summary of all information material to the understanding of the exploration results including a tabulation of the following</i></li> </ul>	<ul style="list-style-type: none"> <li>Exploration data held in the database and used in the mineral resource estimate can be summarised as</li> </ul>

Criteria	JORC Code explanation	Commentary
	<p><i>information for all Material drill holes:</i></p> <ul style="list-style-type: none"> <li>○ <i>easting and northing of the drill hole collar</i></li> <li>○ <i>elevation or RL (Reduced Level – elevation above sea level in metres) of the drill hole collar</i></li> <li>○ <i>dip and azimuth of the hole</i></li> <li>○ <i>down hole length and interception depth</i></li> <li>○ <i>hole length.</i></li> </ul> <ul style="list-style-type: none"> <li>● <i>If the exclusion of this information is justified on the basis that the information is not Material and this exclusion does not detract from the understanding of the report, the Competent Person should clearly explain why this is the case.</i></li> </ul>	<p>follows:</p> <ul style="list-style-type: none"> <li>– Number of drillholes – 304;</li> <li>– Number of exploration trenches – 74;</li> <li>– Number of grade control trenches – 210;</li> <li>– East collar ranges – 548,350m to 552,450m</li> <li>– North collar ranges – 7,286,050m to 7,282,820m</li> <li>– Collar elevation ranges – 529.3m to 1,247.6m</li> <li>– Azimuth ranges – 0° to 360°</li> <li>– Dip ranges –90° to +90°</li> <li>– Length of holes/trenches – 2.54m to 496m</li> </ul> <ul style="list-style-type: none"> <li>● Both diamond drillhole and trench information and assay results were used in the Mineral Resource Estimation.</li> </ul>
<b>Data aggregation methods</b>	<ul style="list-style-type: none"> <li>● <i>In reporting Exploration Results, weighting averaging techniques, maximum and/or minimum grade truncations (eg cutting of high grades) and cut-off grades are usually Material and should be stated.</i></li> <li>● <i>Where aggregate intercepts incorporate short lengths of high-grade results and longer lengths of low-grade results, the procedure used for such aggregation should be stated and some typical examples of such aggregations should be shown in detail.</i></li> <li>● <i>The assumptions used for any reporting of metal equivalent values should be clearly stated.</i></li> </ul>	<ul style="list-style-type: none"> <li>● Top cutting was used during the mineral resource estimation process to reduce the potential for outlier grades to have an overbearing effect on estimated block grades. Top cutting is based on decile analysis and log probability graphs for all zones and applied to Ag, Pb and Zn (detailed in the main body of the text).</li> <li>● No metal equivalent equations were used during the mineral resource estimation procedure or reporting.</li> <li>● Samples were composited to 1m lengths during the mineral resource estimation procedure to ensure a consistent level of support during the estimation process.</li> </ul>
<b>Relationship between mineralisation</b>	<ul style="list-style-type: none"> <li>● <i>These relationships are particularly important in the reporting of Exploration Results.</i></li> <li>● <i>If the geometry of the mineralisation with respect to the drill hole angle is known, its nature should be reported.</i></li> </ul>	<ul style="list-style-type: none"> <li>● The nature of the main zones of mineralisation at Vertikalny is well recognised as being steeply dipping narrow vein structures.</li> <li>● In general, drilling is carried out so that the intersections</li> </ul>

Criteria	JORC Code explanation	Commentary
<b>widths and intercept lengths</b>	<ul style="list-style-type: none"> <li>If it is not known and only the down hole lengths are reported, there should be a clear statement to this effect (eg 'down hole length, true width not known').</li> </ul>	<ul style="list-style-type: none"> <li>of holes with mineralised zones occurs at a high angle to minimise sample bias.</li> <li>Down hole length reflects drilled meters not the true width of the mineralised structures.</li> </ul>
<b>Diagrams</b>	<ul style="list-style-type: none"> <li>Appropriate maps and sections (with scales) and tabulations of intercepts should be included for any significant discovery being reported. These should include, but not be limited to a plan view of drill hole collar locations and appropriate sectional views.</li> </ul>	<ul style="list-style-type: none"> <li>Appropriate data tabulations, plans and sections showing the nature of the mineralisation, exploration and final mineral resource estimate are included in the main body of the report.</li> </ul>
<b>Balanced reporting</b>	<ul style="list-style-type: none"> <li>Where comprehensive reporting of all Exploration Results is not practicable, representative reporting of both low and high grades and/or widths should be practiced to avoid misleading reporting of Exploration Results.</li> </ul>	<ul style="list-style-type: none"> <li>Individual exploration results are not being reported. This section is not considered relevant to the overall reporting of the mineral resource estimate.</li> <li>A total of 304 diamond drillholes and 284 trenches (including grade control trenches) have been completed on the Vertikalny and used for the current mineral resource estimate.</li> </ul>
<b>Other substantive exploration data</b>	<ul style="list-style-type: none"> <li>Other exploration data, if meaningful and material, should be reported including (but not limited to): geological observations; geophysical survey results; geochemical survey results; bulk samples – size and method of treatment; metallurgical test results; bulk density, groundwater, geotechnical and rock characteristics; potential deleterious or contaminating substances.</li> </ul>	<ul style="list-style-type: none"> <li>Metallurgical testwork was used to define recovery factors during pit optimisation used as a basis for limiting potential Mineral Resources based on the expectation of economic extraction.</li> <li>Geotechnical data of Vertikalny deposit was used during pit optimisation used as a basis for limiting potential Mineral Resources based on the expectation of economic extraction.</li> <li>Density measurement was done for both oxide and primary mineralisation as following: <ul style="list-style-type: none"> <li>144 samples in 2004-2012;</li> <li>88 samples in 2012;</li> <li>53 samples in 2015.</li> </ul> </li> </ul>

Criteria	JORC Code explanation	Commentary
<b>Further work</b>	<ul style="list-style-type: none"> <li>The nature and scale of planned further work (eg tests for lateral extensions or depth extensions or large-scale step-out drilling).</li> <li>Diagrams clearly highlighting the areas of possible extensions, including the main geological interpretations and future drilling areas, provided this information is not commercially sensitive.</li> </ul>	<ul style="list-style-type: none"> <li>No planned exploration drilling is currently known about.</li> <li>Mineralisation is closed along strike to north-west and south-east.</li> <li>Mineralisation is not closed at depth.</li> </ul>

### Section 3 Estimation and Reporting of Mineral Resources

Criteria	JORC Code explanation	Commentary
<b>Database integrity</b>	<ul style="list-style-type: none"> <li>Measures taken to ensure that data has not been corrupted by, for example, transcription or keying errors, between its initial collection and its use for Mineral Resource estimation purposes.</li> <li>Data validation procedures used.</li> </ul>	<ul style="list-style-type: none"> <li>The project database is held in MS Access and Excel format files. Data held includes; collar location, downhole surveys, assay information, lithological logging and oxidation logging. Also held in Microsoft Excel spreadsheets is information on duplicate samples certified reference materials and blanks.</li> <li>Access to the Vertikalny drilling/trenching database used for resource estimation is restricted to geological and selected technical staff.</li> <li>WAI completed a number of checks on the raw data supplied by CJSC Prognoz and is satisfied that the data does not contain significant errors nor has it been corrupted.</li> <li>Validation of the database was carried out during import of the data in to Datamine Studio 3 for production of the mineral resource estimate, no major issues were found with duplicate or overlapping samples.</li> </ul>
<b>Site visits</b>	<ul style="list-style-type: none"> <li>Comment on any site visits undertaken by the Competent Person and the outcome of those visits.</li> <li>If no site visits have been undertaken indicate</li> </ul>	<ul style="list-style-type: none"> <li>A site visit was undertaken by Nikolai Shatkov (MAIG) on 30<sup>th</sup> October 2021.</li> <li>The site visits included inspection of the current open pit operations, processing plant, inspection of current drilling, a visit to the core shed</li> </ul>

Criteria	JORC Code explanation	Commentary
	<i>why this is the case.</i>	(core cutting and sample preparation), logging facilities, on-site laboratory, and discussions with senior and key geological staff to verify the data collection and management.
<b>Geological interpretation</b>	<ul style="list-style-type: none"> <li>• <i>Confidence in (or conversely, the uncertainty of) the geological interpretation of the mineral deposit.</i></li> <li>• <i>Nature of the data used and of any assumptions made.</i></li> <li>• <i>The effect, if any, of alternative interpretations on Mineral Resource estimation.</i></li> <li>• <i>The use of geology in guiding and controlling Mineral Resource estimation.</i></li> <li>• <i>The factors affecting continuity both of grade and geology.</i></li> </ul>	<ul style="list-style-type: none"> <li>• Grade estimation for Vertikalny uses diamond and trench sampling only.</li> <li>• The confidence in the geological interpretation is deemed good. Exploration drilling has been carried out on a grid down to 40m x 40m, with wider spacing on the flanks - between 80m and 100m, and geological logging is comprehensive.</li> <li>• Geological logging has been carried out from drill core samples and in trenches.</li> <li>• Geological logging was used to define mineralised domains within the overall resource model.</li> <li>• The wireframes used to constrain the block model and grade interpolation were constructed based on Prognoz's understanding of the geology and mineralisation of the Vertikalny deposit.</li> <li>• The resource model reflects the interpretation north-west orientated vein system (zones) reflecting areas of elevated mineralisation.</li> </ul>
<b>Dimensions</b>	<ul style="list-style-type: none"> <li>• <i>The extent and variability of the Mineral Resource expressed as length (along strike or otherwise), plan width, and depth below surface to the upper and lower limits of the Mineral Resource.</i></li> </ul>	<ul style="list-style-type: none"> <li>• The mineralisation is split on three domains which have north-west. The overall mineralisation dimension is ~3.5km in north-west direction and ~50-80m across strike.</li> <li>• The current mineral resource is constrained by series of optimised open pit with a total strike length of 3.5km, a maximum width of ≈200m at the crest, and a maximum depth of pit = 130m.</li> <li>• The unconstrained block model has a maximum depth of mineralisation up to 400m from the surface.</li> </ul>



Criteria	JORC Code explanation	Commentary
<b>Estimation and modelling techniques</b>	<ul style="list-style-type: none"> <li>• <i>The nature and appropriateness of the estimation technique(s) applied and key assumptions, including treatment of extreme grade values, domaining, interpolation parameters and maximum distance of extrapolation from data points. If a computer assisted estimation method was chosen include a description of computer software and parameters used.</i></li> <li>• <i>The availability of check estimates, previous estimates and/or mine production records and whether the Mineral Resource estimate takes appropriate account of such data.</i></li> <li>• <i>The assumptions made regarding recovery of by-products.</i></li> <li>• <i>Estimation of deleterious elements or other non-grade variables of economic significance (eg sulphur for acid mine drainage characterisation).</i></li> <li>• <i>In the case of block model interpolation, the block size in relation to the average sample spacing and the search employed.</i></li> <li>• <i>Any assumptions behind modelling of selective mining units.</i></li> <li>• <i>Any assumptions about correlation between variables.</i></li> <li>• <i>Description of how the geological interpretation was used to control the resource estimates.</i></li> <li>• <i>Discussion of basis for using or not using grade cutting or capping.</i></li> <li>• <i>The process of validation, the checking process</i></li> </ul>	<ul style="list-style-type: none"> <li>• Three domains were created to represent each of the mineralised structures (zones).</li> <li>• DTM surfaces were created to represent the pre-mining topographical surface, pit contours as on 31<sup>st</sup> of May 2019, overburden material and base of oxide/primary material.</li> <li>• A block model was created using the geological and mineralised zone wireframes as boundaries. A parent block size of 10m (X) x 10m (Y) x 10m (Z) was used in the block model with key fields established for geological and mineralised domains. Additional key fields were established to denote oxide/fresh rock domains, mined out material and overburden rock.</li> <li>• Grade capping: Grade capping was carried out to stop local overestimation of grade from high-grade outlier samples. Grade capping was used for all variables on a zone-by-zone basis where outlier grades were identified using a combination of decile analysis and a review of log-probability plots.</li> <li>• Composites: A 1m composite length was chosen to ensure consistent sample support during estimation. Composites were limited to the boundaries of mineralised domains.</li> <li>• Variography: A variographic study by domain identified reasonably robust variogram models for Ag across two mineralised zones.</li> <li>• Estimation: Estimation was carried out using Ordinary Kriging as the primary method. An Inverse distance (squared) estimate was carried out for validation purposes. Only composite samples within an individual zone were used for estimation of that zone. Estimation parameters were based on models of grade continuity produced during geostatistical analysis. Dynamic anisotropy was used to change orientations of search ellipses based on local variations of dip and strike. Minimum and maximum sample criteria, an octant search restriction, and restrictions of number of composite samples from a</li> </ul>

Criteria	JORC Code explanation	Commentary
	<i>used, the comparison of model data to drill hole data, and use of reconciliation data if available.</i>	<p>single drillhole were employed during grade estimation to assist with declustering and to reduce local grade bias. A multiple pass estimation as carried out with expanding search ellipses and less restrictive estimation parameters for estimating blocks in more poorly sampled areas.</p> <ul style="list-style-type: none"> <li>• Estimation was carried out into parent cells only to reduce risk of conditional bias. Estimation was carried out using a discretisation of five points in each dimension.</li> <li>• The block model was verified first by comparing drillhole composite sample values with estimated block values on a sectional and plan basis. Grade comparison was also carried out statistically by zone to ensure the global grade estimate was unbiased. Grade profile (swath) plots were also constructed to compare modelled grades and input composite grades in slices or varying width. During this process a comparison was made between declustered and clustered data to identify any possible local bias introduced by irregular grade spacing.</li> <li>• No estimation of deleterious components was carried out.</li> <li>• The estimated block model was validated by visual inspection of block grades in comparison with drillhole data, and comparison of the block model statistics.</li> </ul>
<b>Moisture</b>	<ul style="list-style-type: none"> <li>• <i>Whether the tonnages are estimated on a dry basis or with natural moisture, and the method of determination of the moisture content.</i></li> </ul>	<ul style="list-style-type: none"> <li>• All tonnages are reported as dry tonnages.</li> <li>• Moisture content has been measured using weighing waxed samples and dried ones.</li> </ul>
<b>Cut-off parameters</b>	<ul style="list-style-type: none"> <li>• <i>The basis of the adopted cut-off grade(s) or quality parameters applied.</i></li> </ul>	<ul style="list-style-type: none"> <li>• Mineralised zones are defined at a natural cut-off grade of 50g/t Ag.</li> <li>• The mineral resource estimate is restricted to material falling within an NPV Scheduler optimised pit shell as described below in “Mining factors or assumptions”, and above a cut-off grade representing breakeven cut-off grade derived from open pit optimisation</li> </ul>

Criteria	JORC Code explanation	Commentary
		parameters for each zone (Oxide and Fresh).
<b>Mining factors or assumptions</b>	<ul style="list-style-type: none"> <li>Assumptions made regarding possible mining methods, minimum mining dimensions and internal (or, if applicable, external) mining dilution. It is always necessary as part of the process of determining reasonable prospects for eventual economic extraction to consider potential mining methods, but the assumptions made regarding mining methods and parameters when estimating Mineral Resources may not always be rigorous. Where this is the case, this should be reported with an explanation of the basis of the mining assumptions made.</li> </ul>	<ul style="list-style-type: none"> <li>The deposit is an operating open pit mine. Part of the deposit below pit is deemed to be mined by underground.</li> <li>Reporting of mineral resources suitable for open pit extraction were limited by the creation of an optimised open pit shell in NPV Scheduler. The optimisation was carried out using Net Smelter Return data. The approach to NSR estimation is presented in the main text body. The pit shell was created with the following major parameters: <ul style="list-style-type: none"> <li>NSR (oxide) – US\$/t 172.78;</li> <li>NSR (primary) – US\$/t – 139.06;</li> <li>Mining cost (mineralisation/waste) of US\$2.53/t;</li> <li>Oxide processing cost of US\$72.91/t;</li> <li>Primary processing cost US\$46.97/t</li> <li>Processing recovery – 95%;</li> <li>G&amp;A cost of US\$60.0/t</li> <li>Slope angle - 56° at hanging wall, 48° at foot wall;</li> <li>Mining dilution of 30% and mining losses of 0%.</li> </ul> </li> <li>Reporting of mineral resources for underground mining is based on the following parameters: <ul style="list-style-type: none"> <li>NSR (primary only) – US\$162.00/t;</li> <li>Mining cost – US\$55/t;</li> <li>Processing cost – US\$46.97/t;</li> <li>G&amp;A – US\$60.00/t</li> <li>Processing recovery – 95%.</li> </ul> </li> </ul>
<b>Metallurgical factors or assumptions</b>	<ul style="list-style-type: none"> <li>The basis for assumptions or predictions regarding metallurgical amenability. It is always necessary as part of the process of determining reasonable prospects for eventual economic</li> </ul>	<ul style="list-style-type: none"> <li>Metallurgical recovery was utilised during the construction of an optimised pit shell used for limiting mineral resources based on an expectation of eventual economic extraction.</li> </ul>

Criteria	JORC Code explanation	Commentary
	<p><i>extraction to consider potential metallurgical methods, but the assumptions regarding metallurgical treatment processes and parameters made when reporting Mineral Resources may not always be rigorous. Where this is the case, this should be reported with an explanation of the basis of the metallurgical assumptions made.</i></p>	
<p><b>Environmental factors or assumptions</b></p>	<ul style="list-style-type: none"> <li>Assumptions made regarding possible waste and process residue disposal options. It is always necessary as part of the process of determining reasonable prospects for eventual economic extraction to consider the potential environmental impacts of the mining and processing operation. While at this stage the determination of potential environmental impacts, particularly for a greenfields project, may not always be well advanced, the status of early consideration of these potential environmental impacts should be reported. Where these aspects have not been considered this should be reported with an explanation of the environmental assumptions made.</li> </ul>	<ul style="list-style-type: none"> <li>WAI is unaware of any environmental factors which would preclude the reporting of Mineral Resources.</li> </ul>
<p><b>Bulk density</b></p>	<ul style="list-style-type: none"> <li>Whether assumed or determined. If assumed, the basis for the assumptions. If determined, the method used, whether wet or dry, the frequency of the measurements, the nature, size and representativeness of the samples.</li> <li>The bulk density for bulk material must have been measured by methods that adequately account</li> </ul>	<ul style="list-style-type: none"> <li>Density measurements have been taken for oxide and primary material with respect to natural moisture.</li> <li>A total of 285 density measurements have been taken for oxide and primary material.</li> <li>Measurements were made using the Archimedes water immersion method, the results were recorded and imported into Excel spreadsheet.</li> </ul>

Criteria	JORC Code explanation	Commentary
	<p><i>for void spaces (vugs, porosity, etc), moisture and differences between rock and alteration zones within the deposit.</i></p> <ul style="list-style-type: none"> <li>• <i>Discuss assumptions for bulk density estimates used in the evaluation process of the different materials.</i></li> </ul>	<ul style="list-style-type: none"> <li>• Density was assigned to the block model during the Mineral Resource estimation by applying the 3.13 t/m<sup>3</sup> value for oxide material 3.56t/m<sup>3</sup> for primary material and 2.75 for waste.</li> <li>• Moisture content was measured for oxide and primary material.</li> <li>• The tonnage is reported on a dry basis.</li> </ul>
<b>Classification</b>	<ul style="list-style-type: none"> <li>• <i>The basis for the classification of the Mineral Resources into varying confidence categories.</i></li> <li>• <i>Whether appropriate account has been taken of all relevant factors (ie relative confidence in tonnage/grade estimations, reliability of input data, confidence in continuity of geology and metal values, quality, quantity and distribution of the data).</i></li> <li>• <i>Whether the result appropriately reflects the Competent Person's view of the deposit.</i></li> </ul>	<ul style="list-style-type: none"> <li>• Mineral Resource classification was carried out in accordance with the guidelines of the JORC Code (2012) to Measured, Indicated and Inferred.</li> <li>• The Vertikalny Silver Project is an operating mine. Classification is based on sample density, confidence in geological continuity and mineralisation continuity, and reliability of the exploration database used as basis of mineral resource estimation: <ul style="list-style-type: none"> <li>– Measured classification was assigned to the areas drillhole spacing was 40m x 40m and lower;</li> <li>– Indicated classification was assigned to the areas where drillhole spacing was 80m x 80m or below;</li> <li>– Inferred classification was assigned to the areas where drillhole spacing was greater than 80m x 80m or if the mineralisation continuity was not established.</li> </ul> </li> <li>• The mineral resource estimate classification reflects the Competent Person's view of the Vertikalny Project.</li> <li>• Mineral Resources for open pit mining were limited using an optimised pit shell using parameters as laid out in the main section of the report and as described in "Mining factors and assumptions" above.</li> <li>• Mineral Resources for underground operation was defined below open pit shell.</li> <li>• The mineral resource estimate has been limited to the surveyed pit surface as detailed in the main report.</li> </ul>

Criteria	JORC Code explanation	Commentary
<b>Audits or reviews</b>	<ul style="list-style-type: none"> <li>The results of any audits or reviews of Mineral Resource estimates.</li> </ul>	<ul style="list-style-type: none"> <li>WAI is not aware of any audits or reviews of this Mineral Resource Estimate other than internal peer review.</li> </ul>
<b>Discussion of relative accuracy/confidence</b>	<ul style="list-style-type: none"> <li>Where appropriate a statement of the relative accuracy and confidence level in the Mineral Resource estimate using an approach or procedure deemed appropriate by the Competent Person. For example, the application of statistical or geostatistical procedures to quantify the relative accuracy of the resource within stated confidence limits, or, if such an approach is not deemed appropriate, a qualitative discussion of the factors that could affect the relative accuracy and confidence of the estimate.</li> <li>The statement should specify whether it relates to global or local estimates, and, if local, state the relevant tonnages, which should be relevant to technical and economic evaluation. Documentation should include assumptions made and the procedures used.</li> <li>These statements of relative accuracy and confidence of the estimate should be compared with production data, where available.</li> </ul>	<ul style="list-style-type: none"> <li>The relative accuracy and confidence in the mineral resource estimate is reflected in the reporting of the mineral resource as set out in the JORC Code (2012)</li> <li>The statement relates to global estimates of tonnes and grade.</li> <li>The classification applied to the mineral resource estimate is based upon; confidence of continuity of mineralisation, quality of data (QA/QC) and validation of the block model.</li> </ul>

### **APPENDIX 3: MANGAZEISKY NORTH – JORC TABLE 1**

## Section 1 Sampling Techniques and Data

Criteria	JORC Code explanation	Commentary
<b>Sampling techniques</b>	<ul style="list-style-type: none"> <li>• <i>Nature and quality of sampling (eg cut channels, random chips, or specific specialised industry standard measurement tools appropriate to the minerals under investigation, such as down hole gamma sondes, or handheld XRF instruments, etc). These examples should not be taken as limiting the broad meaning of sampling.</i></li> <li>• <i>Include reference to measures taken to ensure sample representivity and the appropriate calibration of any measurement tools or systems used.</i></li> <li>• <i>Aspects of the determination of mineralisation that are Material to the Public Report.</i></li> <li>• <i>In cases where ‘industry standard’ work has been done this would be relatively simple (eg ‘reverse circulation drilling was used to obtain 1 m samples from which 3 kg was pulverised to produce a 30 g charge for fire assay’). In other cases more explanation may be required, such as where there is coarse gold that has inherent sampling problems. Unusual commodities or mineralisation types (eg submarine nodules) may warrant disclosure of detailed information.</i></li> </ul>	<p><b>Exploration Campaign 2013-2015</b></p> <ul style="list-style-type: none"> <li>• Sampling was carried out using a combination of diamond core drillholes and surface trench channel samples.</li> <li>• Diamond drilling was used to obtain predominantly 1.0m samples (minimum length 0.25m to a maximum of 3.00m) that were subsequently cut in half along its length to produce half core for sample preparation (crushing/pulverising) to produce a final sub-sample for laboratory analysis.</li> <li>• Trenching was used to obtain predominately 1.0m samples (minimum length 0.10m to a maximum of 2.00m). The entire sample was taken for sample preparation (crushing/pulverising) to produce a final sub-sample for laboratory analysis.</li> </ul>
<b>Drilling techniques</b>	<ul style="list-style-type: none"> <li>• <i>Drill type (eg core, reverse circulation, open-hole hammer, rotary air blast, auger, Bangka, sonic, etc) and details (eg core diameter, triple or standard tube, depth of diamond tails, face-sampling bit or other type, whether core is oriented and if so, by what method, etc).</i></li> </ul>	<ul style="list-style-type: none"> <li>• Drilling at North Mangazeisky (NM) consists of diamond core drilling only.</li> <li>• In the majority of drillholes, the core was oriented at the commencement of every run to allow structural measurements to be made and all holes are subject to down-hole survey at generally 20.0m intervals.</li> <li>• Data from HQ (63.5mm) and NQ (47.6mm) wireline</li> </ul>



Criteria	JORC Code explanation	Commentary
		<p>diamond drillholes is used for interpretation and grade estimation. The predominate drilling diameter was of HQ size.</p> <ul style="list-style-type: none"> <li>The main drill campaigns at NM have taken place in 2014-2016 including 29 holes to collect material for metallurgical testwork (2016).</li> <li>A total of 160 diamond holes have been drilled for 7,214m.</li> </ul>
<b>Drill sample recovery</b>	<ul style="list-style-type: none"> <li>Method of recording and assessing core and chip sample recoveries and results assessed.</li> <li>Measures taken to maximise sample recovery and ensure representative nature of the samples.</li> <li>Whether a relationship exists between sample recovery and grade and whether sample bias may have occurred due to preferential loss/gain of fine/coarse material.</li> </ul>	<ul style="list-style-type: none"> <li>WAI is not aware of any specific measures taken to reduce losses through drilling or that any drilling campaign suffered from poor recovery.</li> <li>Diamond drill recovery averages approximately 95%.</li> <li>Due to good drilling practices followed at NM samples are considered homogenous and representative.</li> <li>No apparent relationship is observed between sample recovery and grade.</li> </ul>
<b>Logging</b>	<ul style="list-style-type: none"> <li>Whether core and chip samples have been geologically and geotechnically logged to a level of detail to support appropriate Mineral Resource estimation, mining studies and metallurgical studies.</li> <li>Whether logging is qualitative or quantitative in nature. Core (or costean, channel, etc) photography.</li> <li>The total length and percentage of the relevant intersections logged.</li> </ul>	<ul style="list-style-type: none"> <li>Core was logged on site by company geological personnel using a standardised logging convention, to a level sufficient to support geological interpretation, modelling, and subsequent mineral resource estimation.</li> <li>Core was geologically logged including a description of lithology, alteration/weathering, major structures, mineralisation, and veining on a qualitative basis.</li> <li>Core was logged manually before transfer to an electronic system using Excel spreadsheets.</li> <li>Rock Quality Designation (RQD) measurements were also completed by the field geologists.</li> </ul>

Criteria	JORC Code explanation	Commentary
<p><b>Sub-sampling techniques and sample preparation</b></p>	<ul style="list-style-type: none"> <li>• <i>If core, whether cut or sawn and whether quarter, half or all core taken.</i></li> <li>• <i>If non-core, whether riffled, tube sampled, rotary split, etc. and whether sampled wet or dry.</i></li> <li>• <i>For all sample types, the nature, quality and appropriateness of the sample preparation technique.</i></li> <li>• <i>Quality control procedures adopted for all sub-sampling stages to maximise representivity of samples.</i></li> <li>• <i>Measures taken to ensure that the sampling is representative of the in situ material collected, including for instance results for field duplicate/second-half sampling.</i></li> <li>• <i>Whether sample sizes are appropriate to the grain size of the material being sampled.</i></li> </ul>	<ul style="list-style-type: none"> <li>• Sample preparation has followed standard industry practices:             <ul style="list-style-type: none"> <li>– Diamond drill core was cut lengthways along its long axis with half core used for primary analysis and the other half retained for reference purposes.</li> <li>– Trench channel samples was cut by portable diamond saw and collected using hammer and chisel.</li> </ul> </li> <li>• Sample preparation for Vertikalny was carried out on site. The sample preparation flowsheet comprised:             <ul style="list-style-type: none"> <li>– Two stage crushing to 85% passing 1mm;</li> <li>– Split to 1kg sample;</li> <li>– Submit for further analysis.</li> </ul> </li> <li>• Final milling and pulverising to 85% passing 75µm was carried out in ALS Chemex in Chita, Russia.</li> <li>• Sub-sampling quality control has been maintained through use of company SOP's being adopted to ensure consistency by following a standard set of practices throughout the process.</li> <li>• The use of field duplicate sample (1/4 of core or parallel channel sample next to original trench sample) analysis has been used throughout the drill campaign at NM in order to monitor precision and reproducibility.</li> </ul>
<p><b>Quality of assay data and laboratory tests</b></p>	<ul style="list-style-type: none"> <li>• <i>The nature, quality and appropriateness of the assaying and laboratory procedures used and whether the technique is considered partial or total.</i></li> <li>• <i>For geophysical tools, spectrometers, handheld XRF instruments, etc, the parameters used in determining the analysis including instrument make and model,</i></li> </ul>	<ul style="list-style-type: none"> <li>• No geophysical or portable analysis tools were used to determine assay values stored in the final exploration database used for mineral resource estimation.</li> <li>• For the diamond drillhole and trench channel samples, QA/QC results (from duplicate and standard samples) were in line with expectations for precision and</li> </ul>

Criteria	JORC Code explanation	Commentary
	<p><i>reading times, calibrations factors applied and their derivation, etc.</i></p> <ul style="list-style-type: none"> <li><i>Nature of quality control procedures adopted (eg standards, blanks, duplicates, external laboratory checks) and whether acceptable levels of accuracy (ie lack of bias) and precision have been established.</i></li> </ul>	<p>accuracy. Certified reference material (CRM) samples were obtained from Geostats Pty Ltd (Australia), OJSC Irgiredmet (Russia) and LLC “NTC Minstandart” (Russia).</p> <ul style="list-style-type: none"> <li>Local non-mineralised rock used for blank samples. Approximately 12% of blank samples were found to be out of range. Approximately 5% of blank samples had significant grade, i.e., &gt;50g/t Ag.</li> <li>Analyses were completed using a four-acid sample digestion of 0.25g, followed by ICP finish and reporting of 33 elements (laboratory code ME-ICP62). Where values of silver, lead and zinc exceed upper detection limits further four acid digestion analyses were carried out of 0.4g followed by ICP finish (lab code ME-OG62). Where values of silver exceeded the upper detection limit (1,500g/t), a 50g sample was taken for FA analysis with gravimetric finish (lab code Ag-GRA22).</li> <li>The assays of Certified Reference Material, which cover a range of metal values for each of Ag, as well as field duplicate assays show no significant bias.</li> <li>No systematic bias appears to be present in results.</li> <li>The quality control and assurance data reviewed by the CP indicates the assays are generally within expected limits. The CP is satisfied the quality assurance and control data is sufficient to support the Mineral Resource classification presented herein.</li> </ul>
<p><b>Verification of sampling and assaying</b></p>	<ul style="list-style-type: none"> <li><i>The verification of significant intersections by either independent or alternative company personnel.</i></li> <li><i>The use of twinned holes.</i></li> <li><i>Documentation of primary data, data entry</i></li> </ul>	<ul style="list-style-type: none"> <li>All work has been supervised by senior technical staff.</li> <li>Significant intersections have not been verified by either independent or alternate company personnel.</li> <li>Logging data in the first instance was recorded by hand</li> </ul>

Criteria	JORC Code explanation	Commentary
	<p><i>procedures, data verification, data storage (physical and electronic) protocols.</i></p> <ul style="list-style-type: none"> <li>• <i>Discuss any adjustment to assay data.</i></li> </ul>	<p>to form documentation for each hole that includes collar and down hole survey information and assay information once available. This information was subsequently transferred to an electronic database.</p> <ul style="list-style-type: none"> <li>• WAI completed a number of checks on the raw data and data entry process. Based on the verification work completed, WAI is confident that the compiled database is an accurate reflection of the available drilling data.</li> <li>• No adjustments to assay data have been made.</li> </ul>
<b>Location of data points</b>	<ul style="list-style-type: none"> <li>• <i>Accuracy and quality of surveys used to locate drill holes (collar and down-hole surveys), trenches, mine workings and other locations used in Mineral Resource estimation.</i></li> <li>• <i>Specification of the grid system used.</i></li> <li>• <i>Quality and adequacy of topographic control.</i></li> </ul>	<ul style="list-style-type: none"> <li>• All data was supplied in the World Geodetic System 1984, Zone 52 Northern Hemisphere (UTM).</li> <li>• Collar positions for all holes were laid out by the on-site surveyor using a differential GPS and then checked again once drilling was completed.</li> <li>• Downhole surveys were carried out for all of the diamond drillholes using Reflex Ez-Shot equipment. The measurement was taken every 20m in general.</li> <li>• A topographic survey was conducted in 2014. The survey was carried out using Topcon 5GR satellite receiver. The field data was processed using TOPCONTOOLS software package. This survey is used for the current Mineral Resource Estimate.</li> <li>• The small differences between the GPS readings and the topographical survey data do not influence the interpreted mineralisation widths.</li> </ul>
<b>Data spacing and distribution</b>	<ul style="list-style-type: none"> <li>• <i>Data spacing for reporting of Exploration Results.</i></li> <li>• <i>Whether the data spacing and distribution is sufficient to establish the degree of geological and grade continuity appropriate for the Mineral Resource and</i></li> </ul>	<ul style="list-style-type: none"> <li>• Data spacing is down to 25m x 25m in the central part of deposit. On the flanks the data spacing is more generally between 50m x 50m. This spacing is sufficient to establish geological and mineralisation continuity</li> </ul>

Criteria	JORC Code explanation	Commentary
	<p><i>Ore Reserve estimation procedure(s) and classifications applied.</i></p> <ul style="list-style-type: none"> <li>• <i>Whether sample compositing has been applied.</i></li> </ul>	<p>appropriate for the reporting of Mineral Resources.</p> <ul style="list-style-type: none"> <li>• Mineral Resources are classified as Inferred in accordance with the guidelines of the JORC Code (2012), and through geostatistical analysis considering the spatial distribution of sample data.</li> <li>• Sample compositing was carried out as part of the mineral resource estimation process.</li> <li>• The diamond drill and trench data spacing is deemed by the CP to be sufficient to imply/confirm geological and grade continuity, sufficient for the classification of Inferred resources only.</li> <li>• The average length of the samples is 0.85m therefore the composite length of 1.0m was chosen.</li> </ul>
<p><b>Orientation of data in relation to geological structure</b></p>	<ul style="list-style-type: none"> <li>• <i>Whether the orientation of sampling achieves unbiased sampling of possible structures and the extent to which this is known, considering the deposit type.</i></li> <li>• <i>If the relationship between the drilling orientation and the orientation of key mineralised structures is considered to have introduced a sampling bias, this should be assessed and reported if material.</i></li> </ul>	<ul style="list-style-type: none"> <li>• In general, drilling is carried out so that the intersections of holes with mineralised zones occurs at a high angle which results in limited sample bias.</li> <li>• The general strike of mineralisation is north-west at 330° with shallow dipping at 30-35° to north-east mineralisation hence drilling is generally inclined at –50-60° towards the strike of the zones.</li> <li>• Intercepts are reported as apparent thicknesses except where otherwise stated.</li> </ul>
<p><b>Sample security</b></p>	<ul style="list-style-type: none"> <li>• <i>The measures taken to ensure sample security.</i></li> </ul>	<ul style="list-style-type: none"> <li>• Samples were transported to site sample preparation facilities. After initial crushing and splitting approximately 1kg material was prepared for further assay.</li> <li>• Crushed samples were transported regularly (typically monthly during the drilling campaigns) by commercial carrier to ALS lab in Chita in sealed bags.</li> </ul>

Criteria	JORC Code explanation	Commentary
		<ul style="list-style-type: none"> <li>• After preparation in the field, samples were packed into bags and dispatched to the freight forwarders directly by the Company. All bags were transported by the Company directly to the sample preparation/assay laboratory. The assay laboratory audits the samples on arrival and reports any discrepancies back to the Company.</li> <li>• Sample security was managed by the Company. The CP was not able to inspect the sample dispatches and relies on the Company’s representative to ensure that no discrepancies occurred, and the chain of custody is acceptable.</li> </ul>
<p><b><i>Audits or reviews</i></b></p>	<ul style="list-style-type: none"> <li>• <i>The results of any audits or reviews of sampling techniques and data.</i></li> </ul>	<ul style="list-style-type: none"> <li>• Previous audits were completed by Tetra Tech in 2016/17 who considered that the drill program, logging and sampling procedures are consistent with recognised industry best practices and are considered adequate for this type of deposit.</li> <li>• Tetra Tech checked 10% of the assay certificates against the values contained within the database. No errors were encountered.</li> <li>• With regards blank samples/material, it was concluded that the blank material probably contained minor mineralisation, and it was recommended that the material used for blank samples is re-examined or replaced by material known not to carry any target mineralisation. Commercially-sourced certified blank material would be recommended to eliminate any possibility of minor mineralisation. It was also recommended that the sample preparation apparatus is flushed with a quartz sand wash between samples.</li> </ul>

Criteria	JORC Code explanation	Commentary
		Blank samples were also independently assessed for each campaign, and were found to be well within acceptable limits.

## Section 2 Reporting of Exploration Results

Criteria	JORC Code explanation	Commentary
<b>Mineral tenement and land tenure status</b>	<ul style="list-style-type: none"> <li>Type, reference name/number, location and ownership including agreements or material issues with third parties such as joint ventures, partnerships, overriding royalties, native title interests, historical sites, wilderness or national park and environmental settings.</li> <li>The security of the tenure held at the time of reporting along with any known impediments to obtaining a license to operate in the area.</li> </ul>	<ul style="list-style-type: none"> <li>The NM license is located in the north of Kobayakskiy district in the central of Republic Sakha (Yakutia), Russia, some 400km to the north of Yakutsk city, the Republic capital, and centred on coordinates 65°40'N, 130°07'E.</li> <li>CSJC Prognoz is in possession of an exploration licence with the reference YaKU 12692 BP. The license has an expiry date of 31.12.2023 and covers an area of 570 km<sup>2</sup>.</li> <li>WAI is not aware of any known impediments to obtaining and maintaining a licence to operate the NM Property.</li> <li>The CP has relied on the information provided by SBR that the tenement is in good standing and all fees are paid.</li> </ul>
<b>Exploration done by other parties</b>	<ul style="list-style-type: none"> <li>Acknowledgment and appraisal of exploration by other parties.</li> </ul>	<ul style="list-style-type: none"> <li>The first mention of the presence of silver-base metal mineralisation is related to 1764. Following that up until 1930s individuals were carried out prospecting and small-scale mining in the area.</li> <li>Sporadic exploration was carried out during 1930s and 1940s.</li> <li>Different scale geological mapping and soil-geochemistry</li> </ul>

Criteria	JORC Code explanation	Commentary
		<p>sampling as well as different ground and airborne geophysical survey methods was carried out in 1950s to 1970s. More detailed prospecting works had been carried out on the areas with detected metal anomalies.</p> <ul style="list-style-type: none"> <li>• From 1991 to 2003 JSC Yanageologia completed 151,452m<sup>3</sup> of trenching and 1,303m of drilling focusing on the 15 principal veins systems.</li> <li>• Prospecting/exploration activities include surface trenching, a restricted amount of drilling and underground developments (shallow shafts and adits with crosscuts).</li> <li>• CJSC Prognoz has carried out exploration at NM since 2013 up to present.</li> </ul>
<p><b>Geology</b></p>	<ul style="list-style-type: none"> <li>• <i>Deposit type, geological setting and style of mineralisation.</i></li> </ul>	<ul style="list-style-type: none"> <li>• The NM Property is part of Endybal area which occurs in the north-eastern wing of Kuranakh anticlinorium and being a part of Zapadno-Verkhoyanskiy mega-anticlinorium. The Endybal area is composited by terrigenous sediments of Carboniferous-Triassic age. The sediments intruded by Late Jurassic, Early and Late Cretaceous magmatic rock.</li> <li>• Mineralisation occurs within Mangazeisky syncline which is part of the eastern wing of Endubal anticline. The dip of the rocks of the Endybal anticline in the area of NM averages 20 to 45°.</li> <li>• Mineralisation of NM forms strata-bound veins within sandstone thickness.</li> <li>• Mineralised zones are grouped into two domains – Central and South areas.</li> <li>• Mineralisation is epigenetic polymetallic silver-lead-zinc</li> </ul>



Criteria	JORC Code explanation	Commentary
<b>Drill hole Information</b>	<ul style="list-style-type: none"> <li>• <i>A summary of all information material to the understanding of the exploration results including a tabulation of the following information for all Material drill holes:</i> <ul style="list-style-type: none"> <li>○ <i>easting and northing of the drill hole collar</i></li> <li>○ <i>elevation or RL (Reduced Level – elevation above sea level in metres) of the drill hole collar</i></li> <li>○ <i>dip and azimuth of the hole</i></li> <li>○ <i>down hole length and interception depth</i></li> <li>○ <i>hole length.</i></li> </ul> </li> <li>• <i>If the exclusion of this information is justified on the basis that the information is not Material and this exclusion does not detract from the understanding of the report, the Competent Person should clearly explain why this is the case.</i></li> </ul>	<p>veins hosted by metasediment.</p> <ul style="list-style-type: none"> <li>• Exploration data held in the database and used in the mineral resource estimate can be summarised as follows:           <ul style="list-style-type: none"> <li>– Number of drillholes – 157;</li> <li>– Number of exploration trenches – 50;</li> <li>– East collar ranges – 551,960m to 552,700m.</li> <li>– North collar ranges – 7,289,680m to 7,291,290m</li> <li>– Collar elevation ranges – 1,052.9m to 1,201.5m</li> <li>– Azimuth ranges – 0° to 300°</li> <li>– Dip ranges –37° to +90°</li> <li>– Length of holes/trenches – 2.0m to 122.0m</li> </ul> </li> <li>• Both diamond drillhole and trench information and assay results were used in the Mineral Resource Estimation.</li> </ul>
<b>Data aggregation methods</b>	<ul style="list-style-type: none"> <li>• <i>In reporting Exploration Results, weighting averaging techniques, maximum and/or minimum grade truncations (eg cutting of high grades) and cut-off grades are usually Material and should be stated.</i></li> <li>• <i>Where aggregate intercepts incorporate short lengths of high grade results and longer lengths of low grade results, the procedure used for such aggregation should be stated and some typical examples of such aggregations should be shown in detail.</i></li> <li>• <i>The assumptions used for any reporting of metal equivalent values should be clearly stated.</i></li> </ul>	<ul style="list-style-type: none"> <li>• Top cutting was used during the mineral resource estimation process to reduce the potential for outlier grades to have an overbearing effect on estimated block grades. Top cutting is based on decile analysis and log probability graphs for all zones and applied to Ag, Pb and Zn (detailed in the main body of the text).</li> <li>• No metal equivalent equations were used during the mineral resource estimation procedure or reporting.</li> <li>• Samples were composited to 1m lengths during the mineral resource estimation procedure to ensure a consistent level of support during the estimation process.</li> </ul>

Criteria	JORC Code explanation	Commentary
<b>Relationship between mineralisation widths and intercept lengths</b>	<ul style="list-style-type: none"> <li>• <i>These relationships are particularly important in the reporting of Exploration Results.</i></li> <li>• <i>If the geometry of the mineralisation with respect to the drill hole angle is known, its nature should be reported.</i></li> <li>• <i>If it is not known and only the down hole lengths are reported, there should be a clear statement to this effect (eg 'down hole length, true width not known').</i></li> </ul>	<ul style="list-style-type: none"> <li>• The nature of the main zones of mineralisation at NM is well recognised as being gently dipping narrow strata-bound vein structures.</li> <li>• In general, drilling is carried out so that the intersections of holes with mineralised zones occurs at a high angle to minimise sample bias.</li> <li>• Down hole length reflects drilled meters not the true width of the mineralised structures.</li> </ul>
<b>Diagrams</b>	<ul style="list-style-type: none"> <li>• <i>Appropriate maps and sections (with scales) and tabulations of intercepts should be included for any significant discovery being reported These should include, but not be limited to a plan view of drill hole collar locations and appropriate sectional views.</i></li> </ul>	<ul style="list-style-type: none"> <li>• Appropriate data tabulations, plans and sections showing the nature of the mineralisation, exploration and final mineral resource estimate are included in the main body of the report.</li> </ul>
<b>Balanced reporting</b>	<ul style="list-style-type: none"> <li>• <i>Where comprehensive reporting of all Exploration Results is not practicable, representative reporting of both low and high grades and/or widths should be practiced to avoid misleading reporting of Exploration Results.</i></li> </ul>	<ul style="list-style-type: none"> <li>• Individual exploration results are not being reported. This section is not considered relevant to the overall reporting of the mineral resource estimate.</li> <li>• A total of 157 diamond drillholes and 50 trenches have been completed on the NM and used for the current mineral resource estimate.</li> </ul>
<b>Other substantive exploration data</b>	<ul style="list-style-type: none"> <li>• <i>Other exploration data, if meaningful and material, should be reported including (but not limited to): geological observations; geophysical survey results; geochemical survey results; bulk samples – size and method of treatment; metallurgical test results; bulk density, groundwater, geotechnical and rock characteristics; potential deleterious or contaminating substances.</i></li> </ul>	<ul style="list-style-type: none"> <li>• Metallurgical testwork was used to define recovery factors during pit optimisation used as a basis for limiting potential Mineral Resources based on the expectation of economic extraction.</li> <li>• Geotechnical data of Vertikalny deposit was used during pit optimisation at NM as a basis for limiting potential Mineral Resources based on the expectation of economic extraction.</li> <li>• Density measurement was done for both mineralisation and waste for total 68 samples (40 samples for</li> </ul>

Criteria	JORC Code explanation	Commentary
		<p>mineralisation and 28 for waste).</p> <ul style="list-style-type: none"> <li>No oxide/primary boundary was defined at NM, the entire mineralisation is considered to be primary.</li> </ul>
<b>Further work</b>	<ul style="list-style-type: none"> <li>The nature and scale of planned further work (eg tests for lateral extensions or depth extensions or large-scale step-out drilling).</li> <li>Diagrams clearly highlighting the areas of possible extensions, including the main geological interpretations and future drilling areas, provided this information is not commercially sensitive.</li> </ul>	<ul style="list-style-type: none"> <li>No planned exploration drilling is currently known about.</li> <li>Mineralisation of Central domain is closed along strike at north-west and south-east.</li> <li>Mineralisation of South domain not closed to the south-east.</li> <li>Mineralisation is not closed at depth.</li> </ul>

### Section 3 Estimation and Reporting of Mineral Resources

Criteria	JORC Code explanation	Commentary
<b>Database integrity</b>	<ul style="list-style-type: none"> <li>Measures taken to ensure that data has not been corrupted by, for example, transcription or keying errors, between its initial collection and its use for Mineral Resource estimation purposes.</li> <li>Data validation procedures used.</li> </ul>	<ul style="list-style-type: none"> <li>The project database is held in MS Access and Excel format files. Data held includes collar location, downhole surveys, assay information, lithological logging and oxidation logging. Also held in Microsoft Excel spreadsheets is information on duplicate samples certified reference materials and blanks.</li> <li>Access to the NM drilling/trenching database used for resource estimation is restricted to geological and selected technical staff.</li> <li>WAI completed a number of checks on the raw data supplied by CJSC Prognoz and is satisfied that the data does not contain significant errors, nor has it been corrupted.</li> <li>Validation of the database was carried out during import of the data in to Datamine Studio 3 for production of the</li> </ul>

Criteria	JORC Code explanation	Commentary
<b>Site visits</b>	<ul style="list-style-type: none"> <li>• <i>Comment on any site visits undertaken by the Competent Person and the outcome of those visits.</i></li> <li>• <i>If no site visits have been undertaken indicate why this is the case.</i></li> </ul>	<p>mineral resource estimate, no major issues were found with duplicate or overlapping samples.</p> <ul style="list-style-type: none"> <li>• A site visit was undertaken by Nikolai Shatkov (MAIG) on 30<sup>th</sup> October 2021.</li> <li>• The site visits included inspection of the current open pit operations, processing plant, inspection of current drilling, a visit to the core shed (core cutting and sample preparation), logging facilities, on-site laboratory, and discussions with senior and key geological staff to verify the data collection and management.</li> </ul>
<b>Geological interpretation</b>	<ul style="list-style-type: none"> <li>• <i>Confidence in (or conversely, the uncertainty of) the geological interpretation of the mineral deposit.</i></li> <li>• <i>Nature of the data used and of any assumptions made.</i></li> <li>• <i>The effect, if any, of alternative interpretations on Mineral Resource estimation.</i></li> <li>• <i>The use of geology in guiding and controlling Mineral Resource estimation.</i></li> <li>• <i>The factors affecting continuity both of grade and geology.</i></li> </ul>	<ul style="list-style-type: none"> <li>• Grade estimation for NM uses diamond and trench sampling only.</li> <li>• The confidence in the geological interpretation is deemed good. Exploration drilling has been carried out on a grid down to 25m x 25m, with wider spacing on the flanks - between 50m and 50m, and geological logging is comprehensive.</li> <li>• There is no data for definition of oxide/primary boundary therefor the entire mineralisation is considered as primary.</li> <li>• Geological logging has been carried out from drill core samples and in trenches.</li> <li>• Geological logging was used to define mineralised domains within the overall resource model.</li> <li>• The wireframes used to constrain the block model and grade interpolation were constructed based on Prognoz's understanding of the geology and mineralisation of the NM deposit.</li> <li>• The resource model reflects the interpretation north-</li> </ul>

Criteria	JORC Code explanation	Commentary
<p><b>Dimensions</b></p>	<ul style="list-style-type: none"> <li><i>The extent and variability of the Mineral Resource expressed as length (along strike or otherwise), plan width, and depth below surface to the upper and lower limits of the Mineral Resource.</i></li> </ul>	<p>west orientated vein system (zones) reflecting areas of elevated mineralisation.</p> <ul style="list-style-type: none"> <li>The mineralisation is split on two domains which have north-west strike. The overall mineralisation dimension is 1,095m in north-west direction and up to 10m across strike. The depth of mineralisation is 130m from the surface.</li> <li>The current mineral resource is constrained by two optimised open pit with a total strike length of 1,1km, a maximum width of 250m at the crest, and a maximum depth of pit 120m (measured from south-west highwall to pit bottom).</li> <li>The unconstrained block model has a maximum depth of mineralisation up to 130m from the surface.</li> </ul>
<p><b>Estimation and modelling techniques</b></p>	<ul style="list-style-type: none"> <li><i>The nature and appropriateness of the estimation technique(s) applied and key assumptions, including treatment of extreme grade values, domaining, interpolation parameters and maximum distance of extrapolation from data points. If a computer assisted estimation method was chosen include a description of computer software and parameters used.</i></li> <li><i>The availability of check estimates, previous estimates and/or mine production records and whether the Mineral Resource estimate takes appropriate account of such data.</i></li> <li><i>The assumptions made regarding recovery of by-products.</i></li> <li><i>Estimation of deleterious elements or other non-grade variables of economic significance (eg sulphur for acid</i></li> </ul>	<ul style="list-style-type: none"> <li>Two domains were created to represent each of the mineralised structures (zones).</li> <li>DTM surfaces were created to represent the pre-mining topographical surface.</li> <li>A block model was created using the geological and mineralised zone wireframes as boundaries. A parent block size of 10m (X) x 10m (Y) x 10m (Z) was used in the block model with key fields established for geological and mineralised domains.</li> <li>Grade capping: Grade capping was carried out to stop local overestimation of grade from high-grade outlier samples. Grade capping was used for all variables on a zone-by-zone basis where outlier grades were identified using a combination of decile analysis and a review of log-probability plots.</li> </ul>

Criteria	JORC Code explanation	Commentary
	<p><i>mine drainage characterisation).</i></p> <ul style="list-style-type: none"> <li><i>• In the case of block model interpolation, the block size in relation to the average sample spacing and the search employed.</i></li> <li><i>• Any assumptions behind modelling of selective mining units.</i></li> <li><i>• Any assumptions about correlation between variables.</i></li> <li><i>• Description of how the geological interpretation was used to control the resource estimates.</i></li> <li><i>• Discussion of basis for using or not using grade cutting or capping.</i></li> <li><i>• The process of validation, the checking process used, the comparison of model data to drill hole data, and use of reconciliation data if available.</i></li> </ul>	<ul style="list-style-type: none"> <li>• Composites: A 1m composite length was chosen to ensure consistent sample support during estimation. Composites were limited to the boundaries of mineralised domains.</li> <li>• Variography: A variographic study by domain identified reasonably robust variogram models for Ag across main mineralised zone.</li> <li>• Estimation: Estimation was carried out using Ordinary Kriging as the primary method. An Inverse distance (squared) estimate was carried out for validation purposes. Only composite samples within an individual zone were used for estimation of that zone. Estimation parameters were based on models of grade continuity produced during geostatistical analysis. Dynamic anisotropy was used to change orientations of search ellipses based on local variations of dip and strike. Minimum and maximum sample criteria, an octant search restriction and restrictions of number of composite samples from a single drillhole were employed during grade estimation to assist with declustering and to reduce local grade bias. A multiple pass estimation as carried out with expanding search ellipses and less restrictive estimation parameters for estimating blocks in more poorly sampled areas.</li> <li>• Estimation was carried out into parent cells only to reduce risk of conditional bias. Estimation was carried out using a discretisation of five points in each dimension.</li> <li>• The block model was verified first by comparing drillhole composite sample values with estimated block</li> </ul>

Criteria	JORC Code explanation	Commentary
		<p>values on a sectional and plan basis. Grade comparison was also carried out statistically by zone to ensure the global grade estimate was unbiased. Grade profile (swath) plots were also constructed to compare modelled grades and input composite grades in slices or varying width. During this process a comparison was made between declustered and clustered data to identify any possible local bias introduced by irregular grade spacing.</p> <ul style="list-style-type: none"> <li>• No estimation of deleterious components was carried out.</li> <li>• The estimated block model was validated by visual inspection of block grades in comparison with drillhole data, and comparison of the block model statistics.</li> </ul>
<b>Moisture</b>	<ul style="list-style-type: none"> <li>• <i>Whether the tonnages are estimated on a dry basis or with natural moisture, and the method of determination of the moisture content.</i></li> </ul>	<ul style="list-style-type: none"> <li>• All tonnages are reported as dry tonnages.</li> <li>• Moisture content has been measured using weighing waxed samples and dried ones.</li> </ul>
<b>Cut-off parameters</b>	<ul style="list-style-type: none"> <li>• <i>The basis of the adopted cut-off grade(s) or quality parameters applied.</i></li> </ul>	<ul style="list-style-type: none"> <li>• Mineralised zones are defined at a natural cut-off grade of 50g/t Ag.</li> <li>• The mineral resource estimate is restricted to material falling within an NPV Scheduler optimised pit shell as described below in “Mining factors or assumptions”, and above a cut-off grade representing breakeven cut-off grade derived from open pit optimisation parameters for each zone.</li> </ul>
<b>Mining factors or assumptions</b>	<ul style="list-style-type: none"> <li>• <i>Assumptions made regarding possible mining methods, minimum mining dimensions and internal (or, if applicable, external) mining dilution. It is always necessary as part of the process of determining</i></li> </ul>	<ul style="list-style-type: none"> <li>• The deposit is deemed to be appropriate to being mined by standard open pit mining operation.</li> <li>• Reporting of mineral resources suitable for open pit extraction were limited by the creation of an optimised</li> </ul>

Criteria	JORC Code explanation	Commentary
	<p><i>reasonable prospects for eventual economic extraction to consider potential mining methods, but the assumptions made regarding mining methods and parameters when estimating Mineral Resources may not always be rigorous. Where this is the case, this should be reported with an explanation of the basis of the mining assumptions made.</i></p>	<p>open pit shell in NPV Scheduler. The optimisation was carried out using Net Smelter Return data. The approach to NSR estimation is presented in the main text body. The pit shell was created with the following major parameters:</p> <ul style="list-style-type: none"> <li>– NSR (primary) – US\$/t – 139.06;</li> <li>– Mining cost (mineralisation/waste) of US\$2.53/t;</li> <li>– Oxide processing cost of US\$72.91/t;</li> <li>– Primary processing cost US\$46.97/t</li> <li>– Processing recovery – 95%;</li> <li>– G&amp;A cost of US\$60.0/t</li> <li>– Slope angle - 56° at hanging wall, 48° at foot wall;</li> <li>– Mining dilution of 30% and mining losses of 0%.</li> </ul>
<p><b>Metallurgical factors or assumptions</b></p>	<ul style="list-style-type: none"> <li>• <i>The basis for assumptions or predictions regarding metallurgical amenability. It is always necessary as part of the process of determining reasonable prospects for eventual economic extraction to consider potential metallurgical methods, but the assumptions regarding metallurgical treatment processes and parameters made when reporting Mineral Resources may not always be rigorous. Where this is the case, this should be reported with an explanation of the basis of the metallurgical assumptions made.</i></li> </ul>	<ul style="list-style-type: none"> <li>• Metallurgical recovery was utilised during the construction of an optimised pit shell used for limiting mineral resources based on an expectation of eventual economic extraction.</li> </ul>
<p><b>Environmental factors or assumptions</b></p>	<ul style="list-style-type: none"> <li>• <i>Assumptions made regarding possible waste and process residue disposal options. It is always necessary as part of the process of determining reasonable prospects for eventual economic extraction to consider the potential environmental impacts of the mining and processing operation. While at this stage the</i></li> </ul>	<ul style="list-style-type: none"> <li>• WAI is unaware of any environmental factors which would preclude the reporting of Mineral Resources.</li> </ul>



Criteria	JORC Code explanation	Commentary
	<p><i>determination of potential environmental impacts, particularly for a greenfields project, may not always be well advanced, the status of early consideration of these potential environmental impacts should be reported. Where these aspects have not been considered this should be reported with an explanation of the environmental assumptions made.</i></p>	
<b>Bulk density</b>	<ul style="list-style-type: none"> <li>• <i>Whether assumed or determined. If assumed, the basis for the assumptions. If determined, the method used, whether wet or dry, the frequency of the measurements, the nature, size and representativeness of the samples.</i></li> <li>• <i>The bulk density for bulk material must have been measured by methods that adequately account for void spaces (vugs, porosity, etc), moisture and differences between rock and alteration zones within the deposit.</i></li> <li>• <i>Discuss assumptions for bulk density estimates used in the evaluation process of the different materials.</i></li> </ul>	<ul style="list-style-type: none"> <li>• Density measurements have been taken for primary material and waste with respect to natural moisture.</li> <li>• A total of 68 density measurements have been taken for primary and waste material.</li> <li>• Measurements were made using the Archimedes water immersion method, the results were recorded and imported into Excel spreadsheet.</li> <li>• Density was assigned to the block model during the Mineral Resource estimation by applying 3.56t/m<sup>3</sup> for primary material and 2.75 for waste.</li> <li>• Moisture content was measured for oxide and primary material.</li> <li>• The tonnage is reported on a dry basis.</li> </ul>
<b>Classification</b>	<ul style="list-style-type: none"> <li>• <i>The basis for the classification of the Mineral Resources into varying confidence categories.</i></li> <li>• <i>Whether appropriate account has been taken of all relevant factors (ie relative confidence in tonnage/grade estimations, reliability of input data, confidence in continuity of geology and metal values, quality, quantity and distribution of the data).</i></li> <li>• <i>Whether the result appropriately reflects the Competent Person's view of the deposit.</i></li> </ul>	<ul style="list-style-type: none"> <li>• Mineral Resource classification was carried out in accordance with the guidelines of the JORC Code (2012).</li> <li>• The NM Silver Project is considered to be at an advance stage of development being explored on the tight drilling pattern of 25m x 25m. However, there is no robust definition of oxide/primary mineralisation based on the appropriate assay data and/or metallurgical testwork and as such the resources are reported of Inferred category only.</li> <li>• The mineral resource estimate classification reflects the Competent Person's view of the NM Project.</li> </ul>

Criteria	JORC Code explanation	Commentary
		<ul style="list-style-type: none"> <li>Mineral Resources for open pit mining were limited using an optimised pit shell using parameters as laid out in the main section of the report and as described in “Mining factors and assumptions” above.</li> <li>The mineral resource estimate has been limited to the surveyed surface as detailed in the main report.</li> </ul>
<b>Audits or reviews</b>	<ul style="list-style-type: none"> <li><i>The results of any audits or reviews of Mineral Resource estimates.</i></li> </ul>	<ul style="list-style-type: none"> <li>WAI is not aware of any audits or reviews of this Mineral Resource Estimate other than internal peer review.</li> </ul>
<b>Discussion of relative accuracy/ confidence</b>	<ul style="list-style-type: none"> <li><i>Where appropriate a statement of the relative accuracy and confidence level in the Mineral Resource estimate using an approach or procedure deemed appropriate by the Competent Person. For example, the application of statistical or geostatistical procedures to quantify the relative accuracy of the resource within stated confidence limits, or, if such an approach is not deemed appropriate, a qualitative discussion of the factors that could affect the relative accuracy and confidence of the estimate.</i></li> <li><i>The statement should specify whether it relates to global or local estimates, and, if local, state the relevant tonnages, which should be relevant to technical and economic evaluation. Documentation should include assumptions made and the procedures used.</i></li> <li><i>These statements of relative accuracy and confidence of the estimate should be compared with production data, where available.</i></li> </ul>	<ul style="list-style-type: none"> <li>The relative accuracy and confidence in the mineral resource estimate is reflected in the reporting of the mineral resource as set out in the JORC Code (2012)</li> <li>The statement relates to global estimates of tonnes and grade.</li> <li>The classification applied to the mineral resource estimate is based upon; confidence of continuity of mineralisation, quality of data (QA/QC) and validation of the block model.</li> </ul>

## **APPENDIX 4: FINANCIAL MODEL**

**Wardell Armstrong International  
Financial Model**



**SBR**

Russia

**May-20**

**Assumptions**

46.51 NPV @ 8.64%

Time Parameters	Source of data	Units	Average	Total	Y1 Q4	Q1/2020	Q2/2020	Q3/2020	Q4/2020	Y2	Q1/2021	Q2/2021	Q3/2021	Q4/2021	Y3	Q1/2022	Q2/2022	Q3/2022	Q4/2022	Y4	Y5	Y6	Y7	Y8
Number of period					01-Nov-19	01-Jan-20	01-Apr-20	01-Jul-20	01-Oct-20	01-Jan-21	01-Jan-21	01-Apr-21	01-Jul-21	01-Oct-21	01-Jan-22	01-Jan-22	01-Apr-22	01-Jul-22	01-Oct-22	01-Jan-23	01-Jan-23	01-Jan-24	01-Jan-25	01-Jan-26
Beginning of period					31-Dec-19	31-Mar-20	30-Jun-20	30-Sep-20	31-Dec-20	31-Dec-20	31-Mar-21	30-Jun-21	30-Sep-21	31-Dec-21	31-Dec-21	31-Mar-22	30-Jun-22	30-Sep-22	31-Dec-22	31-Dec-22	31-Dec-23	31-Dec-24	31-Dec-25	31-Dec-26
Days in year					41	91	92	92	92	366	90	91	91	92	365	90	91	92	92	365	365	366	365	365

Metal Prices			
Ag	SP ANGLE I27 (08.18)	17.76	Real 2019
Pb	SP ANGLE I27 (08.18)	5.6	
Zn	SP ANGLE I27 (08.18)	2.922 <td></td>	
			Nominal
			17.76
			5.6
			2.922

**Macroeconomic Assumptions**

RUB/USD	SSR forecast	65
Annual Inflation for Russia (RUB)	SSR forecast	0.00%
Cumulative -cove (RUB)		1.18%
Annual Inflation for OECD (RUB)		1.18%
Cumulative -Cove (RUB)		1.18%
Long Term Inflation USD	WAI Assumption	2.00%
Cumulative Inflation USD		0.00%
Taxes		
Corporate Income Tax		20%
VAT (not in use)		20%
Mineral Extraction Tax (Mining Royalty)		8.0%
Base Metals		6.5%

Depreciation Groups			
Buildings	%	10.00%	
Machinery and equipment	%	25.00%	
Vehicles	%	40.00%	
Furniture, facilities	%	15.00%	
Depreciation Rate (Weighted average)	%	15.00%	

Working Capital			
No Days in Year	days	165.21	
No Months in Year	months	12	
Accounts payable	days	45	
Accounts receivable	days	30	
Inventory	days	30	

Currency components			
USD	RUB	Real 2019	Nominal
100%	0%		
100%	0%		
100%	0%		
100%	0%		

Payment to Reclamation Fund			
Payment to Reclamation	ARO 2017-2028 v3.xlsx	Rub/000	312,168

**Leasing Terms**

Source: SSR data, based on the actual contracts

Leasing of OP mining equipment  
Period between Jan 2020 to Feb 2023

N Yrs	N Months	Leasing Payments	Price Incl VAT	Interest on Leasing	Currency
2.00	24	Drill Rig Flexi Rock D60	56,776,534	8,023,273	RUB
3.00	36	Excavator CAT 374E1	730,000	105,876	USD
3.00	36	Dump Truck CAT740GC	586,400	85,049	USD
3.00	36	Dump Truck CAT740GC	586,400	85,049	USD
3.00	36	Dump Truck CAT740GC	586,400	85,049	USD
1.25	15	Dump Truck SCANIA G440	12,340,000	1,670,840	RUB
1.25	15	Dump Truck SCANIA G440	12,340,000	1,670,840	RUB
1.25	15	Dump Truck SCANIA G440	12,340,000	1,670,840	RUB
0.25	3	Dump Truck SCANIA G440	12,340,000	334,168	RUB
0.25	3	Dump Truck SCANIA G440	12,340,000	334,168	RUB
0.25	3	Dump Truck SCANIA G440	12,340,000	334,168	RUB
Total RUB					197,823,618
Total USD					2,901,514
Total in USD					4,699,680

- Source of data:
- Пример рассмотреть следующую информацию по стоимости корпоративного оборудования, которое будет находиться в лизинге с января 2020 года по февраль 2023 года:
- Бульдозер станция FlexiRock D60 – полная стоимость 56 776 534 руб (вкл НДС), сумма процентов по лизинговым платежам 8 023 273 руб. (вкл НДС), 24 месяца;
  - Экскаватор CAT 374E1 – полная стоимость 730 000 долларов США (вкл НДС), сумма процентов по лизинговым платежам 105 876 долларов США (вкл НДС), 36 месяцев;
  - Самосвалы CAT740GC – полная стоимость 586 400 долларов США (вкл НДС), сумма процентов по лизинговым платежам 85 049 долларов США (вкл НДС), 36 месяцев;
  - Самосвалы CAT740GC – полная стоимость 586 400 долларов США (вкл НДС), сумма процентов по лизинговым платежам 85 049 долларов США (вкл НДС), 36 месяцев;
  - Самосвалы SCANIA G440 – полная стоимость 12 340 000 руб (вкл НДС), сумма процентов по лизинговым платежам 1 670 840 руб. (вкл НДС), 15 месяцев;
  - Самосвалы SCANIA G440 – полная стоимость 12 340 000 руб (вкл НДС), сумма процентов по лизинговым платежам 1 670 840 руб. (вкл НДС), 15 месяцев;
  - Самосвалы SCANIA G440 – полная стоимость 12 340 000 руб (вкл НДС), сумма процентов по лизинговым платежам 1 670 840 руб. (вкл НДС), 15 месяцев;
  - Самосвалы SCANIA G440 – полная стоимость 12 340 000 руб (вкл НДС), сумма процентов по лизинговым платежам 334 168 руб. (вкл НДС), 3 месяцев;
  - Самосвалы SCANIA G440 – полная стоимость 12 340 000 руб (вкл НДС), сумма процентов по лизинговым платежам 334 168 руб. (вкл НДС), 3 месяцев;
  - Самосвалы SCANIA G440 – полная стоимость 12 340 000 руб (вкл НДС), сумма процентов по лизинговым платежам 334 168 руб. (вкл НДС), 3 месяцев;

Depreciation of leased equipment – expense.  
Principal payments – cash  
Lease interest payments – financial expenses

Supporting data			
Units Converter	1000		Name
	1000000		thous
	11.1001		mil
1 ea =			ea to e
1 ka =	32.15074326		ka to ea

Tonnage/UnitList			
Units Converter	Convert to (t)	Multiplied by	
Mt	t	1.000	
Mt	t	1,000,000	
Grade/UnitList	Convert to (t)	Grade/CoefficientList	
Units Converter	t	Multiplied by	
%	t	0.01	
1/t	t	0.00001	

Product/UnitList			
From (t to)	Multiplied by	Price/UnitList	Multiplied by
kg	1,000,000	USD/t	1,000,000
kg	1,000	USD/kg	1,000
kg	32.15074326	USD/ka	32.15074326
Mt	0.001	USD/Mt	0.001
lb	2.205	USD/lb	2.205
Oz	32.151	USD/oz	32.151
t	1	USD/t	1

List			
No	1		
Yes	2		
to be updated			

Production Inputs		46.51 NPV	@ 8.64%																								
Currency component	YEAR	Units	Assumption	Total	Y1 Q4	Q 1/2020	Q 2/2020	Q 3/2020	Q 4/2020	Y2	Q 1/2021	Q 2/2021	Q 3/2021	Q 4/2021	Y3	Q 1/2022	Q 2/2022	Q 3/2022	Q 4/2022	Y4	Y5	Y6	Y7	Y8			
USD	RUB				01-Nov-19	01-Jan-20	01-Apr-20	01-Jul-20	01-Oct-20	01-Jan-20	01-Jan-21	01-Apr-21	01-Jul-21	01-Oct-21	01-Jan-21	01-Jan-22	01-Apr-22	01-Jul-22	01-Oct-22	01-Jan-22	01-Jan-23	01-Jan-24	01-Jan-25	01-Jan-26			
					31-Dec-19	31-Mar-20	30-Jun-20	30-Sep-20	31-Dec-20	31-Dec-20	31-Mar-21	30-Jun-21	30-Sep-21	31-Dec-21	31-Dec-21	31-Mar-22	30-Jun-22	30-Sep-22	31-Dec-22	31-Dec-22	31-Dec-23	31-Dec-24	31-Dec-25	31-Dec-26			

1. PRODUCTION SCHEDULE

				1,662,104	23,640	30,717	48,836	51,169	44,893	175,615	36,024	61,350	91,972	52,146	241,492	52,148	51,388	72,095	85,850	261,482	269,704	254,121	273,121	162,929	
<b>1.1 Mining Physicals: total mined</b>																									
<b>Vertikally Open Pit</b>																									
	Mineralised Material	t		402,843	23,640	30,717	48,836	51,169	44,893	175,615	36,024	61,350	91,972	52,146	241,492	52,148	51,388	72,095	85,850	261,482	269,704	254,121	273,121	162,929	
	Waste Material	t		10,995,762	382,943	703,343	1,610,736	1,603,752	1,611,106	5,528,938	1,988,975	1,986,149	846,328	262,430	5,083,882	0	0	0	0	0	0	0	0	0	0
<b>Mangazeyksky North Open Pit</b>																									
	Mineralised Material	t		418,996	-	0	0	0	0	0	0	0	0	0	0	0	0	0	0	0	0	0	0	0	
	Waste Material	t		8,543,326	-	0	0	0	0	0	0	0	0	0	0	0	0	0	0	0	0	0	0	0	
<b>Vertikally Underground Mining</b>																									
	Mineralised Material	t		840,265	-	0	0	0	0	0	0	0	0	0	0	0	0	0	0	0	0	0	0	0	
<b>Vertikally Underground Development</b>																									
	Decline	m		7,411	-	0	0	0	0	0	0	0	0	0	0	0	0	0	0	0	0	0	0	0	
	Level Access	m		9,982	-	0	0	0	0	0	0	0	0	0	0	0	0	0	0	0	0	0	0	0	
	Vent Connection	m		1,061	-	0	0	0	0	0	0	0	0	0	0	0	0	0	0	0	0	0	0	0	
<b>1.2 Ore Sorter Feed</b>																									
<b>Total Ore feed to Sorter</b>				1,707,264	20,039	29,894	45,500	45,500	46,251	167,145	45,500	45,500	45,500	45,500	68,181	204,681	68,180	68,180	68,180	68,180	272,720	272,720	272,720	272,720	224,519
<b>Leach Plant (Current)</b>				344,525	20,039	29,894	45,500	45,500	46,251	167,145	45,500	45,500	45,500	45,500	20,841	157,341	-	-	-	-	0	0	0	0	0
<b>Oxide Feed</b>				302,594	20,039	29,894	45,500	45,500	37,418	158,311	12,402	45,500	45,500	45,500	20,841	124,243	0	0	0	0	0	0	0	0	0
	Ag (Oxide)	g/t		588	588	581	783	412	177	495	393	803	766	716	734	0	0	0	0	0	0	0	0	0	
	Ag (Oxide)	oz'000		5,831	379	558	1,146	603	213	2,520	1,121	1,175	803	480	2,933	157	0	0	0	0	0	0	0	0	
<b>Sulphide Feed</b>				41,931	-	0	0	0	8,833	8,833	33,098	0	0	0	0	33,098	0	0	0	0	0	0	0	0	0
	Ag (Sulphide)	g/t		-	-	0	0	0	762	762	671	671	671	671	671	0	0	0	0	0	0	0	0	0	
	Ag (Sulphide)	oz'000		931	0	0	0	0	216	216	714	714	714	714	714	0	0	0	0	0	0	0	0	0	
<b>Flotation Plant</b>				1,362,739	0.0	0	0	0	0	0	0	0	0	0	47,340	47,340	68,180	68,180	68,180	68,180	272,720	272,720	272,720	272,720	224,519
	Feed	t		0.0	0.0	0	0	0	0	0	0	0	0	641	641	564	538	502	475	520	451	394	428	460	
	Ag	g/t		25,544	0	0	0	0	0	0	0	0	0	975	975	1,236	1,180	1,106	1,042	4,557	3,952	3,457	3,749	3,322	
	Ag	oz'000		-	-	-	-	-	-	-	-	-	-	2	2	3	3	3	5	5	4	5	2	2	
	Pb	%		-	-	-	-	-	-	-	-	-	-	1	1	1	1	1	1	1	2	2	1	1	
	Zn	%		-	-	-	-	-	-	-	-	-	-	1	1	1	1	1	1	1	2	2	1	1	
<b>Total Mined Metals (Mining Royalty Basis)</b>				26,774	379	558	1,146	603	429	2,736	871	1,175	1,121	1,155	4,622	1,736	1,180	1,100	1,042	4,557	3,952	3,457	3,749	3,322	
	Ag	oz'000	Recovered	22,081	30,929	16,908																			
82.47%	Pb	t		44,948	0	0	0	0	0	0	0	0	0	1,095	2,141	2,934	3,362	3,297	11,734	14,494	6,469	4,340	6,815		
68.81%	Zn	t		17,969	0	0	0	0	0	0	0	0	0	594	594	581	420	341	504	1,846	4,100	5,154	4,012	2,263	
94.09%																									

				1,143,771	20,039	29,894	30,030	30,030	30,526	120,479	30,030	30,030	30,030	45,000	135,090	44,999	44,999	44,999	44,999	179,995	179,995	179,995	179,995	148,182	
<b>1.3 Process Plant Feed</b>																									
<b>Leach Plant (Current)</b>				244,364	20,039	29,894	30,030	30,030	30,526	120,479	30,030	30,030	30,030	13,755	103,845	0	0	0	0	0	0	0	0	0	0
<b>Oxide Feed</b>				216,689	20,039	29,894	30,030	30,030	24,696	114,650	8,185	30,030	30,030	13,755	82,001	0	0	0	0	0	0	0	0	0	0
	Ag (Oxide)	g/t		588	588	581	1,175	618	266	678	589	1,074	1,101	0	0	0	0	0	0	0	0	0	0	0	
	Ag (Oxide)	oz'000		5,782	379	558	1,138	629	211	2,500	1,121	1,175	803	480	2,933	157	0	0	0	0	0	0	0	0	
<b>Sulphide Feed</b>				27,675	-	0	0	0	5,830	5,830	21,845	0	0	0	21,845	0	0	0	0	0	0	0	0	0	0
	Ag (Sulphide)	g/t		-	-	0	0	0	1,143	1,143	1,007	1,007	1,007	1,007	1,007	0	0	0	0	0	0	0	0	0	
	Ag (Sulphide)	oz'000		921	0	0	0	0	214	214	707	707	707	707	707	0	0	0	0	0	0	0	0	0	
<b>Flotation Plant (Available in mid 2021)</b>				899,408	-	0	0	0	0	0	0	0	0	31,244	31,244	44,999	44,999	44,999	44,999	44,999	179,995	179,995	179,995	179,995	148,182
	Sulphide	t		-	-	0	0	0	0	0	0	0	961	961	846	807	752	713	780	676	591	641	690		
	Ag	g/t		-	-	0	0	0	0	0	0	0	3	3	5	7	7	8	8	5	4	4	3		
	Pb	%		-	-	0	0	0	0	0	0	0	1	1	1	1	1	1	1	1	2	2	1		
	Zn	%		-	-	0	0	0	0	0	0	0	1	1	1	1	1	1	1	1	2	2	1		

2. REVENUE

Metal Prices		US\$/Oz	US\$/t	US\$/t	US\$/t	US\$/t	US\$/t	US\$/t	US\$/t	US\$/t	US\$/t	US\$/t	US\$/t	US\$/t	US\$/t	US\$/t	US\$/t	US\$/t	US\$/t	US\$/t	US\$/t	US\$/t	US\$/t	US\$/t
Ag	US\$/Oz	17.76	17.85	17.94	18.03	18.12	18.12	18.21	18.30	18.39	18.48	18.48	18.57	18.66	18.75	18.85	18.85	19.22	19.61	20.00	20.40			
Pb	US\$/t	2,069	2,079	2,090	2,100	2,110	2,110	2,121	2,131	2,142	2,153	2,153	2,163	2,174	2,185	2,196	2,196	2,240	2,284	2,330	2,377			
Zn	US\$/t	2,252	2,263	2,274	2,286	2,297	2,297	2,308	2,320	2,331	2,343	2,343	2,355	2,366	2,378	2,390	2,390	2,438	2,486	2,536	2,587			
g/Oz		31.1035																						

2.1 Leach Plant (Current Plant)				85.00	85	85	85	85	85	85	85	85	85	85	85	85	85	85	85	85	85	85	85	85
<b>Mill Recovery (Silver Only)</b>																								
	Oxides	%		28.90	29	29	29	29	29	29	29	29	29	29	29	29	29	29	29	29	29	29	29	29
	Sulphides	%																						
	Recovered Silver	g		161,154,798	10,020,283	14,755,517	29,986,205	15,781,909	7,499,856	68,023,488	10,454,097	30,756,723	29,342,118	12,556,090	83,111,028	0	0	0	0	0	0	0	0	0
	Recovered Silver	oz'000		32																				

Ag Value in Zn Concentrate (Less: Refining Co		US\$ nominal	7,752,231	0	0	0	0	0	0	0	0	0	0	0	358,332	358,332	456,498	437,824	410,191	390,533	1,695,047	1,511,098	1,348,435	1,491,363	1,347,957		
Zinc Concentrate NSR		US\$ nominal	13,590,506	0	0	0	0	0	0	0	0	0	0	0	515,118	515,118	610,566	549,663	501,459	526,241	2,187,929	2,636,270	2,718,403	2,835,776	2,697,010		
<b>ii) Lead Concentrate</b>																											
Mill Recovery		Pb %	66	66	66	66	66	66	66	66	66	66	66	66	66	66	66	66	66	66	66	66	66	66	66	66	66
Contained Metal		Pb t	30,929	0	0	0	0	0	0	0	0	0	0	0	715	1,397	1,914	1,914	2,194	2,151	7,655	9,456	5,760	4,346	2,997		
		Ag g	400,537,043	0	0	0	0	0	0	0	0	0	0	0	19,514,327	24,737,591	23,808,488	22,009,193	20,850,936	20,850,936	91,206,208	79,097,109	69,198,645	75,032,746	66,488,008		
		Ag oz'000	12,878	0	0	0	0	0	0	0	0	0	0	627	795	759	759	793	708	2,151	2,932	2,543	2,225	2,412	2,138		
Concentrate		Pb %	17	17	17	17	17	17	17	17	17	17	17	17	17	17	17	17	17	17	17	17	17	17	17		
		Ag g/t	-	-	-	-	-	-	-	-	-	-	-	-	4,669	4,669	3,028	2,109	1,716	1,658	2,037	1,430	2,054	2,962	3,794		
		Mass t	180,870	0	0	0	0	0	0	0	0	0	0	0	4,180	4,180	8,169	11,192	12,828	12,828	44,767	55,300	33,682	25,416	17,526		
Payment Terms		Deductions for Lead %	0	0	0	0	0	0	0	0	0	0	0	0	0	0	0	0	0	0	0	0	0	0	0		
		Pb Payability %	84	84	84	84	84	84	84	84	84	84	84	84	84	84	84	84	84	84	84	84	84	84	84		
		Deductions for Ag g	0	0	0	0	0	0	0	0	0	0	0	0	0	0	0	0	0	0	0	0	0	0	0		
		Ag Payability %	84	84	84	84	84	84	84	84	84	84	84	84	84	84	84	84	84	84	84	84	84	84	84		
Gross Revenue		Gross Value of Lead Concentrate US\$ nominal	269,321,534	0	-	-	-	-	-	-	-	-	-	-	11,030,259	11,030,259	14,944,020	15,393,250	15,173,134	14,579,877	60,090,281	58,854,745	47,696,486	49,035,156	42,614,606		
		Pb in Lead Concentrate Value US\$ nominal	58,648,706	0	-	-	-	-	-	-	-	-	-	-	1,292,316	1,292,316	2,538,326	3,495,034	4,025,881	3,966,849	14,026,089	17,789,487	11,051,741	8,506,227	5,982,846		
		Ag in Lead Concentrate Value US\$ nominal	210,672,828	0	-	-	-	-	-	-	-	-	-	-	9,737,942	9,737,942	12,405,694	11,898,217	11,147,253	10,613,029	46,064,192	41,065,258	36,644,746	40,528,930	36,631,761		
		Transport Cost US\$ nominal	8%	58,589,668	0	-	-	-	-	-	-	-	-	-	1,291,015	1,291,015	2,535,771	3,491,515	4,021,829	3,962,856	14,011,970	17,771,579	11,040,616	8,497,664	5,976,823		
		Treatment Cost US\$ nominal	-	-	-	-	-	-	-	-	-	-	-	-	0	0	0	0	0	0	0	0	0	0	0		
		Refining Cost Pb US\$ nominal	-	-	-	-	-	-	-	-	-	-	-	-	0	0	0	0	0	0	0	0	0	0	0		
		Refining Cost Ag US\$ nominal	5,648,671	0	-	-	-	-	-	-	-	-	-	-	261,099	261,099	332,628	319,021	298,886	284,562	1,235,097	1,101,063	982,538	1,086,683	982,190		
		Total Costs US\$ nominal	64,238,339	0	-	-	-	-	-	-	-	-	-	-	1,552,114	1,552,114	2,868,399	3,810,537	4,320,715	4,247,418	15,247,068	18,876,643	12,023,154	9,584,347	6,959,013		
Sales Cost		Lead Concentrate NSR US\$ nominal	205,083,195	0	-	-	-	-	-	-	-	-	-	-	9,478,144	9,478,144	12,075,621	11,582,713	10,852,419	10,332,460	44,843,214	39,982,102	35,673,332	39,450,809	35,655,593		
<b>iii) Lead/Silver Middlings</b>																											
Mill Recovery - Ag		%	15.6	16	16	16	16	16	16	16	16	16	16	16	16	16	16	16	16	16	16	16	16	16	16	16	
Contained Metal - Ag Recovered Silver		g oz'000	122,701,819	0	0	0	0	0	0	0	0	0	0	0	4,683,439	4,683,439	5,937,022	5,666,037	5,282,206	5,004,225	21,889,490	18,983,306	16,607,675	18,007,859	15,957,122		
		Payability %	98	98	98	98	98	98	98	98	98	98	98	98	98	98	98	98	98	98	98	98	98	98	98		
Gross Revenue		Gross Value of Lead/Silver Middlings US\$ nominal	58,988,354	-	-	-	-	-	-	-	-	-	-	-	2,726,622	2,726,622	3,473,592	3,331,498	3,121,229	2,971,846	12,897,965	11,498,265	10,260,522	11,348,093	10,256,886		
Sales Cost		Refining Cost US\$ nominal	1,355,680	-	-	-	-	-	-	-	-	-	-	-	62,664	62,664	79,831	76,565	71,723	68,295	296,423	264,255	235,809	260,804	235,725		
		NSR Value (Less: Refining Cost) US\$ nominal	57,632,674	-	-	-	-	-	-	-	-	-	-	-	2,663,958	2,663,958	3,393,761	3,254,933	3,049,496	2,903,551	12,601,542	11,234,010	10,024,713	11,087,289	10,021,161		
		Total Flotation Plant Net Smelter Return US\$ nominal	276,306,374	-	-	-	-	-	-	-	-	-	-	-	12,657,221	12,657,221	16,079,949	15,387,310	14,403,375	13,762,052	59,632,685	53,852,382	48,416,448	53,373,874	48,373,764		

<b>2.3 Total Net Revenue</b>																											
Leach Plant Revenue		US\$ nominal	91,893,742	5,592,686	8,276,466	16,902,932	8,940,260	4,269,662	38,389,321	5,981,047	17,685,161	16,954,392	7,291,136	47,911,736	0	0	0	0	0	0	0	0	0	0	0	0	
Flotation Plant Revenue		US\$ nominal	276,306,374	0	0	0	0	0	0	0	0	0	12,657,221	12,657,221	16,079,949	15,387,310	14,403,375	13,762,052	59,632,685	53,852,382	48,416,448	53,373,874	48,373,764	48,373,764	48,373,764		
Total Revenue		US\$ nominal	368,200,117	5,592,686	8,276,466	16,902,932	8,940,260	4,269,662	38,389,321	5,981,047	17,685,161	16,954,392	19,948,357	60,568,957	16,079,949	15,387,310	14,403,375	13,762,052	59,632,685	53,852,382	48,416,448	53,373,874	48,373,764	48,373,764	48,373,764		

**3. OPERATING COSTS**

<b>3.1 MINING OPEX</b>																											
Open Pit Operating Costs		US\$ nominal	2.15	5.24	1.85	1.87	1.89	1.91	1.91	1.97	1.99	2.01	2.04	2.04	2.38	2.41	2.44	2.47	2.47	2.47	2.14	-	-	-	-	-	
Model 1		t	20,360,927	406,582	734,059	1,659,573	1,654,921	1,655,989	5,704,553	2,024,993	2,047,499	1,159,741	1,159,231	6,391,469	1,215,030	1,228,500	1,242,003	1,242,000	4,927,499	2,930,824	-	-	-	-	-	-	
Open Pit Operating Costs		US\$ nominal	43,867,513	2,128,880	1,356,048	3,101,797	3,129,447	3,168,281	10,755,574	3,981,570	4,073,113	2,334,195	2,360,582	12,749,460	2,897,028	2,963,636	3,031,409	3,067,028	11,959,100	6,274,499	-	-	-	-	-	-	
Leasing Interest		US\$ nominal	590,195	0	81,822	63,065	63,065	63,065	271,017	64,050	44,730	44,730	44,730	198,240	30,235	30,235	30,235	30,235	120,938	0	0	0	0	0	0	0	
Underground Operating Costs		US\$/t nominal	45.69	-	-	-	-	-	-	-	-	-	-	-	255.43	258.44	261.47	264.55	264.55	66.07	39.10	31.80	31.80	39.25	39.25		
Model 1 (Fully owned/operated)		t	840,265	-	-	-	-	-	-	-	-	-	-	-	-	-	-	-	-	17,512	132,583	254,121	273,121	162,929			
Total Mineralised Tonnes		t	38,389,477	-	-	-	-	-	-	-	-	-	-	-	-	-	-	-	-	320,785	982,012	3,310,686	4,613,483	8,759,682			
Underground Operating Costs		US\$ nominal	82,356,990	-	-	-	-	-	-	-	-	-	-	-	264,55	66.07	39.10	31.80	39.25	66.07	39.10	31.80	31.80	39.25			
Total Mining Operating Costs		US\$ nominal	82,256,990	2,128,880	1,356,048	3,101,797	3,129,447	3,168,281	10,755,574	3,981,570	4,073,113	2,334,195	2,360,582	12,749,460	2,897,028	3,284,421	4,013,421	6,377,714	16,572,583	15,034,181	9,937,268	8,683,948	6,395,095	6,395,095			
<b>3.2 PROCESSING OPEX</b>																											
Share of actual material sorted of total ROM Ore Sorting Cost		US\$/nominal/t	71%	2.25	-	2.07	2.09	2.12	2.12	2.21	2.23	2.26	2.28	2.28	2.31	2.34	2.37	2.39	2.39	2.49	2.54	2.59	2.64	2.64	2.64		
Ore Sorting Cost		US\$ nominal	2,889,817	0	66,966	67,752	69,681	204,399	71,435	72,775	73,124	110,863	327,697	112,164	113,481	114,815	116,164	456,624	483,242	492,907	502,765	422,183	422,183	422,183			
Leach Plant (Current Plant)		US\$(2019)/t	72.95	72.95	66.24	67.02	67.81	68.60	68.60	71.49	72.33	73.18	74.04	74.04	74.91	75.79	76.68	77.58	77.58	80.69	82.30	83.95	85.63	85.63			
Unit Processing Cost (Oxides)		US\$(2019)/t	123.71	123.71	112.33	113.65	114.99	116.34	116.34	124.11	122.66	124.11	125.56	127.04	127.04	128.53	131.57	136.83	136.83	136.83	139.57	142.36	145.21	145.21			
Unit Processing Cost (Sulphides)		US\$ nominal	15,158,759	1,461,851	1,980,270	2,012,609	2,036,254	1,694,247	7,723,380	585,190	2,172,167	2,197,690	1,018,481	5,973,529	0	0	0	0	0	0	0	0	0	0			
Oxide Processing Cost		US\$ nominal	3,326,705	0	0																						

90% 10%

Flotation Plant Capital Cost. Choose option >>

- 1. New flotation processing plant, or,
- 2. Retrofitted and upgraded current plant

XRT Component

Processing Capital Cost

US\$ nominal

9,000,000
17,865,257
9,000,000
2,000,000

11,238,257			2,001,655			2,001,655			9,236,602			9,236,602								0
------------	--	--	-----------	--	--	-----------	--	--	-----------	--	--	-----------	--	--	--	--	--	--	--	---

5. Taxes and Depreciation

Depreciation

Disposal of Assets

US\$'000

0																				
---	--	--	--	--	--	--	--	--	--	--	--	--	--	--	--	--	--	--	--	--

1 Group (Average Weighted Standard Rate)

9.50%

Initial Balance																					
Capex	43,006,087	0	1,433,501	2,745,965	747,808	751,348	5,678,622	2,994,757	12,116,735	3,544,217	3,576,709	22,232,418	1,404,012	1,417,236	1,430,610	1,444,137	5,695,995	2,769,104	4,180,416	2,449,531	0
Depreciation	0	9,329,146	8,579,060	8,024,916	7,333,591	7,333,591	33,266,713	6,708,278	6,355,493	6,902,811	6,583,745	26,550,327	6,298,076	5,833,140	5,413,629	5,035,242	22,580,089	4,694,087	4,511,214	4,479,788	4,286,914
Final Balance		98,201,541	90,305,896	84,472,800	77,195,693	70,613,450	70,613,450	66,899,929	72,661,171	69,302,576	66,295,541	66,295,541	61,401,477	56,985,572	53,002,553	49,411,447	49,411,447	47,486,464	47,155,666	45,125,409	40,838,495
Total Depreciation	100,369,132	0	9,329,146	8,579,060	8,024,916	7,333,591	33,266,713	6,708,278	6,355,493	6,902,811	6,583,745	26,550,327	6,298,076	5,833,140	5,413,629	5,035,242	22,580,089	4,694,087	4,511,214	4,479,788	4,286,914

Corporate Income Tax

Income subject to tax

Estimated Income Tax for the period

Allowable reduction of payable tax in the current period

Losses from previous periods as of 2019 in CAD

in USD

Exchanged rate applied

Allowance for carried forward taxes @ 20%

Allowance for carried forward losses O/B

Current period losses allowance (20% applied)

Reduction in tax accounted for carried losses

Allowance for carried forward losses C/B

Payable Income Tax for the period

Savings on tax

Mining Royalty (MET)

Mining Royalty (MET)

33.31 Silver

8.12 Lead

3.57 Zinc

US\$'000

US\$'000

US\$'000

US\$'000

CAD (2019)

USD (2019)

US\$'000

US\$'000

US\$'000

US\$'000

US\$'000

US\$'000

US\$'000

US\$'000 nominal

US\$'000 nominal

US\$'000 nominal

US\$'000 nominal

US\$'000 nominal

US\$'000 nominal

59,156	64	-	352	-	-	352	0	2,077	2,552	4,760	9,389	1,047	339	0	0	1,387	9,276	10,511	16,533	11,644
11,831	13	-	70	-	-	70	-	415	510	952	1,878	209	68	-	-	277	1,855	2,102	3,307	2,329
34,571,789																				
26,618,255																				
1.30																				
6,914,358																				
5,323,651																				
5,324	5,317	6,616	6,581	7,880	7,880	7,880	10,013	12,130	11,922	11,667	11,667	11,191	11,086	11,053	11,247	11,247	11,967	11,040	9,988	8,335
7,763	-	1,299	-	1,299	2,133	4,731	2,117	-	-	-	2,117	-	-	194	720	915	-	-	-	-
-3,587	(6.4)	-	(35.2)	-	-	35	-	(207.7)	(255.2)	(476.0)	939	(104.7)	(33.9)	-	-	139	(927.6)	(1,051.1)	(1,653.3)	1,164.4
5,317	6,616	6,581	7,880	10,013	10,013	10,013	12,130	11,922	11,667	11,191	11,191	11,086	11,053	11,247	11,967	11,967	11,040	9,988	8,335	9,500
8,244	6.4	-	35.2	-	-	35	-	207.7	255.2	476.0	939	104.7	33.9	-	-	139	927.6	1,051.1	1,653.3	3,493.2
3,587																				
44,999	438	647	1,336	706	506	3,195	1,030	1,398	1,340	2,047	5,815	1,972	2,020	1,993	1,952	7,937	8,335	6,614	6,497	6,169
33,310	438	647	1,336	706	506	3,195	1,030	1,398	1,340	1,747	5,515	1,492	1,431	1,340	1,276	5,539	4,938	4,407	4,874	4,405
8,120	0	0	0	0	0	-	0	0	0	189	189	371	510	588	579	2,048	2,597	1,182	809	1,296
3,569	0	0	0	0	0	-	0	0	0	111	111	109	79	65	96	350	800	1,025	814	468

6. Working Capital

Inventories

A/R

A/P

Total Working Capital

Change in Working Capital

US\$'000 nominal

US\$'000 nominal

US\$'000 nominal

US\$'000 nominal

US\$'000 nominal

1,765,933	1,099,885	1,708,145	1,706,561	1,829,500	6,344,091	2,428,881	2,082,711	1,501,633	1,625,944	7,639,169	1,729,838	1,847,421	2,073,945	2,853,901	8,505,106	2,047,485	1,640,302	1,558,344	1,234,850
2,750,501	2,728,505	5,572,395	2,915,302	1,392,281	12,608,484	1,993,682	5,830,273	5,528,606	6,504,899	19,857,460	5,359,983	5,072,740	4,696,753	4,487,626	19,617,101	4,426,223	3,968,561	4,386,894	3,975,926
4,078,225	2,650,756	3,910,971	3,593,654	3,687,355	13,842,737	4,896,930	4,553,504	3,646,173	4,186,830	17,283,437	4,352,247	4,541,794	4,857,360	6,015,645	19,767,046	4,916,973	4,105,904	3,989,723	3,481,102
438,209	1,177,634	3,369,569	1,028,209	-465,574	5,109,838	-474,367	3,359,480	3,384,067	3,944,013	10,213,192	2,737,574	2,378,367	1,913,337	1,325,881	8,355,160	1,556,735	1,502,960	1,955,515	-
438,209	739,425	2,191,935	-2,341,360	-1,493,782	903,783	-8,793	3,833,847	24,587	559,946	4,409,586	-1,206,438	-359,207	-465,030	-587,456	2,618,131	230,853	-53,775	452,555	-1,955,515



		46.51 NPV	@ 8.64%	01-Nov-19	01-Jan-20	01-Apr-20	01-Jul-20	01-Oct-20	01-Jan-20	01-Jan-21	01-Apr-21	01-Jul-21	01-Oct-21	01-Jan-21	01-Jan-22	01-Apr-22	01-Jul-22	01-Oct-22	01-Jan-22	01-Jan-23	01-Jan-24	01-Jan-25	01-Jan-26
End of period				31-Dec-19	31-Mar-20	30-Jun-20	30-Sep-20	31-Dec-20	31-Dec-20	31-Mar-21	30-Jun-21	30-Sep-21	31-Dec-21	31-Dec-21	31-Mar-22	30-Jun-22	30-Sep-22	31-Dec-22	31-Dec-22	31-Dec-23	31-Dec-24	31-Dec-25	31-Dec-26
Project Year		Unit	Total																				
CASH FLOW MODEL		US\$m nominal	US\$'000 nominal	0.17	0.42	0.67	0.92	1.17	1.17	1.42	1.67	1.92	2.17	2.17	2.42	2.67	2.92	3.17	3.17	4.17	5.17	6.17	7.17
0.0%	Gross Revenue	449	4,407,414	5,722	8,467	17,292	9,146	4,368	39,274	6,119	18,093	17,345	22,103	63,466	19,399	19,549	19,023	18,404	76,376	75,604	63,833	66,327	58,679
	Less Realisation Costs	81	(81,273)	(129)	(191)	(389)	(206)	(98)	(885)	(138)	(407)	(391)	(2,155)	(3,091)	(3,319)	(4,162)	(4,620)	(4,642)	(16,743)	(21,752)	(15,417)	(12,951)	(10,305)
	Net Revenue	368	3,682,200	5,593	8,276	16,903	8,940	4,270	38,389	5,981	17,685	16,954	19,948	60,369	16,080	15,387	14,403	13,762	59,633	53,852	48,416	53,374	48,374
	Less Operating Costs																						
0.0%	Less Mining Cost	82.3	(82,257)	(2,129)	(1,356)	(3,102)	(3,129)	(3,168)	(10,756)	(3,982)	(4,073)	(2,334)	(2,361)	(12,769)	(2,897)	(3,284)	(4,013)	(6,378)	(16,573)	(15,034)	(9,937)	(8,664)	(6,395)
0.0%	Less Plant Processing Cost	68.7	(68,703)	(1,462)	(1,980)	(2,080)	(2,104)	(2,421)	(8,406)	(3,305)	(2,344)	(2,271)	(2,626)	(10,445)	(2,392)	(2,319)	(2,347)	(2,374)	(9,331)	(9,877)	(10,074)	(10,276)	(8,629)
	Less G&A	46.7	(46,733)	(1,500)	(1,377)	(1,392)	(1,407)	(1,421)	(5,598)	(1,477)	(1,493)	(1,510)	(1,526)	(6,006)	(1,543)	(1,560)	(1,572)	(1,595)	(6,276)	(6,366)	(6,769)	(6,905)	(7,043)
	Less Mining Royalty Tax	45.0	(44,999)	(438)	(647)	(1,336)	(706)	(506)	(3,195)	(1,030)	(1,398)	(1,340)	(2,047)	(5,815)	(1,972)	(2,020)	(1,993)	(1,952)	(7,937)	(8,335)	(6,614)	(6,497)	(6,169)
	Total Operating Cost LOM	242.7	(242,691)	(5,528)	(5,360)	(7,909)	(7,347)	(7,539)	(28,155)	(9,794)	(9,208)	(7,454)	(8,560)	(35,016)	(8,704)	(9,185)	(9,931)	(12,299)	(40,118)	(39,882)	(33,395)	(32,361)	(28,236)
	EBITDA	125.5	125,509	64	2,916	8,994	1,593	(3,269)	10,234	(8,813)	8,477	9,500	11,389	25,553	7,375	6,203	4,473	1,463	19,514	13,970	15,022	21,113	20,138
	Less Interest Cost (Leasing)	0.6	(590)	--	(82)	(63)	(63)	(63)	(2,711)	(64)	(45)	(45)	(45)	(1,981)	(30)	(30)	(30)	(30)	(1,211)	--	--	--	--
	Less Depreciation & Amortisation	100.4	(100,369)	--	(9,329)	(8,579)	(8,025)	(7,334)	(33,267)	(6,708)	(6,355)	(6,903)	(6,584)	(26,550)	(6,298)	(5,833)	(5,414)	(5,035)	(22,580)	(4,694)	(4,511)	(4,887)	(4,287)
	Less Payments to Reclamation Fund	4.2	(4,207)	--	--	--	--	--	--	--	--	--	--	--	--	--	--	--	--	--	--	--	(4,207)
	EBT	20.3	20,343	64	(6,495)	352	(6,495)	(10,666)	(23,303)	(10,585)	2,077	2,552	4,760	(1,196)	1,047	339	(971)	(3,602)	(3,187)	9,276	10,511	16,533	11,644
	Less Income Tax (carried forward losses considered)	8.2	(8,244)	(6)	--	(35)	--	--	(35)	--	(208)	(255)	(476)	(939)	(105)	(34)	--	--	(139)	(928)	(1,051)	(1,653)	(3,493)
	Net Income	12	12,098	58	(6,495)	317	(6,495)	(10,666)	(23,338)	(10,585)	1,869	2,297	4,284	(2,135)	942	305	(971)	(3,602)	(3,325)	8,349	9,459	14,880	8,151
	Plus Depreciation & Amortisation	100	100,369	--	9,329	8,579	8,025	7,334	33,267	6,708	6,355	6,903	6,584	26,550	6,298	5,833	5,414	5,035	22,580	4,694	4,511	4,480	4,287
	Less Increase in Net Working Capital	0	--	(438)	(739)	(2,192)	2,341	1,494	904	9	(3,834)	(25)	(560)	(4,410)	1,206	359	465	587	2,618	(231)	54	(453)	1,956
	Cash Flow from Operations	112	112,467	(880)	2,095	6,704	3,872	(1,838)	10,832	(3,868)	4,391	9,175	10,308	20,006	8,447	6,498	4,908	2,021	21,873	12,812	14,024	18,907	14,393
0.0%	Less Capital Costs, Including	43.0	(43,006)	--	(1,434)	(2,246)	(248)	(751)	(5,679)	(2,995)	(12,117)	(3,544)	(3,577)	(22,232)	(1,404)	(1,417)	(1,431)	(1,444)	(5,696)	(2,769)	(4,180)	(2,450)	--
	Mining Capex for Open Pit	2.5	(2,473)	--	(294)	(298)	(301)	(305)	(1,198)	--	--	(636)	(639)	--	--	--	--	--	--	--	--	--	--
	Mining Capex for Underground	24.6	(24,595)	--	--	--	--	--	--	(2,541)	(2,569)	(2,626)	(2,626)	(10,334)	(1,196)	(1,209)	(1,222)	(1,236)	(4,862)	(2,769)	(4,180)	(2,450)	--
	Leasing Principal Repayment	4.7	(4,700)	--	(1,139)	(447)	(447)	(447)	(2,479)	(454)	(311)	(311)	(311)	(1,387)	(208)	(208)	(208)	(208)	(834)	--	--	--	--
	Processing Plant Upgrade: XRT and Flotation Plant	11.2	(11,238)	--	--	(2,002)	--	--	(2,002)	--	(9,237)	--	--	(9,237)	--	--	--	--	--	--	--	--	--
	Pre Tax Cash Flow	78	77,706	(374)	661	3,993	3,124	(2,590)	5,189	(8,663)	(7,518)	5,886	7,207	(1,287)	7,148	5,115	3,477	576	16,316	10,970	10,895	18,111	17,886
	Post Tax Free Cash Flow	69	69,461	(880)	661	3,958	3,124	(2,590)	5,153	(8,683)	(7,726)	5,631	6,731	(2,226)	7,043	5,081	3,477	576	16,177	10,403	9,844	16,457	14,393
	Cumulative Project Cash Flow		281,813	(388)	281	4,239	7,363	4,773	4,773	(2,090)	(9,816)	(4,184)	2,547	2,547	9,590	14,670	18,147	18,724	38,724	38,766	38,610	55,068	69,461
8.64%	Discount Factor			0.99	0.97	0.95	0.93	0.91	0.91	0.89	0.87	0.85	0.84	0.84	0.82	0.80	0.79	0.77	0.77	0.71	0.65	0.60	0.55
	Discounted Cash Flow	47	46,508	(375)	639	3,745	2,895	(2,351)	4,928	(6,103)	(6,729)	4,804	5,625	(2,403)	5,765	4,073	2,730	443	13,012	7,110	6,615	9,872	7,948
	Cumulative Discounted Cash Flow		211,884	(375)	264	4,009	6,904	4,553	4,553	(1,549)	(8,279)	(3,474)	2,150	2,150	7,915	11,988	14,719	15,162	38,724	38,688	38,561	46,508	
	Discount Factor			0.98	0.96	0.94	0.92	0.89	0.89	0.87	0.85	0.83	0.81	0.81	0.79	0.78	0.76	0.74	0.74	0.67	0.61	0.56	0.51
10.00%	Discounted Cash Flow	44	43,874	(374)	636	3,714	2,862	(2,317)	4,895	(5,996)	(6,591)	4,691	5,475	(2,411)	5,594	3,940	2,633	426	12,594	6,751	6,016	9,143	7,270
	Discount Factor			0.98	0.94	0.91	0.88	0.85	0.85	0.82	0.79	0.77	0.74	0.74	0.71	0.69	0.67	0.64	0.64	0.56	0.49	0.42	0.37
15.00%	Discounted Cash Flow	36	35,772	(371)	624	3,606	2,748	(2,200)	4,778	(5,630)	(6,121)	4,308	4,973	(2,470)	5,024	3,500	2,313	370	11,207	5,610	4,782	6,951	5,286
	Discount Factor			0.97	0.93	0.89	0.85	0.81	0.81	0.77	0.74	0.71	0.67	0.67	0.64	0.61	0.59	0.56	0.56	0.47	0.39	0.32	0.27
20.0%	Discounted Cash Flow	30	29,605	(369)	613	3,505	2,643	(2,093)	4,667	(5,301)	(5,701)	3,970	4,535	(2,497)	4,533	3,124	2,043	324	10,024	4,698	3,838	5,347	3,897

Financial Project Summary		
NPV @ Discount Rate of 8.64%	US\$ M	46.51
IRR	%	11.86%
Payback period of capital (Discounted)	Years	03.2021
Max Cash Exposure	US\$ M	0.38
NPV @ Discount Rate of 10%	US\$ M	43.87
NPV @ Discount Rate of 15%	US\$ M	35.77
NPV @ Discount Rate of 20%	US\$ M	29.60
Ag Break-even price		14.11

(375)

4,928

(2,403)

13,012

7,110

6,415

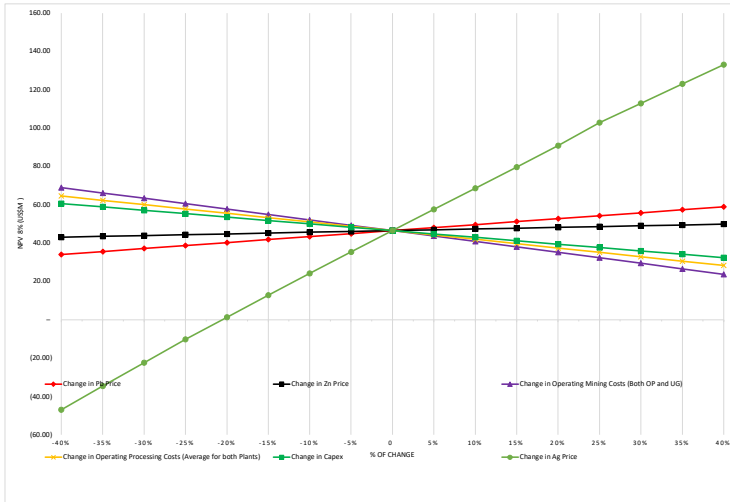
9,872

7,948

0%
0%
0%
0%
0%
0%

**Sensitivity Analysis**

Pb Price  
 Zn Price  
 Operating Mining Costs (Both OP and UG)  
 Operating Processing Costs (Average for both Plants)  
 Capex  
 Ag Price



Change in Pb Price																		
Nominal Values	1,241	1,345	1,448	1,553	1,655	1,759	1,863	1,966	2,069	2,172	2,276	2,379	2,483	2,586	2,690	2,793	2,897	
Base Case	-40%	-35%	-30%	-25%	-20%	-15%	-10%	-5%	0	5%	10%	15%	20%	25%	30%	35%	40%	
NPV @ 8%	46.5	34.01	35.57	37.14	38.71	40.27	41.84	43.40	44.95	46.51	48.06	49.62	51.17	52.72	54.28	55.83	57.37	58.91
Change in Ag Price																		
g/t	nominal Values	10.66	11.54	12.43	13.32	14.21	15.10	15.98	16.87	17.76	18.65	19.54	20.42	21.31	22.20	23.09	23.98	24.86
Base Case	-40%	-35%	-30%	-25%	-20%	-15%	-10%	-5%	0	5%	10%	15%	20%	25%	30%	35%	40%	
NPV @ 8%	46.5	(46.83)	(34.57)	(22.36)	(10.30)	1.33	12.78	24.10	35.35	46.51	57.57	68.60	79.61	90.87	102.84	112.96	123.09	133.14
Change in Zn Price																		
Nominal Values	1,351	1,464	1,576	1,689	1,802	1,914	2,027	2,139	2,252	2,365	2,477	2,590	2,702	2,815	2,815	2,815	2,815	
Base Case	-40%	-35%	-30%	-25%	-20%	-15%	-10%	-5%	0	5%	10%	15%	20%	25%	30%	35%	40%	
NPV @ 8%	46.5	43.1	43.5	44.0	44.4	44.8	45.2	45.7	46.1	47	46.9	47.4	47.8	48.2	48.6	49.0	49.5	49.9
Change in Operating Mining Costs (Both OP and UG)																		
Mining Opex (\$/t ore mir	29.69	32.17	34.64	37.12	39.59	42.07	44.54	47.02	49.49	51.96	54.44	56.91	59.39	61.86	64.34	66.81	69.29	
Base Case	-40%	-35%	-30%	-25%	-20%	-15%	-10%	-5%	0	5%	10%	15%	20%	25%	30%	35%	40%	
NPV @ 8%	46.5	69.0	66.2	63.4	60.6	57.8	55.0	52.1	49.3	47	43.7	40.9	38.0	35.2	32.3	29.5	26.6	23.7
Change in Operating Processing Costs (Average for both Plants)																		
Proc Opex (\$/t ore)	24.88	26.87	28.93	31.00	33.07	35.13	37.20	39.27	41.33	43.40	45.47	47.54	49.60	51.67	53.74	55.80	57.87	
Base Case	-40%	-35%	-30%	-25%	-20%	-15%	-10%	-5%	0	5%	10%	15%	20%	25%	30%	35%	40%	
NPV @ 8%	46.5	64.6	62.3	60.1	57.8	55.5	53.3	51.0	48.8	47	44.2	42.0	39.7	37.4	35.2	32.9	30.6	28.3
Change in Capex																		
Capex (US\$M)	35.8	28.0	30.1	32.3	34.4	36.6	38.7	40.9	43.0	45.2	47.3	49.5	51.6	53.8	55.9	58.1	60.2	
Base Case	-40%	-35%	-30%	-25%	-20%	-15%	-10%	-5%	0	5%	10%	15%	20%	25%	30%	35%	40%	
NPV @ 8%	46.5	60.6	58.8	57.1	55.3	53.6	51.8	50.0	48.3	47	44.7	43.0	41.2	39.5	37.7	35.9	34.2	32.4

	60%	75%	90%	100%	110%	125%	140%
Pb Price	1,241	1,352	1,462	2,069	2,276	2,586	2,897
NPV @ 8.64%	29.56	33.96	38.36	41.30	44.23	48.63	53.01
Zn Price	1,351	1,689	2,027	2,252	2,477	2,815	2,815
NPV @ 8.64%	43.12	44.39	45.66	46.51	47.35	48.62	49.89
Operating Mining Costs (Both OP and UG)	29.69	37.12	44.54	49.49	54.44	61.86	69.29
NPV @ 8.64%	68.98	60.58	52.14	46.51	40.86	32.31	23.73
Operating Processing Costs (Average for both Plants)	24.80	31.00	37.20	41.33	45.47	51.67	57.87
NPV @ 8.64%	64.58	57.80	51.02	46.51	41.98	35.15	28.30
Capex (US\$ M, nominal)	25.80	32.25	38.71	43.01	47.31	53.76	60.21
NPV @ 8.64%	60.61	55.32	50.03	46.51	42.98	37.69	32.40
Ag Price	10.66	13.32	15.98	17.76	19.54	22.20	24.86
NPV @ 8.64%	- 46.89	- 10.30	24.10	46.51	68.60	102.84	133.14

YEAR		2019	2020					2021					2022					2023	2024	2025	2026		
PERIOD START			01-Jan-20	01-Apr-20	01-Jul-20	01-Oct-20	Y20	01-Jan-21	01-Apr-21	01-Jul-21	01-Oct-21	Y21	01-Jan-22	01-Apr-22	01-Jul-22	01-Oct-22	Y22	Y23	Y24	Y25	Y26		
PROJECT PERIOD		19 Q4	20 Q1	20 Q2	20 Q3	20 Q4		21 Q1	21 Q2	21 Q3	21 Q4		22 Q1	22 Q2	22 Q3	22 Q4		Y23	Y24	Y25	Y26		
<b>1. PRODUCTION SCHEDULE</b>																							
<b>1.1 Mining Physicals</b>																							
<b>Vertikally Open Pit</b>																							
Mineralised Material	t	402,843	23,640	30,717	48,836	51,169	44,893	175,615	36,024	61,350	83,413	22,801	203,588	-	-	-	-	-	-	-	-		
Waste Material	t	10,995,762	382,943	703,343	1,610,736	1,603,752	1,611,106	5,528,938	1,988,975	1,986,149	846,328	262,430	5,083,882	-	-	-	-	-	-	-	-		
<b>Mangazeyksky North Open Pit</b>																							
Mineralised Material	t	418,996	-	-	-	-	-	-	-	8,559	29,345	37,904	52,148	50,147	68,340	73,335	243,970	137,121	-	-	-		
Waste Material	t	8,543,326	-	-	-	-	-	-	-	221,441	844,655	1,066,096	1,162,851	1,178,353	1,173,660	1,168,664	4,683,528	2,793,702	-	-	-		
<b>Vertikally Underground Mining</b>																							
Mineralised Material	t	840,265	-	-	-	-	-	-	-	-	-	-	-	1,241	3,756	12,515	17,512	132,583	254,121	273,121	162,929		
<b>Vertikally Underground Development</b>																							
Decline	m	7,411	-	-	-	-	-	-	-	-	-	-	-	269	638	580	1,487	2,192	2,343	1,389	-		
Level Access	m	9,982	-	-	-	-	-	-	-	-	-	-	-	153	190	576	919	3,650	3,532	1,784	97		
Vent Connection	m	1,061	-	-	-	-	-	-	-	-	-	-	-	13	91	72	175	261	450	175	-		
<b>1.2 Ore Sorter Feed</b>																							
<b>Leach Plant (Current)</b>																							
Oxide	t	302,594	20,039	29,894	45,500	45,500	37,418	158,311	12,402	45,500	45,500	20,841	124,243	-	-	-	-	-	-	-	-		
Ag	g/t	588	581	783	412	177	495	393	803	766	716	734	-	-	-	-	-	-	-	-	-		
Sulphide	t	41,931	-	-	-	-	8,833	33,098	-	-	-	33,098	-	-	-	-	-	-	-	-	-		
Ag	g/t	762	-	-	-	-	762	671	-	-	671	-	-	-	-	-	-	-	-	-	-		
Oxide + Sulphide	t	344,525	20,039	29,894	45,500	45,500	46,251	167,145	45,500	45,500	20,841	157,341	-	-	-	-	-	-	-	-	-		
<b>Flotation Plant</b>																							
Sulphide	t	1,362,739	-	-	-	-	-	-	-	-	47,340	47,340	68,180	68,180	68,180	68,180	272,720	272,720	272,720	272,720	224,519		
Ag	g/t	641	-	-	-	-	-	-	-	-	641	641	564	538	502	475	520	451	394	428	460		
Pb	%	2	-	-	-	-	-	-	-	-	2	2	3	4	5	5	4	5	2	2	3		
Zn	%	1	-	-	-	-	-	-	-	-	1	1	1	1	1	1	1	2	2	1	1		
<b>1.3 Process Plant Feed</b>																							
<b>Leach Plant (Current)</b>																							
Oxide	t	216,689	20,039	29,894	30,030	30,030	24,696	114,650	8,185	30,030	30,030	13,755	82,001	-	-	-	-	-	-	-	-		
Ag	g/t	588	581	1,175	618	266	678	589	1,205	1,150	1,074	1,101	-	-	-	-	-	-	-	-	-		
Sulphide	t	27,675	-	-	-	-	5,830	21,845	-	-	-	21,845	-	-	-	-	-	-	-	-	-		
Ag	g/t	1,143	-	-	-	-	1,143	1,007	-	-	1,007	-	-	-	-	-	-	-	-	-	-		
Oxide + Sulphide	t	244,364	20,039	29,894	30,030	30,030	30,526	120,479	30,030	30,030	13,755	103,845	-	-	-	-	-	-	-	-	-		
<b>Flotation Plant (Available in mid 2021)</b>																							
Sulphide	t	899,408	-	-	-	-	-	-	-	-	31,244	31,244	44,999	44,999	44,999	44,999	179,995	179,995	179,995	179,995	148,182		
Ag	g/t	961	-	-	-	-	-	-	-	-	961	961	846	807	752	713	780	676	591	641	690		
Pb	%	3	-	-	-	-	-	-	-	-	3	3	5	6	7	7	6	8	5	4	3		
Zn	%	2	-	-	-	-	-	-	-	-	2	2	1	1	1	1	1	2	3	3	3		
<b>3. MINING COSTS</b>																							
<b>3.1 Open Pit Operating Costs</b>																							
Provided costs as WAI has incorpn			0.50				0.40					0.40					0.37	0.36	-	-	-		
Drilling	\$/t		0.45				0.46					0.46					0.46	0.46	-	-	-		
Blasting	\$/t		0.51				0.12					0.11					0.14	0.07	-	-	-		
Dozing & Grading	\$/t		1.22				0.32					0.31					0.36	0.28	-	-	-		
Loading & Stockpiling	\$/t		0.81				0.51					0.54					0.74	0.72	-	-	-		
Hauling	\$/t		-				-					-					-	-	-	-	-		
Conveyor	\$/t		0.63				0.05					0.04					0.05	0.00	-	-	-		
Engineering/Geology	\$/t		0.52				0.13					0.11					0.14	0.04	-	-	-		
General Mine Maintenance	\$/t		0.56				0.04					0.04					0.05	0.02	-	-	-		
Supervision & Technical	\$/t		0.10				0.04					0.04					0.05	0.02	-	-	-		
Other	\$/t		-				-					-					-	-	-	-	-		
Pumping	\$/t		-				-					-					-	-	-	-	-		
99% Model 1	US\$/t <sup>moved</sup>		5.24	2.03	2.03	2.03	2.03	2.01	2.01	2.01	2.01	2.01	2.32	2.32	2.32	2.32	2.32	1.94	-	-	-		
Total	\$/t ore		91.32				67.01					53.84					47.55	41.95	-	-	-		
Total	\$/t Hard Rock Waste		5.64				2.13					2.11					2.48	2.06	-	-	-		
Total Moved Tonnes	t		20,360,927	406,582	734,059	1,659,573	1,654,921	1,655,999	5,704,553	2,024,999	2,047,499	1,159,741	1,159,231	6,391,469	1,215,000	1,228,500	1,242,000	1,242,000	4,927,499	2,930,824	-		
Open Pit Operating Costs	US\$		43,671,143	2,128,880	1,493,364	3,376,221	3,366,758	3,368,951	11,605,294	4,062,702	4,107,843	2,326,758	2,325,734	12,823,037	2,821,113	2,852,458	2,883,804	2,883,804	11,441,180	5,672,752	-		
<b>3.2 Underground Operating Costs</b>																							
Operating Development	\$/t ore		-				-					-	15.38	15.38	15.38	15.38	15.38	11.28	6.85	4.43	2.82		
Operating Expenditure	\$/t ore		-				-					-	184.96	184.96	184.96	184.96	184.96	31.99	18.63	15.48	20.15		
Personnel Salaries	\$/t ore		-				-					-	48.40	48.40	48.40	48.40	48.40	16.46	9.18	7.71	10.47		
Model 1 (Fully owned/operated)	US\$/t <sub>ore</sub>		-				-					-	248.74	248.74	248.74	248.74	248.74	59.73	34.66	27.63	33.44		
Total Mineralised Tonnes	t		840,265	-	-	-	-	-	-	-	-	-	-	1,241	3,756	12,515	17,512	132,583	254,121	273,121	162,929		
Underground Operating Costs	US\$		34,078,098	-	-	-	-	-	-	-	-	-	-	308,751	934,196	3,112,906	4,355,854	7,919,597	8,808,087	7,546,257	5,448,303		
<b>3.3 Total Operating Costs</b>																							
Open Pit Operating Costs	US\$		43,671,143	2,128,880	1,493,364	3,376,221	3,366,758	3,368,951	11,605,294	4,062,702	4,107,843	2,326,758	2,325,734	12,823,037	2,821,113	2,852,458	2,883,804	2,883,804	11,441,180	5,672,752	-		
Underground Operating Costs	US\$		-	-	-	-	-	-	-	-	-	-	-	-	308,751	934,196	3,112,906	4,355,854	7,919,597	8,808,087	7,546,257		
Total Operating Costs	US\$		77,749,241	2,128,880	1,493,364	3,376,221	3,366,758	3,368,951	11,605,294	4,062,702	4,107,843	2,326,758	2,325,734	12,823,037	2,821,113	3,161,210	3,818,000	5,996,711	15,797,034	13,592,349	8,808,087	7,546,257	5,448,303
<b>3.5 Underground Capital Cost Schedule</b>																							
<b>3.6 Total Capital Expenditure</b>																							
CAPEX Open Pit	US\$		2,530,102	-	324,068	324,068	324,068	324,068	1,296,272	-	-	616,915	616,915	1,233,831	-	-	-	-	-	-	-		
CAPEX Underground	US\$		23,327,643	-	-	-	-	-	-	2,580,949	2,580,949	2,580,949	2,580,949	10,323,797	1,162,110	1,162,110	1,162,110	1,162,110	4,648,439	2,508,900	3,713,329	2,133,176	
CAPEX Total	US\$		25,857,745	-	324,068	324,068	324,068	324,068	1,296,272	2,580,949	2,580,949	3,197,865	3,197,865	11,557,628	1,162,110	1,162,110	1,162,110	1,162,110	4,648,439	2,508,900	3,713,329	2,133,176	
<b>OPEN PIT CAPITAL COST SCHEDULE</b>																							



YEAR PERIOD START PROJECT PERIOD	TOTAL	2019 01-Nov-19 19 Q4	01-Jan-20 20 Q1	01-Apr-20 20 Q2	2020 01-Jul-20 20 Q3	01-Oct-20 20 Q4	01-Jan-20 Y20	2021 01-Jan-21 21 Q1	01-Apr-21 21 Q2	01-Jul-21 21 Q3	01-Oct-21 21 Q4	01-Jan-21 Y21	2022 01-Jan-22 Y22	2023 01-Jan-23 Y23	2024 01-Jan-24 Y24	2025 01-Jan-25 Y25	2026 01-Jan-26 Y26
--	-------	----------------------------	--------------------	--------------------	----------------------------	--------------------	------------------	----------------------------	--------------------	--------------------	--------------------	------------------	--------------------------	--------------------------	--------------------------	--------------------------	--------------------------

### 1. VERTIKALNY OP

Oxide (NSR>=117 US\$/t)	t	212,438	15,939	23,213	38,184	20,092	6,100	87,689	8,203	45,352	50,961	4,395	108,910	-	-	-	-
Ag	g/t	800	716	714	913	778	331	789	541	912	811	527	821	-	-	-	-
Oxide (NSR<117 US\$/t)	t	44,996	4,100	6,682	6,658	11,434	790	25,563	4,199	7,032	4,102	-	15,333	-	-	-	-
Ag	g/t	104	92	116	101	91	89	100	103	103	144	-	114	-	-	-	-
Sulphide (NSR>=113.06 US\$/t)	t	116,362	3,451	822	2,845	14,495	29,017	47,179	16,824	7,298	24,333	17,276	65,732	-	-	-	-
Ag	g/t	846	814	802	2,328	1,758	430	959	586	413	1,105	617	767	-	-	-	-
Pb	%	1.70	0.95	0.64	2.34	1.91	1.48	1.65	1.55	1.94	1.67	2.12	1.79	-	-	-	-
Zn	%	1.66	2.37	2.03	0.92	1.46	1.49	1.46	1.21	2.80	1.60	2.08	1.76	-	-	-	-
Sulphide (NSR<113.06 US\$/t)	t	29,047	160	-	1,150	5,148	8,987	15,285	6,797	1,668	4,018	1,130	13,613	-	-	-	-
Ag	g/t	131	136	-	63	154	153	147	119	126	107	93	114	-	-	-	-
Pb	%	0.98	0.32	-	0.21	0.65	0.97	0.81	0.85	3.04	0.83	1.82	1.19	-	-	-	-
Zn	%	1.36	0.34	-	1.18	1.69	0.68	1.04	1.27	3.25	2.02	1.10	1.72	-	-	-	-
Total Mineralised Material	t	402,843	23,640	30,717	48,836	51,169	44,893	175,615	36,024	61,350	83,413	22,801	203,588	-	-	-	-
Waste	t	10,995,762	382,943	703,343	1,610,736	1,603,752	1,611,106	5,528,938	1,988,975	1,986,149	846,328	262,430	5,863,882	-	-	-	-

### 2. MANGAZEISKY NORTH OP

Sulphide (NSR>=113.06 US\$/t)	t	346,794	-	-	-	-	-	-	-	5,600	26,526	32,126	199,371	115,297	-	-	-
Ag	g/t	570	-	-	-	-	-	-	-	408	527	507	554	617	-	-	-
Pb	%	7.47	-	-	-	-	-	-	-	3.26	5.18	4.84	6.35	10.16	-	-	-
Zn	%	0.82	-	-	-	-	-	-	-	0.05	0.09	0.08	0.40	1.75	-	-	-
Sulphide (NSR<113.06 US\$/t)	t	72,201.61	-	-	-	-	-	-	-	2,959	2,819	5,778	44,599	21,824	-	-	-
Ag	g/t	129	-	-	-	-	-	-	-	194	125	161	125	128	-	-	-
Pb	%	1.38	-	-	-	-	-	-	-	0.79	0.30	0.55	1.51	1.33	-	-	-
Zn	%	0.37	-	-	-	-	-	-	-	0.02	0.01	0.01	0.16	0.90	-	-	-
Total Mineralised Material	t	418,996	-	-	-	-	-	-	-	8,559	29,345	37,904	243,970	137,121	-	-	-
Waste	t	8,543,326	-	-	-	-	-	-	-	-	221,441	844,655	1,066,096	4,683,528	2,793,702	-	-

### 3. VERTIKALNY UG

Waste Development	t	284,155	-	-	-	-	-	-	-	-	-	-	55,390	81,247	92,781	54,738	-
Development Mineralised Material	t	231,658	-	-	-	-	-	-	-	-	-	-	17,512	89,320	82,009	40,223	2,584
Ag	g/t	263	-	-	-	-	-	-	-	-	-	-	281	269	231	306	239
Pb	%	1.37	-	-	-	-	-	-	-	-	-	-	1.34	1.17	1.17	1.35	1.13
Zn	%	1.26	-	-	-	-	-	-	-	-	-	-	2.35	1.53	0.84	1.07	0.72
Slope Mineralised Tonnes	t	608,607	-	-	-	-	-	-	-	-	-	-	43,263	172,111	232,897	160,335	-
Ag	g/t	462	-	-	-	-	-	-	-	-	-	-	457	452	466	468	-
Pb	%	2.16	-	-	-	-	-	-	-	-	-	-	2.39	1.65	1.51	1.57	-
Zn	%	1.68	-	-	-	-	-	-	-	-	-	-	2.95	2.50	1.35	0.92	-
Total Mineralised Tonnes	t	840,265	-	-	-	-	-	-	-	-	-	-	17,512	132,583	254,121	273,121	162,929
Ag	g/t	407	-	-	-	-	-	-	-	-	-	-	281	331	381	442	465
Pb	%	1.95	-	-	-	-	-	-	-	-	-	-	1.34	1.57	1.56	1.57	3.56
Zn	%	1.56	-	-	-	-	-	-	-	-	-	-	2.35	1.99	1.97	1.31	0.92
Inclined	m	7,411	-	-	-	-	-	-	-	-	-	-	1,487	2,192	2,343	1,389	-
Horizontal	m	9,982	-	-	-	-	-	-	-	-	-	-	919	3,650	3,532	1,784	97
Vertical	m	1,061	-	-	-	-	-	-	-	-	-	-	175	261	450	175	-

### 4. STOCKPILES

OFF-BALANCE OXIDE																	
Open Balance																	
Mass	t	-	-	45,160	44,502	30,528	45,160	-	-	-	-	-	-	-	-	-	-
Ag	g/t	-	-	149	149	149	149	-	-	-	-	-	-	-	-	-	-
Ag Contained	kg	-	-	6,709	6,612	4,536	6,709	-	-	-	-	-	-	-	-	-	-
Input																	
Mass	t	-	-	-	-	-	-	-	-	-	-	-	-	-	-	-	-
Ag	g/t	-	-	-	-	-	-	-	-	-	-	-	-	-	-	-	-
Ag Contained	kg	-	-	-	-	-	-	-	-	-	-	-	-	-	-	-	-
Output (Ore Sorter Leach Plant Stream)																	
Mass	t	-	-	658	13,974	30,528	45,160.00	-	-	-	-	-	-	-	-	-	-
Ag	g/t	-	-	149	149	149	148.57	-	-	-	-	-	-	-	-	-	-
Ag Contained	kg	-	-	98	2,076	4,536	6,709.42	-	-	-	-	-	-	-	-	-	-
Closing Balance																	
Mass	t	-	-	44,502	30,528	-	-	-	-	-	-	-	-	-	-	-	-
Ag	g/t	-	-	149	149	-	-	-	-	-	-	-	-	-	-	-	-
Ag Contained	kg	-	-	6,612	4,536	-	-	-	-	-	-	-	-	-	-	-	-
ROM OXIDE																	
Open Balance																	
Mass	t	-	-	-	-	-	-	-	6,884	16,446	-	-	-	-	-	-	-
Ag	g/t	-	-	-	-	-	-	-	803	766	-	-	-	-	-	-	-
Ag Contained	kg	-	-	-	-	-	-	-	5,530	12,603	-	-	-	-	-	-	-
Input																	
Mass	t	20,039	29,894	44,842	31,526	6,890	113,151	12,402	52,384	55,062	4,395	124,243	-	-	-	-	-
Ag	g/t	588	581	792	529	303	633	393	803	762	527	734	-	-	-	-	-
Ag Contained	kg	11,789	17,359	35,536	16,678	2,089	71,663	4,871	42,082	41,942	2,318	91,213	-	-	-	-	-
Output (Ore Sorter Leach Plant Stream)																	
Mass	t	20,039	29,894	44,842	31,526	6,890	113,151	12,402	45,500	45,500	20,841	124,243	-	-	-	-	-
Ag	g/t	588	581	792	529	303	633.34	393	803	766	716	734.15	-	-	-	-	-
Ag Contained	kg	11,789	17,359	35,536	16,678	2,089	71,663	4,871	36,552	34,869	14,921	91,212.69	-	-	-	-	-
Closing Balance																	
Mass	t	-	-	-	-	-	-	-	6,884	16,446	-	-	-	-	-	-	-
Ag	g/t	-	-	-	-	-	-	-	803	766	-	-	-	-	-	-	-
Ag Contained	kg	-	-	-	-	-	-	-	5,530	12,603	-	-	-	-	-	-	-
ROM SULPHIDE																	
Open Balance																	
Mass	t	-	3,601	4,423	8,418	28,061	3,601	57,231	47,755	56,721	93,631	57,231	94,042	82,804	79,788	61,189	61,590
Ag	g/t	-	786.15	789	1,210	1,300	786.15	762	671	622	699	762	641	475	429	382	449
Ag Contained	kg	-	2,831	3,490	10,186	36,467	2,831	43,600	32,050	35,273	65,461	43,600	60,242	39,352	34,210	23,397	27,633
Pb	%	-	0.92	0.87	1.27	1.49	0.92	1.41	1.39	1.51	1.61	1.41	2.31	4.84	4.50	1.76	1.66
Pb Contained	kg	-	33,094	38,349	107,215	418,098	33,094	808,571	665,186	857,727	1,503,581	808,571	2,176,204	4,003,841	3,591,118	1,078,340	1,021,249
Zn	%	-	2.29	2.24	1.65	1.56	2.29	1.41	1.35	1.60	1.41	1.26	0.74	1.71	1.97	1.25	1.25
Zn Contained	kg	-	82,384	99,088	138,929	437,262	82,384	805,526	646,619	905,506	1,379,671	805,526	1,180,852	612,623	1,365,812	1,207,886	771,311
Input																	
Mass	t	3,601	822	3,995	19,643	38,003	62,464	23,622	8,966	36,910	47,751	117,249	261,482	269,704	254,121	273,121	162,929
Ag	g/t	786	802	1,676	1,338	365	760	451	359	618	526	590	462	437	381	442	465

Pb Contained	kg		-	-	-	-	-	-	-	-	-	1,095,489	1,095,489	11,733,774	14,494,470	6,468,896	4,340,458	6,814,913
Zn	%		-	-	-	-	-	-	-	-	-	1.26	1.26	0.68	1.50	1.89	1.47	1.01
Zn Contained	kg		-	-	-	-	-	-	-	-	-	594,435	594,435	1,846,449	4,100,288	5,153,549	4,011,934	2,262,614
<b>Closing Balance</b>																		
Mass	t		3,601	4,423	8,418	28,061	57,231	57,231	47,755	56,721	93,631	94,042	94,042	82,804	79,788	61,189	61,590	-
Ag	g/t		786	789	1,210	1,300	762	762	671	622	699	641	641	475	429	382	449	-
Ag Contained	kg		2,831	3,490	10,186	36,467	43,600	43,600	32,050	35,273	65,461	60,242	60,242	39,352	34,210	23,397	27,633	-
Pb	%		0.92	0.87	1.27	1.49	1.41	1.41	1.39	1.51	1.61	2.31	2.31	4.84	4.50	1.76	1.66	-
Pb Contained	kg		33,094	38,349	107,215	418,098	808,571	808,571	665,186	857,727	1,503,581	2,176,204	2,176,204	4,003,841	3,591,118	1,078,340	1,021,249	-
Zn	%		2.29	2.24	1.65	1.56	1.41	1.41	1.35	1.60	1.47	1.26	1.26	0.74	0.74	1.25	1.25	-
Zn Contained	kg		82,384	99,088	138,929	437,262	805,526	805,526	646,619	905,506	1,379,671	1,180,852	1,180,852	612,623	1,365,812	1,207,886	771,311	-

5. ORE SORTER FEED

LEACH PLANT STREAM																		
<b>Off Balance Oxide</b>																		
Mass	t	45,160	-	-	658	13,974	30,528	45,160	-	-	-	-	-	-	-	-	-	-
Ag	g/t	149	-	-	149	149	149	149	-	-	-	-	-	-	-	-	-	-
Ag Contained	kg	6,709	-	-	98	2,076	4,536	6,709	-	-	-	-	-	-	-	-	-	-
<b>ROM Oxide</b>																		
Mass	t	257,434	20,039	29,894	44,842	31,526	6,890	113,151	12,402	45,500	45,500	20,841	124,243	-	-	-	-	-
Ag	g/t	678	588	581	792	529	303	633	393	803	766	716	734	-	-	-	-	-
Ag Contained	kg	174,665	11,789	17,359	35,536	16,678	2,089	71,663	4,871	36,552	34,869	14,921	91,213	-	-	-	-	-
<b>Total Oxide</b>																		
Mass	t	302,594	20,039	29,894	45,500	45,500	37,418	158,311	12,402	45,500	45,500	20,841	124,243	-	-	-	-	-
Ag	g/t	599	588	581	783	412	177	495	393	803	766	716	734	-	-	-	-	-
Ag Contained	kg	181,374	11,789	17,359	35,634	18,754	6,625	78,373	4,871	36,552	34,869	14,921	91,213	-	-	-	-	-
<b>ROM Sulphide</b>																		
Mass	t	41,931	-	-	-	-	8,833	8,833	33,098	-	-	-	-	33,098	-	-	-	-
Ag	g/t	690	-	-	-	-	762	762	671	-	-	-	-	671	-	-	-	-
Ag Contained	kg	28,943	-	-	-	-	6,729	6,729	22,214	-	-	-	-	22,214	-	-	-	-
<b>Total Feed</b>																		
Mass	t	344,525	20,039	29,894	45,500	45,500	46,251	167,145	45,500	45,500	45,500	20,841	157,341	-	-	-	-	-
Ag	g/t	610	588	581	783	412	289	509	595	803	766	716	721	-	-	-	-	-
Ag Contained	kg	210,317	11,789	17,359	35,634	18,754	13,354	85,102	27,084	36,552	34,869	14,921	113,426	-	-	-	-	-
Sulphides in Blend	%	12.2%	0.0%	0.0%	0.0%	0.0%	19.1%	5.3%	72.7%	0.0%	0.0%	0.0%	21.0%	0.0%	0.0%	0.0%	0.0%	0.0%
<b>FLOTATION PLANT STREAM</b>																		
<b>ROM Sulphide</b>																		
Mass	t	1,362,739	-	-	-	-	-	-	-	-	-	47,340	47,340	272,720	272,720	272,720	272,720	224,519
Ag	g/t	457	-	-	-	-	-	-	-	-	-	641	641	451	394	428	428	460
Ag Contained	kg	622,435	-	-	-	-	-	-	-	-	-	30,325	30,325	141,735	122,917	107,635	116,601	103,322
Pb	%	72,213	-	-	-	-	-	-	-	-	-	2.31	2.31	4.30	5.31	2.37	1.59	3.04
Pb Contained	kg	44,948,000	-	-	-	-	-	-	-	-	-	1,095,489	1,095,489	11,733,774	14,494,470	6,468,896	4,340,458	6,814,913
Zn	%	400	-	-	-	-	-	-	-	-	-	1.26	1.26	0.68	1.50	1.89	1.47	1.01
Zn Contained	kg	17,969,268	-	-	-	-	-	-	-	-	-	594,435	594,435	1,846,449	4,100,288	5,153,549	4,011,934	2,262,614
Mass Recovery		0.66	NO ORE SORTER	NO ORE SORTER	0.66	0.66	0.66	0.66	0.66	0.66	0.66	0.66	0.66	0.66	0.66	0.66	0.66	0.66
Ag Recovery		0.99	NO ORE SORTER	NO ORE SORTER	0.99	0.99	0.99	0.99	0.99	0.99	0.99	0.99	0.99	0.99	0.99	0.99	0.99	0.99
Pb Recovery		0.99	NO ORE SORTER	NO ORE SORTER	0.99	0.99	0.99	0.99	0.99	0.99	0.99	0.99	0.99	0.99	0.99	0.99	0.99	0.99
Zn Recovery		0.99	NO ORE SORTER	NO ORE SORTER	0.99	0.99	0.99	0.99	0.99	0.99	0.99	0.99	0.99	0.99	0.99	0.99	0.99	0.99

6. PROCESS PLANT FEED

LEACH PLANT STREAM																		
<b>Off Balance Oxide</b>																		
Mass	t	29,806	-	-	434	9,223	20,148	29,806	-	-	-	-	-	-	-	-	-	-
Ag	g/t	223	-	-	223	223	223	223	-	-	-	-	-	-	-	-	-	-
Ag Contained	kg	6,642	-	-	97	2,055	4,490	6,642	-	-	-	-	-	-	-	-	-	-
<b>ROM Oxide</b>																		
Mass	t	186,884	20,039	29,894	29,595	20,807	4,547	84,844	8,185	30,030	30,030	13,755	82,001	-	-	-	-	-
Ag	g/t	927	588	581	1,189	794	455	838	589	1,205	1,150	1,074	1,101	-	-	-	-	-
Ag Contained	kg	173,209	11,789	17,359	35,181	16,512	2,068	71,120	4,822	36,187	34,520	14,772	90,301	-	-	-	-	-
<b>Total Oxide</b>																		
Mass	t	216,689	20,039	29,894	30,030	30,030	24,696	114,650	8,185	30,030	30,030	13,755	82,001	-	-	-	-	-
Ag	g/t	830	588	581	1,175	618	266	678	589	1,205	1,150	1,074	1,101	-	-	-	-	-
Ag Contained	kg	179,852	11,789	17,359	35,278	18,567	6,558	77,763	4,822	36,187	34,520	14,772	90,301	-	-	-	-	-
<b>ROM Sulphide</b>																		
Mass	t	27,675	-	-	-	-	5,830	5,830	21,845	-	-	-	-	21,845	-	-	-	-
Ag	g/t	1,035	-	-	-	-	1,143	1,143	1,007	-	-	-	-	1,007	-	-	-	-
Ag Contained	kg	28,654	-	-	-	-	6,662	6,662	21,992	-	-	-	-	21,992	-	-	-	-
<b>Total Feed</b>																		
Mass	t	244,364	20,039	29,894	30,030	30,030	30,526	120,479	30,030	30,030	30,030	13,755	103,845	-	-	-	-	-
Ag	g/t	853	588	581	1,175	618	433	701	893	1,205	1,150	1,074	1,081	-	-	-	-	-
Ag Contained	kg	208,505	11,789	17,359	35,278	18,567	13,220	84,425	26,813	36,187	34,520	14,772	112,292	-	-	-	-	-
Sulphides in Blend	%	11.3%	0.0%	0.0%	0.0%	0.0%	19.1%	4.8%	72.7%	0.0%	0.0%	0.0%	21.0%	0.0%	0.0%	0.0%	0.0%	0.0%
<b>FLOTATION PLANT STREAM</b>																		
<b>ROM Sulphide</b>																		
Mass	t	899,408	-	-	-	-	-	-	-	-	-	31,244	31,244	179,995	179,995	179,995	179,995	148,182
Ag	g/t	685	-	-	-	-	-	-	-	-	-	961	961	780	676	591	641	690
Ag Contained	kg	616,211	-	-	-	-	-	-	-	-	-	30,022	30,022	140,317	121,688	106,459	115,435	102,289
Pb	%	4.95	-	-	-	-	-	-	-	-	-	3.47	3.47	6.45	7.97	3.56	2.39	4.55
Pb Contained	kg	44,498,520	-	-	-	-	-	-	-	-	-	1,084,534	1,084,534	11,616,436	14,349,525	6,404,207	4,297,054	6,746,764
Zn	%	2.89	-	-	-	-	-	-	-	-	-	1.88	1.88	1.02	2.26	2.83	2.21	1.51
Zn Contained	kg	17,789,576	-	-	-	-	-	-	-	-	-	588,490	588,490	1,827,984	4,059,285	5,102,013	3,971,815	2,239,988

			Бортовое содержание серебра, g/t				75				150				250				
Processing Opex for Primary Ore																			
No.	Item	Units измерения (удельные / годовые)	Цена, RUB	Production rate, t/year				180,000				180,000				180,000			
				Specific consumption		Annual consumption		Specific consumption		Annual consumption		Specific consumption		Annual consumption		Specific consumption		Annual consumption	
				normal rate	RUB/t	normal rate	thous.RUB	normal rate	RUB/t	normal rate	thous.RUB	normal rate	RUB/t	normal rate	thous.RUB	normal rate	RUB/t	normal rate	thous.RUB
<b>1</b>	<b>auxiliary materials - Total, incl.:</b>				<b>136.23</b>		<b>24,522</b>		<b>136.23</b>		<b>24,522</b>		<b>136.23</b>		<b>24,522</b>		<b>136.23</b>		<b>24,522</b>
1.1	crusher lining	кг / м	75	0.04	3.00	7.20	540	0.04	3.00	7.20	540	0.04	3.00	7.20	540	0.04	3.00	7.20	540
1.2	mill lining (rubber)	кг / м	300	0.10	30.00	18.0	5,400	0.10	30.00	18.0	5,400	0.10	30.00	18.0	5,400	0.10	30.00	18.0	5,400
1.3	balls 80 мм	кг / м	57	0.9	51.62	162	9,291	0.9	51.62	162	9,291	0.9	51.62	162	9,291	0.9	51.62	162	9,291
1.4	balls 40 мм	кг / м	57	0.9	51.62	162	9,291	0.9	51.62	162	9,291	0.9	51.62	162	9,291	0.9	51.62	162	9,291
<b>2</b>	<b>Total for reagents, incl.:</b>				<b>455.44</b>		<b>81,980</b>		<b>455.44</b>		<b>81,980</b>		<b>455.44</b>		<b>81,980</b>		<b>455.44</b>		<b>81,980</b>
2.1	hydrated lime	кг / м	11	6.87	75.52	1,236	13,594	6.87	75.52	1,236	13,594	6.87	75.52	1,236	13,594	6.87	75.52	1,236	13,594
2.2	zinc sulphate	кг / м	180	0.38	69.23	69.2	12,462	0.38	69.23	69.2	12,462	0.38	69.23	69.2	12,462	0.38	69.23	69.2	12,462
2.3	Aerophine 3418	кг / м	245	0.03	7.35	5.40	1,323	0.03	7.35	5.40	1,323	0.03	7.35	5.40	1,323	0.03	7.35	5.40	1,323
2.4	T-92	кг / м	25	0.05	1.25	9.00	225	0.05	1.25	9.00	225	0.05	1.25	9.00	225	0.05	1.25	9.00	225
2.5	butyl xanthate	кг / м	140	0.07	9.33	12.0	1,680	0.07	9.33	12.0	1,680	0.07	9.33	12.0	1,680	0.07	9.33	12.0	1,680
2.6	flotation pine oil	кг / м	275	0.02	5.78	3.78	1,040	0.02	5.78	3.78	1,040	0.02	5.78	3.78	1,040	0.02	5.78	3.78	1,040
2.7	liquid glass	кг / м	15	0.40	6.00	72.0	1,080	0.40	6.00	72.0	1,080	0.40	6.00	72.0	1,080	0.40	6.00	72.0	1,080
2.8	copper sulphate	кг / м	104	0.30	31.20	54.0	5,616	0.30	31.20	54.0	5,616	0.30	31.20	54.0	5,616	0.30	31.20	54.0	5,616
2.10	floculant Magnafloc 10	кг / м	278	0.100	27.78	18.0	5,001	0.100	27.78	18.0	5,001	0.100	27.78	18.0	5,001	0.100	27.78	18.0	5,001
2.11	sodium cyanide	кг / м	178	0.50	89.00	90.0	16,020	0.50	89.00	90	16,020	0.50	89.00	90	16,020	0.50	89.00	90	16,020
2.12	calcium hypochlorite	кг / м	70	0.50	35.00	90	6,300	0.50	35.00	90	6,300	0.50	35.00	90	6,300	0.50	35.00	90	6,300
2.13	ferrous sulfate	кг / м	14	7.00	98.00	1,260	17,640	7.00	98.00	1,260	17,640	7.00	98.00	1,260	17,640	7.00	98.00	1,260	17,640
<b>3</b>	<b>Total for energy resources, incl.:</b>				<b>537.83</b>		<b>96,809</b>		<b>537.83</b>		<b>96,809</b>		<b>537.83</b>		<b>96,809</b>		<b>537.83</b>		<b>96,809</b>
3.1	Diesel fuel	л / тыс. л																	
	electrical energy	кВт*ч / тыс. кВт*ч	4.69	114.68	537.83	20,642	96,809	114.68	537.83	20,642	96,809	114.68	537.83	20,642	96,809	114.68	537.83	20,642	96,809
	transportation services	0			203.55		36,639		203.55		36,639		203.55		36,639		203.55		36,639
4	Technical staff salary				720.00		129,600		720.00		129,600		720.00		129,600		720.00		129,600
5	deductions to social insurance				217.44		39,139		217.44		39,139		217.44		39,139		217.44		39,139
6	Depreciation				418.68		75,363		418.68		75,363		418.68		75,363		418.68		75,363
7	spare-parts pool				314.01		56,522		314.01		56,522		314.01		56,522		314.01		56,522
8	shop's expenses				468.72		84,370		468.72		84,370		468.72		84,370		468.72		84,370
	<b>Total</b>				<b>3,471.91</b>		<b>624,943</b>		<b>3,471.91</b>		<b>624,943</b>		<b>3,471.91</b>		<b>624,943</b>		<b>3,471.91</b>		<b>624,943</b>
	same without depreciation				3,053.23		549,581		3,053.23		549,581		3,053.23		549,581		3,053.23		549,581
<b>same without depreciation , USD</b>					<b>47.18</b>				<b>47.18</b>				<b>47.18</b>				<b>47.18</b>		

**Ore sorting operating cost**

US\$/t ore treated

2.25

1. Salary of sorting stuff ( 2+2 person ) near 100 K\$ per year

2. Electricity. SBR has checked design documentation, sorting complex designed for electricity consumption 250Kw per hour. Using YGK partial cost return for electricity in Yakutia, consider 1kw/h cost 10 cents. In total 76800\$ per 3200 working hours of XRT complex.

3. Maintenance and repair. I had check spare and wear part for 1 year from steinert, part cost is 14,971Euro , but we do not know costs for maintenance work in case we will use steinert engineers. So, my suggestion make estimate something near 100K\$ per year

4. Costs of diesel fuel and work time of loader. In practice can use the same loader working on the ore crushing now but it will work more intensively. Currently assume working at 30% of possible performance. So fuel consumption for loader and maintenance and repair costs will increase but SBR is not sure how to estimate it properly. But it is understood the loader fuel consumption approximates 20l of diesel per hour or 20\$ per hour for fuel. Consider for estimation 3200 hours per year loader work just for xrt sorter and fuel consumption 64000\$.

5. There is no additional costs per ore transportation from open pit, because now we also transport ore, but there will be some additional costs for tails transportation. 80 000 tons of tail is something near 20K\$.

100K\$+76800\$+100K\$+64K\$+20K\$=360 800. If we consider XRT performance 160 000 t of ore to the process plant 360 800/160 000= 2,25\$

64.71

**Processing Capex for Primary Ore**

No.	Item	Model	Price, thous.Rub	Processing flowsheet		Power Consumption, kW	
				Qty	Cost, thous.Rub	Units	Total
1	Технологическое оборудование, в том числе:				<b>753,625</b>		<b>1200</b>
1.1	Base case crusher	ЩД-1-5x9	14,858	2	29,717	55	110
1.2	Base case cone crusher	СМД-120А-Р-200	11,413	2	22,825	55	110
1.3	Ball mill	МШЦ 3,9x3,0	91,373	2	182,747	500	1000
1.5	conditioning tank	КЧ-4	250	1	250	18.5	18.5
1.6	Flotation cell	РИФ-1,5	3,500	14	49,000	7	98
1.7	Filter press (Pb KТ)	OUTOTEC Larox 800x800 (17	16,000	1	16,000	18.5	18.5
1.8	Filter press (Zn KТ)	OUTOTEC Larox 800x800 (33	20,000	1	20,000	18.5	18.5
1.9	conditioning tank	КЧР-0,8А	130	1	130	1.5	1.5
1.10	Cyanidation tank with me	70 м <sup>3</sup>	1,150	4	4,600	11	44
1.11	Radial thickener	СЦ-2,5А	1,000	1	1,000	0.75	0.75
1.12	Filter press (кек)	OUTOTEC Larox 800x800 (33	20,000	1	20,000	18.5	18.5
1.16	Electrowinning unit	emew PLANT	183,939	1	183,939	375	32
1.17	Filter press (хвооты)	ВИЛФИНГЕР ME1500.3500 (33	28,938	3	86,813	19.6	58.8
1.18	Radial thickener	СЦ-15	11,000	1	11,000	4	4
1.19	unaccounted equipment and metal structures				125,604		
2	plumping and electrical engineering				60,290		
3	Automation				75,363		
	<b>Total for equipment</b>				<b>889,278</b>		<b>13,743</b>
4	transportation costs				35,571		550
	<b>Equipment + delivery</b>				<b>924,849</b>		<b>14,292</b>
5	building and installation work				184,970		2,858
6	commissioning				46,242		715
	<b>Total for capital investments</b>				<b>1,156,061</b>		<b>17,865</b>
	Complementary to existing				224,541		3,470

Thous US\$

## Version per SRK and ERM:

Period	Nominal	Inflated	PV OB	Accretion	Payment	PV EB	LOM	Inflation	Discount rate
31/12/2017	87,622	148,301				54,212	11	4.90%	8.64%
31/12/2018	91,127	134,891	54,212	4,684	0	58,896	10	4.00%	8.64%
31/12/2019	94,772	134,891	58,896	5,089	0	63,984	9	4.00%	8.64%
31/12/2020	98,563	134,891	63,984	5,528	0	69,513	8	4.00%	8.64%
31/12/2021	102,506	134,891	69,513	6,006	0	75,518	7	4.00%	8.64%
31/12/2022	106,606	134,891	75,518	6,525	0	82,043	6	4.00%	8.64%
31/12/2023	110,870	134,891	82,043	7,089	0	89,132	5	4.00%	8.64%
31/12/2024	115,305	134,891	89,132	7,701	0	96,833	4	4.00%	8.64%
31/12/2025	119,917	134,891	96,833	8,366	0	105,199	3	4.00%	8.64%
31/12/2026	124,714	134,891	105,199	9,089	0	114,288	2	4.00%	8.64%
31/12/2027	129,702	134,891	114,288	9,875	0	124,163	1	4.00%	8.64%
31/12/2028	134,891	134,891	124,163	10,728	(134,891)	(0)	0	4.00%	8.64%

## Version per EMS:

Period	Nominal	Inflated	PV OB	Accretion	Payment	PV EB	LOM	Inflation	Discount rate
31/12/2017	219,325	371,209				125,459	11	4.90%	8.64%
31/12/2018	228,098	337,641	125,459	10,840	0	136,298	10	4.00%	8.64%
31/12/2019	237,222	337,641	136,298	11,776	0	148,075	9	4.00%	8.64%
31/12/2020	246,711	337,641	148,075	12,794	0	160,868	8	4.00%	8.64%
31/12/2021	256,579	337,641	160,868	13,899	0	174,767	7	4.00%	8.64%
31/12/2022	266,842	337,641	174,767	15,100	0	189,867	6	4.00%	8.64%
31/12/2023	277,516	337,641	189,867	16,405	0	206,272	5	4.00%	8.64%
31/12/2024	288,617	337,641	206,272	17,822	0	224,093	4	4.00%	8.64%
31/12/2025	300,161	337,641	224,093	19,362	0	243,455	3	4.00%	8.64%
31/12/2026	312,168	337,641	243,455	21,035	0	264,490	2	4.00%	8.64%
31/12/2027	312,168	312,168	264,490	22,852	0	287,342	1		
31/12/2028	312,168	312,168	287,342	0	(312,168)	(24,826)	0		

ARO liability estimate:	2017	2018	2019	2020	2021	2022	2023	2024	2025	2026	2027	2028
Discount rate	7.70%	8.64%	6.41%	6.41%	6.41%	6.41%	6.41%	6.41%	6.41%			
Inflation rate	4.90%	4.00%	4.00%	4.00%	4.00%	4.00%	4.00%	4.00%	4.00%			
LOM-end year	2028	2028	2028	2028	2028	2028	2028	2028	2028	2028	2028	2028

Reporting period	2017	2018	2019	2020	2021	2022	2023	2024	2025	2026	2027	2028
LOM-end year	2028	2028	2028	2028	2028	2028	2028	2028	2028	2028	2028	2028

	<i>in kRUB</i>	<i>in kRUB</i>	<i>in kRUB</i>	<i>in kRUB</i>	<i>in kRUB</i>	<i>in kRUB</i>	<i>in kRUB</i>	<i>in kRUB</i>	<i>in kRUB</i>	<i>in kRUB</i>	<i>in kRUB</i>	<i>in kRUB</i>
Nominal value	219,325	228,098	237,222	246,711	256,579	266,842	277,516	288,617	300,161	300,161	300,161	300,161
Inflated value	371,209	337,641	337,641	337,641	337,641	337,641	337,641	337,641	337,641	300,161	300,161	300,161
Discounted value	164,152	147,420	193,025	205,398	218,564	232,573	247,481	263,345	280,225	300,161	300,161	300,161

	<i>in kRUB</i>	<i>in kRUB</i>	<i>in kRUB</i>	<i>in kRUB</i>	<i>in kRUB</i>	<i>in kRUB</i>	<i>in kRUB</i>	<i>in kRUB</i>	<i>in kRUB</i>	<i>in kRUB</i>	<i>in kRUB</i>	<i>in kRUB</i>
OB	48,239	65,580	56,631	193,025	205,398	218,564	232,573	247,481	263,345	280,225	300,161	300,161
Unwinding of discount	4,027	5,050	4,893	12,373	13,166	14,010	14,908	15,864	16,880	17,962	0	0
Change in underlying value	13,314		84,090									
Change in estimate		(13,999)	47,411	(0)	(0)	0	0	0	0	1,974	0	0
EB	65,580	56,631	193,025	205,398	218,564	232,573	247,481	263,345	280,225	300,161	300,161	300,161

## Change in estimate effects:

Additions			84,090									
Change in assumptions		(13,999)	47,411	(0)	(0)	0	0	0	0	1,974	0	0
Change in estimate total		(13,999)	131,501	(0)	(0)	0	0	0	0	1,974	0	0

ARO asset estimate	2017	2018	2019	2020	2021	2022	2023	2024	2025	2026	2027	2028
OB	48,239	61,554	47,554	179,056	179,056	179,056	179,056	179,056	179,056	179,056	181,029	181,029
Additions	13,314		84,090									
Change in estimate		(13,999)	47,411	(0)	(0)	0	-	-	-	1,974	-	-
EB	61,554	47,554	179,056	179,056	179,056	179,056	179,056	179,056	179,056	181,029	181,029	181,029

## Accumulated depletion

OB		(4,385)	(8,771)	(12,649)	(31,139)	(49,628)	(68,118)	(86,608)	(105,097)	(123,587)	(142,076)	(160,566)
Charge for the year	(4,385)	(4,385)	(3,878)	(18,490)	(18,490)	(18,490)	(18,490)	(18,490)	(18,490)	(18,490)	(18,490)	(18,490)
EB	(4,385)	(8,771)	(12,649)	(31,139)	(49,628)	(68,118)	(86,608)	(105,097)	(123,587)	(142,076)	(160,566)	(179,056)

## Net book value

OB	48,239	57,168	38,784	166,406	147,917	129,427	110,938	92,448	73,958	55,469	38,953	20,463
EB	57,168	38,784	166,406	147,917	129,427	110,938	92,448	73,958	55,469	38,953	20,463	1,974



Prognoz ARO

Provision for decommissioning and restoration liability

Activity	Source	Nominal, kRUB	Nominal, \$k	\$m
				60.00
<b>PY</b>				
Explosive storage	ERM PY	287	5	
Main fuel farm	ERM PY	18,522	309	
Temp fuel storage	ERM PY	1,406	23	
Endybal airstrip	ERM PY	489	8	
Fleet demobilisation	ERM PY	3,957	66	
Hogin mancamp	ERM PY	15,690	262	
Endybal decommissioning	ERM PY	4,957	83	
Hogin sawmill	ERM PY	606	10	
Boreholes, pump stations	ERM PY	4,174	70	
Waste disposal	ERM PY	2,485	41	
				0.88
<b>ADJs:</b>				
Less: airstrip (no need)	Estimate	(489)	(8)	
Less: fleet demobilisation (accounted in sale surplus)	Estimate	(3,957)	(66)	
Less: fuel tanks freight (no need)	Estimate	(18,150)	(303)	
Less: mancamp freight (no need)	Estimate	(14,025)	(234)	
				(0.61)
<b>PIT</b>				
Fencing & re-seeding pit rims	SRK adjusted	2,000	33	
Channel excavation, control and engineering works, allow	SRK adjusted	3,240	54	
Design and site supervision	SRK adjusted	1,200	20	
Waste rock dumps/stockpiles re-contouring, soil replacement	SRK adjusted	9,771	163	
				0.27
<b>TMF</b>				
Re-contouring, capping, re-seeding	SRK adjusted	4,320	72	
Operation, maintenance and removal of pumps and other items	SRK adjusted	600	10	
Design and supervision, allow	SRK adjusted	1,200	20	
				0.10
<b>PLANT</b>				
Cleaning of process equipment	SRK adjusted	3,000	50	
Treatment of effluent	SRK adjusted	3,000	50	
Dismantling equipment, salvage or disposal of equipment	SRK adjusted	9,180	153	
Dismantling drainage system and hard standing	SRK adjusted	3,960	66	
Testing for contamination	SRK adjusted	3,000	50	
Preparation of surface	SRK adjusted	3,000	50	
				0.42
<b>OTHER</b>				
Post closure fund for sustainable development	SRK adjusted	2,000	33	
Monitoring of TMF, allow \$10,000 for 5 years	SRK adjusted	3,000	50	
Staff redundancies etc	Estimate	15,000	250	
Insurance	SRK adjusted	1,200	20	
Contingency	SRK adjusted	3,000	50	
				0.40
<b>Total</b>		<b>87,622</b>	<b>1,460</b>	<b>1.46</b>

Макроэкономический прогноз (апдейт) на 2020, 2021-2030 гг.

№	Параметр	2019	2020F	2021F	2022F	2023F	2024F	2025F	2026F	2027F	2028F	2029F	2030F
1	<b>Сценарий 1. БАЗОВЫЙ</b>												
2	Цена на нефть Brent	\$65	\$36	\$50	\$55	\$60	\$61	\$62	\$64	\$65	\$66	\$68	\$69
3	USD/RUB (среднее за год)	64.7	72.1	70.0	70.0	70.0	71.4	72.8	74.2	75.7	77.1	78.6	80.2
4	USD/RUB (конец года)	62.3	70.0	70.0	70.0	70.0	71.4	72.8	74.2	75.7	77.1	78.6	80.2
5	Потребительская инфляция в РФ, среднее за год, %	4.5%	4.7%	4.0%	4.0%	4.0%	4.0%	4.0%	4.0%	4.0%	4.0%	4.0%	4.0%
6	EUR/USD (средний)	1.12	1.10	1.10	1.12	1.15	1.18	1.20	1.22	1.22	1.22	1.23	1.23
7	EUR/USD (на конец года)	1.11	1.10	1.10	1.12	1.15	1.18	1.20	1.22	1.22	1.22	1.23	1.23
8	EUR/RUB (средний)	72.5	79.3	77.0	78.6	80.5	84.2	87.3	90.5	92.5	94.5	96.5	98.6
9	EUR/RUB (на конец года)	69.1	77.0	77.0	78.6	80.5	84.2	87.3	90.5	92.5	94.5	96.5	98.6
10	<b>Справочно: предыдущий прогноз для СБП</b>												
11	Цена на нефть Brent	\$65	\$62	\$64	\$64	\$65	\$66	\$67	\$69	\$70	\$71	\$73	\$74
12	USD/RUB (средний за год)	64.7	63.1	66.1	66.5	66.9	67.4	68.7	70.1	71.4	72.8	74.3	75.7
13	Потребительская инфляция в РФ, среднее за год, %	4.5%	3.0%	3.7%	4.0%	4.0%	4.0%	4.0%	4.0%	4.0%	4.0%	4.0%	4.0%
14	EUR/USD	1.11	1.12	1.15	1.18	1.20	1.22	1.22	1.22	1.23	1.23	1.23	1.23
15	<b>Сценарий 2. Низкие цены на нефть</b>												
16	Цена на нефть Brent	\$65	\$30	\$32	\$35	\$40	\$40	\$40	\$41	\$42	\$42	\$43	\$44
17	USD/RUB (средний за год)	64.7	81.0	78.0	77.0	75.0	76.5	78.0	79.5	81.1	82.6	84.3	85.9
18	Потребительская инфляция в РФ, среднее за год, %	4.5%	6.8%	4.0%	4.0%	4.0%	4.0%	4.0%	4.0%	4.0%	4.0%	4.0%	4.0%

Источник: оценки управления корпоративной стратегии на основе прогнозов аналитиков

Ag	\$/oz	17.76
Pb	\$/t	2,069
Zn	\$/t	2,252

SP Angel Report, published in Aug 2019

World Bank CMO October 2019		2017	2018	2019	2020	2021	2022	2023	2025	2030
Lead	\$/mt	2,315	2,240	1,970	1,950	1,965	1,979	1,979	2,024	2,100
Zinc	\$/mt	2,891	2,922	2,570	2,450	2,455	2,460	2,460	2,475	2,500
Silver	\$/toz	17.10	15.70	16.20	17.00	17.00	17.00	17.00	17.00	17.00

World Bank CMO April 2020		2017	2018	2019	2020	2021	2022	2023	2025	2030
Silver	\$/toz	17.10	15.70	16.20	16.80	17.00	17.10	17.20	17.40	18.00
Lead	\$/mt	2,315	2,240	1,997	1,700	1,800	1,831	1,863	1,928	2,100
Zinc	\$/mt	2,891	2,922	2,550	1,900	2,000	2,050	2,102	2,209	2,500

**STOKE-ON-TRENT**

Sir Henry Doulton House  
Forge Lane  
Etruria  
Stoke-on-Trent  
ST1 5BD  
Tel: +44 (0)1782 276 700

**BIRMINGHAM**

Two Devon Way  
Longbridge Technology Park  
Longbridge  
Birmingham  
B31 2TS  
Tel: +44 (0)121 580 0909

**BOLTON**

41-50 Futura Park  
Aspinall Way  
Middlebrook  
Bolton  
BL6 6SU  
Tel: +44 (0)1204 227 227

**CARDIFF**

Tudor House  
16 Cathedral Road  
Cardiff  
CF11 9LJ  
Tel: +44 (0)292 072 9191

**CARLISLE**

Marconi Road  
Burgh Road Industrial Estate  
Carlisle  
Cumbria  
CA2 7NA  
Tel: +44 (0)1228 550 575

**EDINBURGH**

Great Michael House  
14 Links Place  
Edinburgh  
EH6 7EZ  
Tel: +44 (0)131 555 3311

**GLASGOW**

2 West Regent Street  
Glasgow  
G2 1RW  
Tel: +44 (0)141 433 7210

**LEEDS**

36 Park Row  
Leeds  
LS1 5JL  
Tel: +44 (0)113 831 5533

**LONDON**

Third Floor  
46 Chancery Lane  
London  
WC2A 1JE  
Tel: +44 (0)207 242 3243

**MANCHESTER**

76 King Street  
Manchester  
M2 4NH  
Tel: +44 (0)161 817 5038

**NEWCASTLE UPON TYNE**

City Quadrant  
11 Waterloo Square  
Newcastle upon Tyne  
NE1 4DP  
Tel: +44 (0)191 232 0943

**TRURO**

Baldhu House  
Wheal Jane Earth Science Park  
Baldhu  
Truro  
TR3 6EH  
Tel: +44 (0)187 256 0738

**International offices:**

**ALMATY**

29/6 Satpaev Avenue  
Regency Hotel  
Office Tower  
Almaty  
Kazakhstan  
050040  
Tel: +7(727) 334 1310

**MOSCOW**

21/5 Kuznetskiy Most St.  
Moscow  
Russia  
Tel: +7(495) 626 07 67